

Ø0.00mm to Ø2.70mm (10.5cm), Brass

VALUE



- 2 collets
- Square head
- Length 10.5cm
- Knurled brass handle
- Second collet stored in handle

Code	Description	UOM	Price
V39484	Ø0.00mm to Ø2.70mm (10.5cm), Brass	EACH	£2.95

Single Ended (Square) with 2 Collets, A*F Swiss



Pin Vices - Square Head - Single End - 2 Collets - A*F Swiss

- A*F Swiss
- Single Ended
- 2 Tempered Steel Collets
- Various Lengths (in brackets)
- Square Head
- Knurled Handle
- Brass

Code	Description	UOM	Price
V47207	Pin Vice Set (7 - 9 - 11 - 13cm)	PACK*4	£29.95
P1214	Ø0.00mm to Ø1.75mm (7cm)	EACH	£6.45
P1215	Ø0.00mm to Ø2.35mm (9cm)	EACH	£6.95
P1216	Ø0.00mm to Ø3.25mm (11cm)	EACH	£7.50
P1217	Ø0.00mm to Ø4.25mm (13cm)	EACH	£10.50

Single Ended (Round) with 2 Collets, A*F Swiss



Pin Vices - Round Head - Single End - 2 Collets - A*F Swiss

- A*F Swiss
- Single Ended
- 2 Tempered Steel Collets
- Various Lengths (in brackets)
- Round Head
- Knurled Handle
- Brass

Code	Description	UOM	Price
V47201	Ø0.00mm to Ø1.75mm (7cm)	EACH	£6.15

V47202	Ø0.00mm to Ø2.00mm (8cm)	EACH	£6.15
V47203	Ø0.00mm to Ø2.80mm (9cm)	EACH	£6.85
V47204	Ø0.00mm to Ø3.35mm (10cm)	EACH	£8.75
V47205	Ø0.00mm to Ø3.65mm (11cm)	EACH	£8.95
V47206	Ø0.00mm to Ø3.90mm (12cm)	EACH	£10.30

Single Ended (Round) with 2 Collets, Bergeon Swiss



Pin Vices - Round Head - Single End - 2 Collets - Bergeon 3002X-X

- Round head with 2 collets
- Various Lengths (in brackets)
- Chucks of hardened steel
- Chromium plated handles
- Set is our code P4306

Code	Description	UOM	Price
P49992	Ø0.00 to Ø0.50mm (8cm)	EACH	£27.95
P49993	Ø0.00 to Ø2.00mm (9cm)	EACH	£29.95
P49994	Ø1.00 to Ø2.00mm (10cm)	EACH	£29.95
P49995	Ø2.00 to Ø3.00mm (12cm)	EACH	£29.95
P49996	Ø3.00 to Ø4.00mm (13cm)	EACH	£31.95

Pin Vices, Sets

Pin Vices - Sets

Pin vice sets prove to be very useful in your busy workshop by having many sizes ready available to hand.

Ideal for holding small tools including drills, broaches and burnishers plus for holding materials for working on including rods and wires.

Swiss and non Swiss sets available

Eclipse (1 Collet)



Neill tools - Pack of 4 - Eclipse Pin Vices

- Hollow body & holes in both ends
- Any length material can be held
- Steel
- Hardened Steel Jaws
- For replacements see from code P49424
- Made in UK

Contains:
• Ø0 to Ø1.00mm

- Ø0.75 to Ø1.50mm
- Ø1.25 to Ø3.00mm
- Ø2.75 to Ø5.00mm

Code	Description	UOM	Price
P49422	Eclipse Set (Ø0 to Ø5.00mm)	PACK*4	£64.95

Eclipse Style (1 Collet)

VALUE



Pack of 4 - Eclipse Style

- Hollow body & holes in both ends
- Any length material can be held
- Steel
- Made in India

Contains:
• Ø0 to Ø1.00mm
• Ø0.75 to Ø1.50mm
• Ø1.25 to Ø3.00mm
• Ø2.75 to Ø5.00mm

Code	Description	UOM	Price
P49421	Eclipse Style Set (Ø0 to Ø5.00mm)	PACK*4	£4.95

Eclipse Style, A*F Swiss



A*F Swiss - Pack of 4 - Eclipse Style

- Hollow body & holes in both ends
- Any length material can be held
- Blued Steel
- Hardened Steel Jaws
- For replacements see from code V47209

Contains:
• Ø0 to Ø1.00mm
• Ø0.75 to Ø1.50mm
• Ø1.25 to Ø3.00mm
• Ø2.75 to Ø5.00mm

Code	Description	UOM	Price
V47208	Eclipse Style Set (Ø0 to Ø5.00mm)	PACK*4	£16.95



Square Head (2 Collets), Bergeon



Bergeon 1842B - Swiss Made

- Square Head with 2 Collets
- Handle in nicked plated brass
- Various Lengths (in brackets)

Set of 4:

- No. 1 = Ø0 to Ø1.00mm & Ø0.80 to Ø2.00mm (8cm)
- No. 2 = Ø0 to Ø1.20mm & Ø1.50 to 3.00mm (10cm)
- No. 3 = Ø0 to Ø1.50mm & Ø2.50 to Ø4.00mm (12cm)
- No. 4 = Ø0 to Ø1.50mm & Ø4.00 to Ø5.00mm (14cm)

Code	Description	UOM	Price
P1210	Square Head (2 Collets) Bergeon 1842B	PACK*4	£59.95

Square Head (2 Collets) Superior Quality



Set of 4:

- Ø0 to Ø1.60mm & Ø0 to Ø0.60mm (7.5cm)
- Ø0 to Ø1.90mm & Ø1.20 to Ø2.15mm (9cm)
- Ø0 to Ø2.40mm & Ø1.50 to Ø2.75mm (11cm)
- Ø0 to Ø3.30mm & Ø2.00 to Ø3.00mm (14cm)
- Square Head with 2 Collets
- Various Lengths (in brackets)
- Brass
- Superior Quality.

Code	Description	UOM	Price
P36941	Square Head (2 Collets) Far East	PACK*4	£15.95

Square Head (2 Collets)



Set of 6:

- No. 1 = Ø0 to Ø0.50mm & Ø0.50 to Ø1.60mm (7cm)
- No. 2 = Ø0 to Ø1.00mm & Ø1.00 to Ø2.00mm (8cm)
- No. 3 = Ø0 to Ø1.50mm & Ø1.50 to Ø2.00mm (9cm)
- No. 4 = Ø0 to Ø1.65mm & Ø1.65 to Ø3.00mm (10cm)

- No. 5 = Ø0 to Ø1.75mm & Ø2.10 to Ø3.10mm (11cm)
- No. 6 = Ø0 to Ø1.85mm & Ø2.40 to Ø3.70mm (12cm)
- Square head with 2 collets
- Various Lengths (in brackets)
- Knurled handles
- In smart plastic wallet
- Made in India

Code	Description	UOM	Price
P37127	Square Head (2 Collets) Indian	PACK*6	£12.50

Round Head (1 Collet)



Made in India

- Round head with 1 collets
- Various Lengths (in brackets)
- Chucks of hardened steel
- Black steel finish

Set of 4:

- No. 1 = Ø0 to Ø1.00mm (8cm)
- No. 2 = Ø0 to Ø2.00mm (9cm)
- No. 3 = Ø1.00 to Ø3.00mm (10cm)
- No. 4 = Ø2.50 to Ø4.00mm (10.5cm)

Code	Description	UOM	Price
P35021	Round Head (1 Collets) Indian	PACK*4	£3.00

Round Head (2 Collets), Bergeon



Bergeon 30026A - Swiss Made

- Round head with 2 collets
- Various Lengths (in brackets)
- Chucks of hardened steel
- Chromium plated handles
- In smart wooden case
- Replacements available, see from code P49992

Set of 5:

- No. 1 = Ø0 to Ø0.70mm (8cm)
- No. 2 = Ø0 to Ø1.00mm & Ø1.00 to Ø1.50mm (9cm)
- No. 3 = Ø1.00 to Ø1.50mm & Ø1.50 to Ø2.00mm (10cm)
- No. 4 = Ø2.00 to Ø2.50mm & Ø2.50 to Ø3.00mm (12cm)
- No. 5 = Ø3.00 to Ø3.50mm & Ø3.50 to Ø4.00mm (13cm)

Code	Description	UOM	Price
P4306	Round Head (2 Collets) Bergeon 30026A	PACK*5	£149.50



VICES (BENCH) & VICE JAWS

A large selection of bench vices are available. Our range is sourced from all over the world giving our customer excellent choice in price and quality.

Vices have an array of advantages which make the working process a faster and uncomplicated one in filing, tapping, hammering, soldering, forming, polishing, twisting wire/sheet, etc.

Table Top - 3/4" (15.5mm) Jaw, Precision



Precision - Table Vice - Multi Angle Support Available

- Precision vice for holding watch parts
- Sits on the table, can be moved or packed away as required
- Multi angle support table available (V52441) (see item "more info")
- Supplied with removable jaw plates in rectified, polished steel
- Replacement steel or delrin plates available
- Chromium plated brass body
- Knurled handle
- Bergeon 6876

Dimensions:

- 76 x 15 x 15mm
- Jaw width 15.5mm
- Maximum opening 9mm
- Weight 95g (with support 500g)

Code	Description	UOM	Price
V52440	Precision Vice, Bergeon 6876	EACH	£164.95
V52441	Vice Support, Bergeon 6876.S	EACH	£101.95
V52443	Delrin Plates for Precision Vice, Bergeon 6876.PD	PAIR	£34.95
V52442	Steel Plates for Precision Vice, Bergeon 6876.P	PAIR	£74.95



Clamp On - 1" (28mm) Jaw



Mini - Table Vice - Clamp On - Fixed Head

- The clamp on vice feature permits the user to move the vice to different areas of the workshop
- Portable and easy to move
- Rigid cast iron construction
- Enamelled, hand painted finish
- Made in India

Dimensions:

- 130 x 90 x 30mm
- Jaw width 28mm
- Maximum opening 26mm
- Clamp fitting table maximum 30mm
- Weight 365g

Code	Description	UOM	Price
V39595	1" Jaw, Clamp On Fixed Head "Mini" Bench Vice	EACH	£3.95

Clamp On - 1 1/2" (40mm) Jaw



Mini - Table Vice - Clamp On - Fixed Head

- The clamp on vice feature permits the user to move the vice to different areas of the workshop.
- Rigid cast iron construction.
- Enamelled, hand painted finish.
- Made in India

Dimensions:

- 120 x 40 x 120mm
- Jaw width 38mm
- Maximum opening 30mm
- Clamp fitting table maximum 35mm
- Weight 650g

Code	Description	UOM	Price
V5343	1 1/2" Jaw, Clamp On Fixed Head Bench Vice	EACH	£9.95

Clamp On - 1 1/2" (40mm) Jaw (Model Craft)



Mini Vice - Clamp On - Fixed Head - Model Craft

The mini vice is made from aluminium alloy, combining strength and lightness.

Model Craft vices are for light duty work and should only be used for craft applications

- Jaw Width: 40mm
- Jaw Capacity: 30mm
- Can be attached to benches up to 20mm thick
- Small, portable and strong
- Aluminium alloy
- Model Craft

Dimensions:

- 115 x 70 x 40mm (height x width x depth)
- Weight 350g

Code	Description	UOM	Price
V44332	1 1/2" Jaw, Clamp On Bench Vice, Model Craft	EACH	£4.95

Clamp On - 2" (50mm) Jaw, Rotating

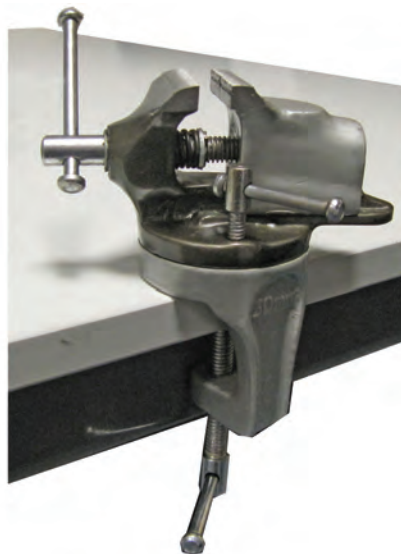

Table Vice - Clamp On - Rotating - Fixed Head

- Rotates a full 360 degrees to a workable position and then should be locked with the lever.
- The clamp on vice feature permits the user to move the vice to different areas of the workshop.
- Rigid cast iron construction.
- Enamelled, hand painted finish.
- Made in India

Dimensions:

- 140 x 60 x 130mm
- Jaw width 50mm
- Maximum opening 40mm
- Clamp fitting table maximum 35mm
- Weight 1.1kg

Code	Description	UOM	Price
V5345	2" Jaw Clamp On Rotating Head Bench Vice	EACH	£14.95

Clamp On - 2 1/2" (60mm) Jaw (Model Craft)



Bench Vice - Clamp On - Fixed Head - Model Craft

Aluminium alloy bench vice with crossed jaws. Providing a secure, strong and lightweight bench vice all in one

Model Craft vices are for light duty work and should only be used for craft applications

- Jaw Width: 60mm
- Jaw Capacity: 50mm
- Can be attached to benches up to 25mm thick
- Aluminium alloy
- Jaws have cross cut surface for better grip
- Model Craft

Dimensions:

- 140 x 120 x 60mm (height x width x depth)
- Weight 380g

Code	Description	UOM	Price
V44331	2 1/2" (60mm) Jaw, Clamp On Vice	EACH	£6.50

Clamp On - 3" (75mm) Jaw, Multi Angle



Bench Top - Multi Angle - Clamp On - Enamelled Aluminium

The ball socket manufacture of this multi-purpose vice enables complete flexibility for filing, sawing, soldering, polishing, painting models, engraving drilling and grinding.

- Jaw Width: 75mm
- Jaw Capacity (without rubber jaws): 55mm
- Jaw Capacity (with rubber jaws): 50mm
- Head Rotation: 360 degrees
- Tilt positions: 0 – 90 degrees
- The mounting clamp opens as wide as 2" which will mount on the majority of workbenches, while the rubber pad protects the bench's surface from marking
- The ball sits firmly in the socket whilst allowing the user freedom to reposition work as frequently as required
- The jaws are covered with detachable, protective inserts to avoid damaging the held pieces.
- The jaws have grooves specifically ground in to hold tube and sheet
- Made of heavy cast aluminium with an enamel-coated body and cold rolled steel screws

Dimensions:
 • 300 x 135 x 75mm
 • Weight: 1kg

Code	Description	UOM	Price
V32982	3" (75mm) Jaw, Clamp On Rotating Head Bench Vice	EACH	£16.50

3" (75mm) Jaw, Clamp On, Multi Angle (Model Craft)



Bench Top - Multi Angle - Clamp On - Model Craft

The ball socket manufacture of this multi-purpose vice enables complete flexibility for filing, sawing, soldering, polishing, painting models, engraving drilling and grinding. Giving you access to the area required all the while holding the item securely with the greatest possible ease

Model Craft vices are for light duty work and should only be used for craft applications

- Jaw Width: 75mm
- Jaw Capacity (without rubber jaws): 55mm
- Jaw Capacity (with rubber jaws): 50mm
- Head Rotation: 360 degrees
- Tilt positions: 0 – 90 degrees
- The mounting clamp opens as wide as 2.5" (65mm) which will mount on the majority of workbenches, while the rubber pad protects the bench's surface from marking
- The ball sits firmly in the socket whilst allowing the user freedom to reposition work as frequently as required
- The jaws are covered with detachable, protective inserts to avoid damaging the held pieces
- The jaws also have vertical and horizontal V-Grooves ideal for holding rods, wire or circular objects
- Die cast aluminium

• Modelcraft range

Dimensions:
 • 260 x 160 x 80mm
 • Weight: 800g

Code	Description	UOM	Price
V44305	3" (75mm) Jaw, Clamp on Rotating Head Bench Vice	EACH	£12.50

Screw Down - 1" (28mm) Jaw



Mini - Table Vice - Clamp On - Fixed Head

- Screw down vice giving permanent stability and strength
- Rigid cast iron construction
- Enamelled, hand painted finish
- Made in India

Dimensions:
 • 75 x 50 x 50mm
 • Jaw width 22mm
 • Maximum opening 20mm
 • Weight 300g

Code	Description	UOM	Price
V39594	1" Jaw, Screw On Fixed Head * Mini* Bench Vice	EACH	£3.95

Screw Down - 1 1/2" (38mm) Jaw

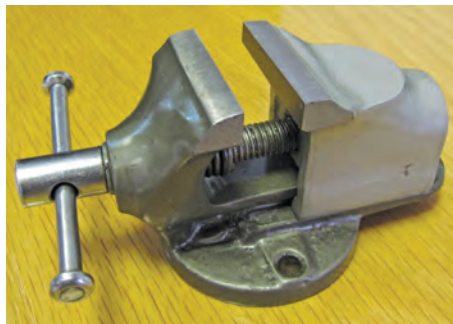

Mini - Table Vice - Screw Down - Fixed Head

- Secure on your work surface with screws bottom cast base has 2 holes
- Sturdy cast iron construction.
- Enamelled hand painted finish.
- Made in India

Dimensions:
 • 120 x 55 x 55mm
 • Jaw width 40mm
 • Maximum opening 30mm
 • Weight 610g

Code	Description	UOM	Price
V5344	1 1/2" (38mm) Jaw, Top Mount Fixed Head Bench Vice	EACH	£8.95

Screw Down - 1 3/4" (45mm) Jaw, Watchmakers

Watchmakers - Bench Vices - Removeable - Fixed Head

Precision made small vice featuring a robust bench fixable sole plate (included) and slide clamp release facility for removal of vice head (complete with job) for easy access, further work and close inspection etc.

Substantially rigid all steel manufacture with absolutely parallel 45mm wide jaws moving on a machined dovetail slide and opening to a maximum of 35mm.

A perfect partner for jewellers, watchmakers and precision engineers. Indiscernible in quality and finish from the Bergeon equivalent costing over twice the price.

Watchmakers Bench Vice



- Non Swiss
- Width of jaws 50mm
- Sizes: 110mm x 35mm x 70mm
- Jaw opening 0 to 35mm
- Very good quality
- Fawn coloured enamel (fired)
- Weight 1.1kg
- Held firmly in place by the screw down sole plate (included)
- Quick release mechanism for rapid removal from work surface
- Perfectly Smooth jaws
- Indiscernible in quality and finish from the Bergeon equivalent costing over twice the price
- Please note V1826A Vice sole plate is not compatible with this vice

Code	Description	UOM	Price
V9692	Watchmakers Bench Vice	EACH	£39.95

Watchmakers Bench Vice - Bergeon Swiss



- Bergeon 2021
- Width of jaws 45mm
- Sizes: 110mm x 35mm x 70mm
- Jaw opening 0 to 35mm
- Very fine quality
- Fawn coloured enamel (fired).

- Only the sole plate is permanently screwed on to the bench (included)
- Smooth absolutely parallel jaws
- Weight 1.2kg

Code	Description	UOM	Price
V1826	Watchmakers Bench Vice - Bergeon Swiss	EACH	£199.95

Watchmakers Bench Vice Sole Plate

- For vice V9692



Code	Description	UOM	Price
V46461	Watchmakers Bench Vice Sole Plate	EACH	£27.50

Watchmakers Bench Vice Sole Plate, Bergeon Swiss

- Bergeon 2021 (V1826)
- Replacement Sole Plate
- Weight 85g

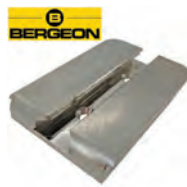

Code	Description	UOM	Price
V1826A	Watchmakers Bench Vice Sole Plate, Bergeon Swiss	EACH	£29.85

Bench Clamp for Watchmakers Vice, Horotec 24.405



- Bench Clamp for Watchmakers Vice
- Will fit our Bergeon and non branded watchmakers bench vice
- Screws into your work bench
- 60 x 60 x 50mm
- Horotec 24.405

Code	Description	UOM	Price
V55595	Bench Clamp for Watchmakers Vice, Horotec 24.405	EACH	£83.95

Screw Down - 2" (50mm) Jaw, Rotating



Table Vice - Screw Down - Rotating - Fixed Head

- Secure on your work surface with screws bottom cast base has 3 holes
- Sturdy cast iron construction
- Enamelled hand painted finish
- Made in India

- Dimensions:
- 120 x 70 x 75mm
 - Jaw width 50mm
 - Maximum opening 30mm
 - Weight 1Kg

Code	Description	UOM	Price
V36465	2" (50mm) Vice with Swival Base	EACH	£9.95

Screw Down - 4" (100mm) Jaw, Heavy Duty



Workshop Bench Vice - Heavy Duty - Screw Down - Fixed Head

A compact heavy duty workshop vice suitable for use by both the amateur and professional craftsman. The body and slide have been ground to exacting standards and feature a machined anvil and replaceable steel jaw plates. High grade ACME thread main screw with the capacity to clamp over one ton between the jaws.

A safety stop prevents the slide from being accidentally separated from the body.

- Dimensions:
- Jaw width 100mm
 - Maximum opening 100mm
 - Weight 8Kg

Code	Description	UOM	Price
V33153	4" (100mm) Jaw, Heavy Duty Workshop Vice	EACH	£39.95

Suction Base - 1 1/2" (38mm) Jaw



Mini - Table Top - Suction Vice - Fixed Head

- Vice enables complete flexibility for filing, sawing, soldering, polishing painting models, engraving drilling and grinding
- Small compact fine component holding vice
- No screws move around any ware needed
- The lever-operated suction cup holds tightly and instantly
- Best used on non-porous smooth surfaces such as glass, metal and laminated surfaces such as Formica
- Aluminium jaws fitted for sturdy item holding
- Suction based vice for light work
- Made from light weight plastic with metal components

- Size and weight:
- 85mm x 70mm x 70mm
 - Jaw size 38mm (1 1/2")
 - Maximum opening: 30mm
 - 135g

Code	Description	UOM	Price
V32981	1 1/2" Jaw, Suction Base "Mini" Bench Vice	EACH	£3.50

Suction Base - 2 3/4" (70mm) Jaw

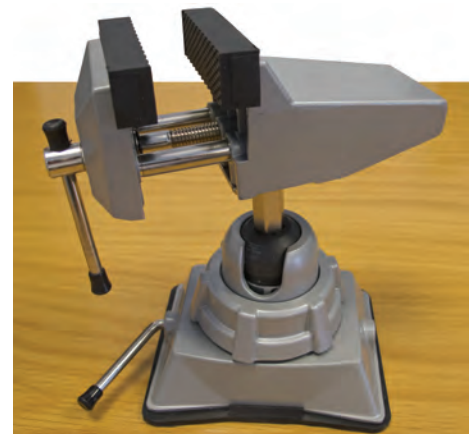

Bench Top - Multi Angle - Suction Base - Model Craft

The ball socket manufacture of this multi-purpose vice enables complete flexibility for filing, sawing, soldering, polishing, painting models, engraving drilling and grinding. Giving you access to the area required all the while holding the item securely with the greatest possible ease

Model Craft vices are for light duty work and should only be used for craft applications

- Jaw Width: 70mm
- Jaw Capacity (without rubber jaws): 70mm
- Jaw Capacity (with rubber jaws): 65mm
- Head Rotation: 360 degrees
- Tilt positions: 0 - 90 degrees
- Suction base ensures the vice is held firmly in position, whilst delivering the ability to re-locate the vice anywhere that it is needed, or simply out of the way!
- The ball sits firmly in the socket whilst allowing the user freedom to reposition work as frequently as required
- The jaws are covered with detachable, protective inserts to avoid damaging the held pieces
- The jaws also have vertical and horizontal V-Grooves ideal for holding rods, wire or circular objects
- Die cast aluminium



- Suction based vice for light work
- Modelcraft range

Dimensions:

- 195 x 130 x 110mm (Height x width x depth)
- Weight: 1.3Kg

Code	Description	UOM	Price
V44333	2 3/4" (70mm) Jaw Suction Base Vice	EACH	£17.95

Vice Jaws - Foredom

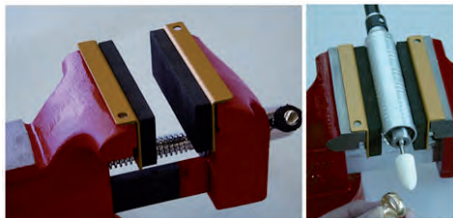

"Soft Jaws" bench vice pads attach to any 3" or 4" Vice with magnetic strips.

- Foredom A-SJ35

They have cushioned pads made of resilient ethylene vinyl acetate that grip odd shapes and prevents marring of polished or painted surfaces and threaded parts.

Code	Description	UOM	Price
FDASJ35	Vinyl Acetate Foredom Soft Jaws	EACH	£8.95

Vice Jaws - Magnetic



Aluminium vice jaws with leather face protectors.

- Protect your work from getting unnecessary, unsightly vice marks
- An inexpensive and vital piece of equipment for any workshop that deals with delicate items in manufacture or repair
- Magnetic backs enabling easy on/off application as well as added strength and stability

Size: 90 x 35mm

Code	Description	UOM	Price
V36090	Vice Jaws, Universal, Leather	PACK*2	£3.75

VICES (HAND-HELD)

A large selection of hand held vices are available. Our range is sourced from all over the world giving our customer excellent choice in price and quality.

Vices have an array of advantages which make the working process a faster and uncomplicated one in filing, tapping, hammering, soldering, forming, polishing, twisting wire/sheet, etc.

10mm Jaw Width, Indian



Hand held, hollow vice for gripping small components e.g. pins, wire, rods etc.

- 10mm Jaw width
- Smooth Jaw
- Length 125mm
- Hole through the centre of the handle to accept long pins and wire
- Maximum jaw opening 3mm
- Steel, knurled handle
- Weight 100g

Code	Description	UOM	Price
V39598	10mm Jaw Width, Indian	EACH	£3.95

12.5mm Jaw Width, Indian



Hand Held Vice for gripping small components e.g. pins, wire, rods etc.

- 12.5mm Jaw Width
- Smooth Jaw
- Length 150mm
- Hole through the centre of the handle to accept long pins and wire
- Maximum Jaw Opening 5mm
- Wooden Handle
- Weight 90gms

Code	Description	UOM	Price
V32161	12.5mm Jaw Width, Indian	EACH	£2.95

15mm Jaw Width with Rotating Handle



Hand vice for holding, bending and twisting your workshop materials

- Handle adjustment rotation jaw open and close action
- For the jeweller, silversmith, arts craft, contemporary jeweller, model makers and light engineers
- Compatible wooden handle
- Quality steel vice jaws and body

150 grams

Code	Description	UOM	Price
V31882	15mm Jaw Width with Rotating Wooden Handle, Indian	EACH	£9.95

25mm Jaw Width, Indian



- 3 inch
- 25mm wide serrated spring loaded jaws
- Opening to max 15mm capacity
- Length 8cm
- Weight 180g

Code	Description	UOM	Price
V9827	25mm Jaw Width, Indian	EACH	£3.30

25mm Jaw Width, Indian



- 6 1/2 inch
 - Length 16.5cm
 - Weight 230g
- 25mm wide smooth spring loaded jaws and central "V" groove, opening to 15mm max capacity and featuring a sealed wooded handle for comfortable grip.

Code	Description	UOM	Price
V9829	25mm Jaw Width, Indian	EACH	£7.90

35mm Jaw Width, Indian



- 4 inch
- 35mm wide serrated spring loaded jaws
- Opening to max 20mm capacity
- Length 10cm
- Weight 260g

Code	Description	UOM	Price
V9828	35mm Jaw Width, Indian	EACH	£4.95



35mm Jaw Width, Brass



- Overall length: 135mm
- 35mm wide, square brass jaws
- Brass jaws for more delicate work, softer metal will not mark your pieces as easily
- With v groove
- Opening to max 45mm capacity
- Knurled handle
- Length 10cm
- Weight 140g

Code	Description	UOM	Price
V39597	35mm Jaw Width, Indian, Brass Jaws	EACH	£6.95

VICES (MACHINE / TOOLMAKERS)

For drilling, light milling, vertical and horizontal work. An excellent range gives you the optimum choice for your workshop. Various levels of gripping power and capacity ensure you will be able to select the machine vice that is right for you.

- Smooth action, durable and precision manufactured
- Cousins, Proxxon & Foredom available

Cousins Machine Vice



- Polished steel jaws
- Incorporates vertical and horizontal v-slots for holding round work pieces
- Jaw width of 45mm and height of 20mm
- 2 x clamping widths, 25 & 15mm
- 120 x 45 x 35mm overall dimensions (L x W x H)
- Steel construction
- Made in E.U

Code	Description	UOM	Price
V49756	Machine Vice, Cousins	EACH	£44.95



SAME DAY DISPATCH



TRADE SUPPLIER

32mm Jaw Width, Zinc Die Cast Vice

FOREDOM®



Foredom A-F37200.

Zinc die cast mini machine vice firmly grasps small workpieces for precision drilling on the table top.

Has horizontal and vertical "V" grooves for holding small round pieces and slots in the base for mounting to drill press table slots. (mounting hardware included).

Exterior dimensions: 4 1/4" Long x 2 3/8" wide x 1 1/2" High.
 Jaw Width: 1 1/4"
 Jaw Capacity: 1 1/2"
 Jaw Height: 1/2"
 Mounting slots 11/64" wide x 1 7/8" long.

Code	Description	UOM	Price
FDAF37200	32mm Jaw Width, Zinc Die Cast Vice	EACH	£20.95

45mm Jaw Width Plastic Vice

FOREDOM®



Foredom A-F37210.

Plastic mini machine vice is great for holding gemstones, shell and other materials that require water during the drilling or shaping process.

Stainless steel threaded shaft for advancing jaw will not rust.

Exterior dimensions: 4 1/4" Long x 3 1/8" wide x 1 3/4" High.
 Jaw Width: 1 3/4"
 Jaw Capacity: 1 5/8"
 Jaw Height: 3/4"
 Mounting holes: 15/64"

Code	Description	UOM	Price
FDAF37210	45mm Jaw Width Plastic Vice	EACH	£14.95



ALL FEEDBACK WELCOME

Proxxon Machine Vice

PROXXON



- Incorporates vertical and horizontal v-slots for holding round work pieces
- Jaw width of 50mm (2") and height of 10mm
- Maximum clamping width of 34mm
- Made special for the TBM 220 drill (Code D9743)
- Specially slotted for the fence on the TBM drill press to facilitate controlled and accurate work

Code	Description	UOM	Price
D9746	50mm Jaw Width Machine Vice	EACH	£12.95

WATCH BEZEL REMOVING & FITTING

Whether your removing "Generic" or "Top Swiss" watch bezels, great tools for making life easier

Watch Bezel Fitting Die Set



Bezel Fitting Die Set - for Rolex & Tudor Watches

- Set of 7 Aluminium Dies with Nylon Inner Ring
- Dies interchangeable with Bergeon crystal presses 5500A & 5500C
- Supplied with 2 adaptors

Code	Description	UOM	Price
B30545	Bezel Fitting Die Set for Rolex & Tudor Watches	PACK*7	£33.50

Watch Bezel Re-Sizing Tool, A*F Swiss



A*F Swiss - Watch Bezel Re-Sizing Tool

Similar to the Rolex 1006 tool, but covers more sizes

This tool is designed for adjusting the size of watch bezels and retaining rings by reducing and enlarging as required.

- Suitable for all bezels
- Particularly suited to Rolex bezels, including the GMT-Masters, Submariners & the large DateJust II model
- The parts are accurately machined from high quality steel
- Finely finished to avoid any damage to the bezel
- The handle is marked with coloured guide marks to judge the degree of resizing
- Supplied in plastic carry case with foam inserts
- A*F Swiss

Set includes:

- 1 End-piece for holding reduction chucks
- 3 Stepped reduction chucks, maximum capacities of each: Ø46, 44 & 42mm
- 1 End-piece for holding enlarging chucks
- 2 Stepped enlarging chucks, maximum capacities of each: Ø43 & 45mm
- 1 Stand for the assembled tool
- 1 Plastic carrying case

Code	Description	UOM	Price
R47011	Bezel Re-Sizing Tool	EACH	£995.00

Watch Bezel Remover, Bergeon 6820

Bezel Remover - Bergeon 6820

Tool for the safe removal of tight rotating watch bezels, diver type on high grade watches (Rolex, Tags, etc.).

Tool provided with 3 adjustable clamping jaws (height 3.5 mm) of hardened and tempered steel, suitable for bezels ranging in Ø from 27 mm to 45 mm.

Automatic jaws locking, position-indexing by spring balls. Bezel clamping by disengageable knurled button.

Supplied with :

- 2 bevelled extraction stakes, Ø 17 and 22 mm
- 2 mm Allen key.

Code	Description	UOM	Price
B0086	Watch Bezel Remover, Bergeon 6820	EACH	£279.95
B6676	Watch Bezel Remover Jaw, Bergeon 6820M	EACH	£34.50
B0086A	Watch Bezel Remover Center Stake, Ø22mm	EACH	£17.75

Watch Bezel Remover, Bergeon 7052



Watch Bezel Removers - Bergeon 7052

- Set of 6 rotating bezel extractors
- Ergonomic handles in anodised aluminium
- Inner ring of synthetic material to prevent scratching or damaging the bezel
- Can remove all types of rotating bezels
- Size of each die is adjustable via a screw to ensure proper grip of the bezel
- 6 sizes: Ø30, 34, 38, 42, 46 & 50mm (inner ring diameter)
- External diameter of the handle Ø80mm

- Bergeon 7052

Size given is the inner ring diameter

Code	Description	UOM	Price
B49724	Bezel Removing Tools, Bergeon 7052	PACK*6	£695.00
B49725	Ø30mm Bezel Remover	EACH	£124.95
B49726	Ø34mm Bezel Remover	EACH	£124.95
B49727	Ø38mm Bezel Remover	EACH	£124.95
B49728	Ø42mm Bezel Remover	EACH	£124.95
B49729	Ø46mm Bezel Remover	EACH	£124.95
B49730	Ø50mm Bezel Remover	EACH	£124.95

Watch Bezel Remover, Bergeon 8820



Bezel Remover - Bergeon 8820

A new ergonomic concept, allowing the extraction of every kind of bezel, from Ø20 to Ø58mm, with great ease. This device offers the possibility of integrating various chucks and tightening jaws, adapted to the majority of bezel shapes.

- Handle made of anodized aluminium.
- Universal chuck in synthetic material with diameter markings
- One set of four movable steel jaws which screw in, giving maximum stability
- Three different diameter centre dies: Ø10, Ø15, Ø20mm

Support Stand:

- Bergeon 8820.0001 (B33547)
- Brings a better stability during operation of extraction

Code	Description	UOM	Price
B33547	Watch Bezel Remover, Bergeon 8820	EACH	£695.00
B35494	Support Stand, Bergeon 8820.S	EACH	£350.00
B52235	Jaw for Bezel Remover	EACH	£60.95

Watch Bezel Remover, Horotec Swiss



Watch Bezel Remover

In hard rubber, for removing rotating watch bezels. Held in the hand to twist and pull off the bezel. Avoids damage to the bezel.

- For bezel diameters 38 to 45mm

- Simple, easy and quick
- Swiss made

Code	Description	UOM	Price
R31399	Watch Bezel Remover, Horotec Swiss	EACH	£16.95

Watch Bezel Remover, Horotec Swiss



Bezel Remover - Horotec Swiss

Tool for the safe removal of tight rotating watch bezels, divers type and for Rolex generics and other generic brands.

- Horotec 07.117
- 4 tempered & polished stainless steel blades
- Precise finish and alignment
- Spare blade available
- Size: 150 x 60 x 65mm
- Weight 880g

Code	Description	UOM	Price
B44237	Bezel Removing Tool, Horotec Swiss	EACH	£205.00
B44245	Blade for Bezel Tool, Horotec Swiss	EACH	£20.95

Watch Bezel Remover (Including Rolex Generics)

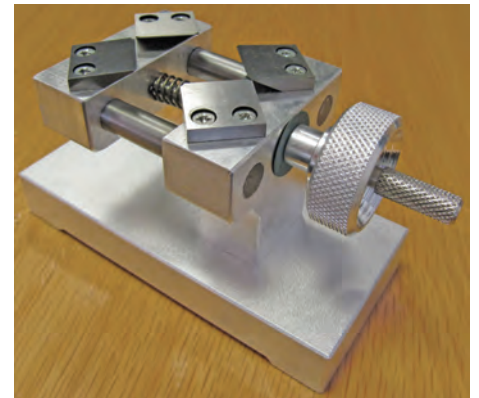

Bezel Remover - Rolex Generics

Tool for the safe removal of tight rotating watch bezels, diver type on and for Rolex generics and other generic brands.

- Size: 130 x 60 x 70mm
- Weight 1500g

Code	Description	UOM	Price
R19381	Bezel Remover for Rolex Generics	EACH	£125.00
R19381J	Bezel Remover Jaw for Rolex Generics	EACH	£11.95

WORLDWIDE DELIVERY

OVER 130,000 DIFFERENT ITEMS

Watch Bezel & Case Back Remover, Horotec



Horotec Swiss - up to Ø45mm

- Can remove bezels and case backs up to Ø45mm
- Tool to open snap on watch case backs or to remove turning bezels
- Can be screwed securely to your work bench (screws not supplied)
- Bezel removing jaws available separately, our code C52364
- Swiss made
- Horotec MSA 07.115

1. The watch is placed upside down on the height's adjustable green rubber sprung loaded support mount.
2. The action can be made by 2 blades placed opposite to each other or by one blade and the white delrin die placed to opposite.
3. The white delrin die has a hole Ø10mm to place the watch crown inside, holding the case steady

Supplied with:

- 2 blades, width 2mm
- 2 blades, width 4mm
- 1 case supporting delrin die
- Pin holder
- Assortment of 11 pins: Ø0.40, 0.60, 0.70, 0.80, 0.90, 1.00, 1.10, 1.20, 1.40, 1.50 & 2.00mm
- Pin to remove blades

Interchangeable Spare Parts:

- C31508 (07.115-A): one blade only width 2mm
- C31509 (07.115-B): one blade only width 4mm
- C31510 (07.115-C): delrin die
- C31511 (07.115-D): pin for removing blades

Code	Description	UOM	Price
C31480	Bezel Removing & Case Opening Tool, Horotec	EACH	£189.50
C31508	2mm Blade, Horotec	EACH	£17.45
C31509	4mm Blade, Horotec	EACH	£15.50
C31510	Delrin Die, Horotec	EACH	£11.95
C31511	Pin for Removing Blades, Horotec	EACH	£1.25
Price breaks available, see website			

Watch Bezel & Case Back Remover, Horotec Extra Large



Horotec Swiss - Extra Large - up to Ø60mm

- Can remove bezels and case backs up to Ø60mm

- Tool to open snap on watch case backs or to remove turning bezels
- Equipped with a screw to stabilise the table at the desired height
- Can be screwed securely to your work bench (screws not supplied)
- Has 4 ridged rubber feet for stability
- Bezel removing jaws available separately, our code C52364
- Swiss made
- Horotec MSA 07.119

1. The watch is placed upside down on the height's adjustable green rubber sprung loaded support mount.
2. The action can be made by 2 blades placed opposite to each other or by one blade and the white delrin die placed to opposite.
3. The white delrin die has a hole Ø10mm to place the watch crown inside, holding the case steady

Supplied with:

- 2 blades, width 2mm
- 2 blades, width 4mm
- 1 case supporting delrin die
- Pin holder
- Assortment of 11 pins: Ø0.40, 0.60, 0.70, 0.80, 0.90, 1.00, 1.10, 1.20, 1.40, 1.50 & 2.00mm
- Pin to remove blades

Interchangeable Spare Parts:

- C31508 (07.115-A): one blade only width 2mm
- C31509 (07.115-B): one blade only width 4mm
- C31510 (07.115-C): delrin die
- C31511 (07.115-D): pin for removing blades

Code	Description	UOM	Price
C45771	Bezel Removing & Case Opening Tool, Extra Large	EACH	£315.00

Bezel Jaws for Bezel & Case Back Remover, Horotec



Horotec Swiss - Bezel Removing Jaws

Adapter for the safe removal of tight rotating watch bezels, divers type and for Rolex generics and other generic brands.

- 4 tempered & polished stainless steel blades
- Precise finish and alignment
- Spare blade available, our code B44245
- Fit directly onto our codes C31480 & C45771
- Perfect for removing bezels delicately
- Maximum opening Ø40mm
- Horotec 07.115.F

Code	Description	UOM	Price
C52364	Bezel Jaws for Bezel & Case Back Remover	EACH	£94.50

Online Discounts

Bezel & Snap On Case Back Remover

See Page 1099



WATCH BRACELET & STRAP ADJUSTING

BRACELET ADJUSTING TOOLS

For the adjustment and removal of bracelet pins and screws. We have a large range and several types of pin removing tools available along with bladed pin tools (screwdriver straight & crosshead ends) accessories for removing screws.

- Straightforward and easy to use, simply choose the correct size pin for your watch bracelet pins and either lightly hammer out, push out or gently screw the pusher pin in to push the bracelet pin out.
- These tools are used for the most common type of bracelet pin you will encounter
- If using free pins, it is best to use a bracelet holding block, see our "bracelet holding blocks" section for a full range

Base, Block & Pins, Bergeon 7744



- Tool to drive out bracelet pins complete with accessories
- With enough space to enable the ejection of the pins
- Ergonomic, professional style

Contents:

- 2 x bracelet holders (B0153)
- Wooden base (B8580)
- 1 pin holder (B0163)
- 6 pins: Ø0.40, 0.60, 0.80, 1.00, 1.50 & 2.00mm (replacements available see code B6686)

Code	Description	UOM	Price
B42020	Bracelet Adjusting Tool, Bergeon 7744	EACH	£54.75

Base, Block & Pins, Cousins Swiss Style



Bracelet Pin Remover - Base, Blocks & Pins - Cousins Swiss Style

- Link pin remover set
- Comprehensive selection of sizes
- Presented and stored on a wooden base
- Stainless steel
- 6 different size pins included

Set includes:

- Pin removing punch
- 6 pins: Ø0.60mm x 2, Ø0.80mm x 2 & Ø1.00mm x 2
- Bracelet holding block x 2
- Wooden base

Code	Description	UOM	Price
B39646	Base, Blocks & Pins Set	EACH	£7.95

Individual, Heavy Duty



Bracelet Pin Removers - Push In

- Push in pin remover
- Excellent for removing rusted or stuck pins
- Length of the removing pin can be set using the guide and stop
- Two different height bracelet tables for different bracelet thicknesses
- Plastic body
- Supplied with 2 pins, Ø1.20 & Ø1.40mm
- 190 x 25 x 30mm (L x W x H)

Code	Description	UOM	Price
B47704	Bracelet Pin Remover, Heavy Duty	EACH	£6.95
B47705	Ø1.20mm Pin	EACH	£0.75
B47733	Ø1.40mm Pin	EACH	£0.75

Individual, Heavy Duty, Adjustable

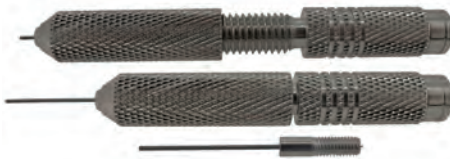

Bracelet Pin Removers - Individual - Heavy Duty - Adjustable

- Shorten the pin, giving it extra strength
- Great for those stubborn bracelet pins
- Ø0.70, 0.80 & 0.90mm available
- Adjust the pin length from 1 to 18mm
- Tool diameter Ø10mm
- Knurled handles
- Spare pins available
- Stainless steel

Code	Description	UOM	Price
B40370	Ø0.70mm Bracelet Pin Tool	EACH	£6.95
B40371	Ø0.70mm Spare Pin	EACH	£0.95
B40372	Ø0.80mm Bracelet Pin Tool	EACH	£6.95
B40373	Ø0.80mm Spare Pin	EACH	£0.95
B40374	Ø0.90mm Bracelet Pin Tool	EACH	£6.95
B40375	Ø0.90mm Spare Pin	EACH	£0.95

Micro Choc, Swiss Style



Bracelet Pin Remover - Micro Choc - Swiss Style

- Supplied with 3 different pulsing force springs
- In Plastic Wallet
- Pin Ø0.80mm

Code	Description	UOM	Price
C30546	Micro Choc Watch Bracelet Pin Remover	EACH	£6.50
C30546A	Pin for Micro Choc	EACH	£1.10

Parallel Action, Bergeon 6578



Bergeon 6578 - Swiss Made

- One side to drive pins in and out
- One side to drive out spring bars
- Metal frame with plastic handles
- Replacement pins/bits available

Code	Description	UOM	Price
B0149	Bracelet Adjusting Tool, Bergeon 6578	EACH	£61.95
B0158	Ø0.70mm Pin	EACH	£3.25
B0159	Ø0.80mm Pin	EACH	£3.25
B0160	Ø0.90mm Pin	EACH	£3.25
B0161	Ø1.20mm Pin	EACH	£3.25
B0161A	Gooved Stake	EACH	£1.75

Punch Kit in Wooden Box



Bracelet Pin Remover - 10 Pins

- Link pin remover set
- Comprehensive selection of sizes
- Presented and stored in a wooden box
- Stainless Steel
- 10 different size pins included (and available separately)

Pin sizes:

- Ø0.40mm, Ø0.60mm, Ø0.70mm, Ø0.80mm
- Ø0.90mm, Ø1.00mm, Ø1.10mm, Ø1.20mm
- Ø1.50mm, Ø2.00mm

Code	Description	UOM	Price
B38403	Bracelet Removing Set	PACK*11	£7.95
B38404	Bracelet Pin Holder	EACH	£0.95
B38405	Ø0.40mm Bracelet Pin	EACH	£0.75
B38406	Ø0.60mm Bracelet Pin	EACH	£0.75
B38407	Ø0.70mm Bracelet Pin	EACH	£0.75
B38408	Ø0.80mm Bracelet Pin	EACH	£0.75

B38409	Ø0.90mm Bracelet Pin	EACH	£0.75
B38410	Ø1.00mm Bracelet Pin	EACH	£0.75
B38411	Ø1.10mm Bracelet Pin	EACH	£0.75
B38412	Ø1.20mm Bracelet Pin	EACH	£0.75
B38413	Ø1.50mm Bracelet Pin	EACH	£0.75
B38414	Ø2.00mm Bracelet Pin	EACH	£0.75

Punch Kit, Swiss Style



Bracelet Pin Remover - 6 Pins - Swiss Style

- Swiss style link pin remover
- Aluminium
- Supplied with 6 pins: Ø0.40, 0.60, 0.80, 1.00, 1.50 & 2.00mm
- Pins also available separately, our reference P37851

Code	Description	UOM	Price
L37834	Bracelet Pin Remover	EACH	£3.75
P37851	Bracelet Pin Remover Pins	PACK*6	£2.25

Punch Kit, Swiss Style & Block

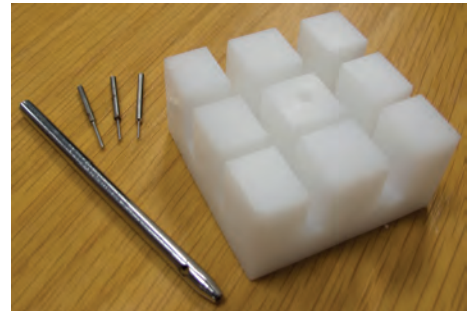

Bracelet Pin Remover - With Block

- High quality bracelet holder made from DELRIN with slots 3, 5, 6 and 8mm
- Link remover (set of 3): Ø0.60, 0.80 & 1.00mm
- Weight: 90g

Code	Description	UOM	Price
B31272	Bracelet Pin Remover with Derlin Bracelet Holder	EACH	£8.95

Punch Set, A*F Swiss

A*F Swiss

Set of 3 in plastic box. Overall length 55mm with handles in chromed brass, diameter 5mm. Tips in hardened steel, working length 15mm. Easily replaced by means of a fixing screw.

- Set of 3: Ø0.70, 0.80 & 1.00mm
- Knurled handles
- Spare pins & grub screws available
- Overall length 55mm
- Working pin length 15mm



Code	Description	UOM	Price
B0144	Bracelet Pin Remover Set	PACK*3	£9.95
B6683	Ø0.70mm Bracelet Pin Remover	EACH	£3.65
B6684	Ø0.80mm Bracelet Pin Remover	EACH	£3.65
B6685	Ø1.00mm Bracelet Pin Remover	EACH	£3.65
B0155	Ø0.70mm Spare Pins	PACK*10	£4.95
B0156	Ø0.80mm Spare Pins	PACK*10	£4.95
B0157	Ø1.00mm Spare Pins	PACK*10	£4.95
B40537	Ø0.70mm Grub Screw	PACK*10	£2.95

Punch Set, Cousins Swiss Style

Bracelet Pin Removers

- Set of 3: Ø0.70, 0.80 & 1.00mm
- Knurled handles
- Stainless steel
- Spare pins available
- Working pin length 15mm
- Overall length 60mm
- Made in India



Code	Description	UOM	Price
B32813	Bracelet Pin Remover Set	PACK*3	£4.50
B32814	Ø0.70mm Spare Pins	PACK*10	£2.95
B32815	Ø0.80mm Spare Pins	PACK*10	£2.95
B32816	Ø1.00mm Spare Pins	PACK*10	£2.95
B40264	Grub Screws for Pin Removers	PACK*10	£0.95

Punch Set, Horotec Swiss



Horotec Swiss

- Pin punch tool with 11 different size pin punches
- Supplied with pin punches: Ø0.40, 0.60, 0.70, 0.80, 0.90, 1.00, 1.10, 1.20, 1.40, 1.50 & 2.00mm
- Anodized brass, knurled handle
- Stainless steel head for extra strength when using a watchmakers hammer
- Supplied in neat plastic storgae case
- For replacement pins please see our codes B41129 to B41134
- Horotec 10.533

Code	Description	UOM	Price
B55899	Bracelet Pin Punch Set, Horotec 10.533	EACH	£19.95
B55901	Handle For Pin Punch Tool	EACH	£12.95

Punch Set (Professional), Bergeon Swiss



Bracelet Pin Removers - Bergeon Swiss - Professional

The highest quality bracelet pin removing punch set available on the market. Ergonomic, comfortable & gets the job done. Made in Switzerland

- Set of 5 pin punches: Ø0.70, 0.80, 0.90, 1.00 & 1.20mm

- Stainless steel handles with knurled rubber coating for easy grip
- Stainless steel pins
- Supplied with 4 sizes of each pin
- Spare pins stored in colour coded tubes
- Punches & tubes are colour coded
- Supplied in black wooden box
- Spare pins & punches available
- Bergeon 6988

Dimensions (approximate):

- Wooden case: 90 x 165 x 30mm (width x length x height)
- Punch (not including pin): Ø6 x 65mm
- Pin length: 20mm

Code	Description	UOM	Price
B52105	Bracelet Pin Punch Set, Bergeon 6988	PACK*5	£114.95
B52106	Punch Ø0.70mm, Bergeon 6988-070	EACH	£18.95
B52107	Punch Ø0.80mm, Bergeon 6988-080	EACH	£18.95
B52108	Punch Ø0.90mm, Bergeon 6988-090	EACH	£18.95
B52109	Punch Ø1.00mm, Bergeon 6988-100	EACH	£18.95
B52110	Punch Ø1.20mm, Bergeon 6988-120	EACH	£18.95
B52111	Pin Ø0.70mm, Bergeon 6988.G.070	EACH	£1.50
B52112	Pin Ø0.80mm, Bergeon 6988.G.080	EACH	£1.50
B52113	Pin Ø0.90mm, Bergeon 6988.G.090	EACH	£1.50
B52114	Pin Ø1.00mm, Bergeon 6988.G.100	EACH	£1.50
B52115	Pin Ø1.20mm, Bergeon 6988.G.120	EACH	£1.50

Price breaks available, see website

Screw In, A*F Swiss



Bracelet Pin Removers - Screw In - A*F Swiss

- A*F Swiss
- In black plastic
- Supplied with spacer for use with three thicknesses of bracelets
- Replaceable pin driver in hardened steel

Code	Description	UOM	Price
B0143	Bracelet Screw In Pin Remover	EACH	£8.50
B0143A	Pin for Bracelet Screw In Pin Remover	EACH	£1.95

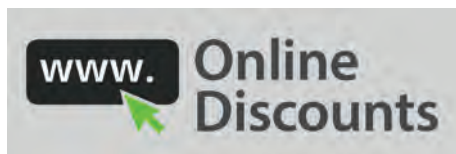

Bracelet Adjusting Kit

See Page 1173



Screw In, Bergeon 7230



Bracelet Pin Removers - Screw In

- Bergeon Swiss
- Ø0.80mm hardened steel pin
- In black plastic
- Supplied with spacer for use with three thicknesses of bracelets

Code	Description	UOM	Price
B47040	Bracelet Pin Remover, Bergeon 7230	EACH	£9.75
B47041	Bracelet Pin, Bergeon 7230-G08	EACH	£1.85

Price breaks available, see website

Screw In, Bergeon 7250



Horizontal, screw in press to drive bracelet pins in and out of watch bracelets with precision. No hammer or vice required.

- Ergonomic design and sleek black look
- Adjustable height bracelet platform
- Extra large, extra grip knurled handle for easy operation & stubborn pins
- Pins are stored in the base for extra space saving
- 4 rubber feet for extra stability on your desk
- Made from lightweight but durable teflon
- Bergeon 7250

Contents:

- 1 Support table with fast height adjustment
- 1 Set of short pins: 2 x Ø0.80 x 27mm long & 2 x Ø1.00 x 27mm long
- 1 Set of long pins: 2 x Ø0.80 x 33mm long & 2 x Ø1.00 x 33mm long

Dimensions:

- Base: 50 x 100mm
- Handle: Ø45mm

Code	Description	UOM	Price
B50924	Bracelet Adjusting Tool, Bergeon 7250	EACH	£275.00
B52040	Ø0.80mm x 27mm Pin	EACH	£1.75
B52041	Ø0.80mm x 33mm Pin	EACH	£1.75
B52042	Ø1.00mm x 27mm Pin	EACH	£1.75
B52043	Ø1.00mm x 33mm Pin	EACH	£1.75

Screw In, Extra Wide



Bracelet Pin Removers - Screw In - Extra Wide

- Durable body and pin holder made in steel
- Easy change watch pin chuck holder
- Includes 4 pin sizes: Ø0.60, 0.90, 1.00 and 1.10mm
- Bracelet height adjustment feature
- Can accommodate bracelets up to 40mm in width

Code	Description	UOM	Price
C36096	Bracelet Screw in Pin Remover, Extra Wide	EACH	£6.95
C36093	Extra Pins for Link remover	PACK*3	£2.95

Screw In, Heavy Duty



Bracelet Pin Removers - Screw In

- Durable body and pin holder made in steel
- Easy change screw in pins
- Includes 2 pins, sizes: Ø0.80 & 1.00mm
- Can accommodate bracelets up to 24mm in width

Code	Description	UOM	Price
B37242	Bracelet Screw in Pin Remover	EACH	£3.50
B37762	Pins for Link Remover	PACK*2	£1.95

Screw In, Seiko Style



Bracelet Pin Removers - Screw In

- Plastic, lightweight body
- Ø0.80mm pin
- With slanted removable base for different thickness bracelets
- Easy change screw in pins
- Large easy to use handle
- Excellent value

Code	Description	UOM	Price
B47060	Bracelet Pin Remover	EACH	£1.95
B47061	Ø0.80mm Pin	EACH	£0.50

Screw In, Seiko S926



Bracelet Adjusting Multi Tool - Seiko S926

Pin remover, screw remover, spring bar remover & bracelet holding block all in one!

This Seiko bracelet sizing tool is designed to make your watch band sizing jobs a whole lot easier. The complete tool for removing all types/sizes of bracelet fixing pins/pipes, screw lugs, bracelet screws and spring bars. Indeed, this excellent and popular tool can be used to size bracelets from most manufacturers. Equipped with bracelet holder, ruler, screwdriver holder, screwdriver, blades and pushing removing bit, presser and removing bits/support bits. All the accessories can be stored within the unit itself under the non-slip rubber base.

- Includes:
- Screwdriver handle
 - 3 removing bits sizes: Ø0.45mm, 0.60mm and 0.80mm
 - 3 pipe install or support bits sizes: Ø0.45mm, 0.60mm and 0.80mm
 - 4 flat head screwdriver blades: 2 x Ø2.50mm and 2 x Ø1.20mm
 - 1 Spring bar removing bit

- Specifications:
- Used to size bands with: push pins, clip springs, free pins and c-ring pipes, screws, fixing pins and spring bars
 - 3 slots in different sizes for holding watch bands
 - Ruler measures up to 30mm
 - Non-slip rubber base
 - 95 x 90 x 30mm
 - Made in Japan by Seiko

Code	Description	UOM	Price
B52198	Bracelet Adjusting Multi Tool, Seiko S-926	EACH	£64.95
B52199	Pin Set for Seiko Tool	PACK*6	£13.50
B52200	Blade Set for Seiko Tool	PACK*4	£12.95
B52201	Bracelet Fixing Attachment	EACH	£4.95

BRACELET ADJUSTING TOOLS WITH STAND



For the adjustment and removal of bracelet pins and screws. We have a large range and several types of pin removing tools available along with bladed pin tools (screwdriver straight & crosshead ends) accessories for removing screws.

These are the original Swiss made Bergeon & Horotec tools along with good value Swiss style alternatives bought to you by

Cousins. Take a look at the various versions, all designed to remove watch bracelet pins and links, and choose one you are most comfortable with.

- When used correctly, there is pretty much zero chance of scratching a watch bracelet with these precision made tools
- Highest grade steel is used achieving ultimate quality and high precision tools

A*F Swiss Screw Removing for Gucci



A*F Swiss

A new tool, Swiss made, perfect for removing bracelet screws from Gucci and other high fashion watches.

- Body made from hard black plastic
- Blades recessed in nylon to avoid scratching
- Plastic collars can be filed as required
- Supplied with two spare blades
- Spare compartment to store spare blades and parts
- Ø3mm blade
- Can also be used for case screws

Code	Description	UOM	Price
B40266	Bracelet Screw Removing Tool	EACH	£55.95
B40267	Blade for Bracelet Screw Removing Tool	EACH	£5.95

Bergeon 7260



Device for un/screwing bracelet screws

- Delrin Construction
- Table with height adjustment screw
- Replaceable socket for the use of various screwdriver diameters
- Screwdriver locking screw
- Stable base with anti-slip pads
- Bergeon Swiss
- 7260

Code	Description	UOM	Price
B56483	Bracelet Tool, Bergeon 7260	EACH	£259.95

PRICE PROMISE GUARANTEE ✓

Bergeon 7745 (reduced set)



Press to drive bracelet pins in and out of watch bracelets.

Reduced version of 7745.100 (B38740).

Contents:

- 1 Stand
- 1 bracelet holding block (B0153)
- 1 pin holder (B0163)
- 1 set of 6 pins on wooden stand: Ø0.40, 0.60, 0.80, 1.00, 1.50 & 2.00mm (replacements available see code B6686)

Code	Description	UOM	Price
B38739	Bracelet Adjusting Tool, Bergeon 7745	EACH	£149.95

Bergeon 7745.100



To drive pins in and out and remove screwed links.

- The bracelet block allows accurate positioning for watches with leather or metal bracelets.
- The two bases are height adjustable to align the job in exactly the right place

Contents:

- 1 Stand
- 1 pin holder with drum (B0163A)
- 2 bases with adjustable heights (B8682 & B8683)
- 1 bracelet holder (B0153)
- 1 set of ten blades on wooden stand (B6682B)
- 1 set of 6 pins on wooden stand: Ø0.40, 0.60, 0.80, 1.00, 1.50 & 2.00mm (replacements available see code B6686)
- 1 mirror disc

Code	Description	UOM	Price
B38740	Bracelet Adjusting Tool, Bergeon 7745-100	EACH	£184.95

Watchmakers Hammers

See Page 807



Bergeon 8745, Ergonomic



Press to drive bracelet pins in and out of watch bracelets. & unscrew and screw watch bracelets.

Ergonomic design and sleek black look.

Contents:

- 1 Support
- 1 Pin holder with drum (B0163A)
- 2 Bases with adjustable heights (B8682 & B8683)
- 1 Set of 10 blades (B6682B)
- 1 Set of 6 pins: Ø0.40, 0.60, 0.80, 1.00, 1.50 & 2.00mm (replacements available see code B6686)
- Pins, blades & bases all handily stored in base of tool
- Bracelet block code B0153 (not included)

Code	Description	UOM	Price
B38741	Bracelet Adjusting Tool, Bergeon 8745	EACH	£130.95

Bergeon 7745.ASS, Accessories



Code	Description	UOM	Price
B0152	Accessory Set Complete, Bergeon 7745.ASS	EACH	£64.95
B42021	Base, Bergeon 7744-S	EACH	£16.95
B8682	Base Ø20mm, Bergeon 6745-SR20	EACH	£11.75
B8683	Base Ø28mm, Bergeon 6745-SR28	EACH	£12.75
B6687	Blade Ø0.80mm Straight, Bergeon 6745-MC	EACH	£2.75
B6687A	Blade Ø1.00mm Straight, Bergeon 6745-MC	EACH	£2.75
B6687B	Blade Ø1.20mm Straight, Bergeon 6745-MC	EACH	£2.75
B6682	Blade Ø1.50mm Cross head, Bergeon 6745-MC	EACH	£2.75
B6688C	Blade Ø1.50mm Straight, Bergeon 6745-MC	EACH	£2.75
B6682A	Blade Ø2.00mm Cross head, Bergeon 6745-MC	EACH	£2.75
B6688D	Blade Ø2.00mm Straight, Bergeon 6745-MC	EACH	£2.75
B6682B	Blade Set, Bergeon 7745-MS	EACH	£27.65
B49253	Bracelet Holding Block, Bergeon 8744	EACH	£69.95
B8663	Cracked Base Chuck, Bergeon 6745-DF	EACH	£6.95
B47706	Mirror Disc, Bergeon 7745-P	EACH	£18.95
B6686	Pin Ø0.40mm, Bergeon 6745-G	EACH	£1.45
B2060	Pin Ø0.60mm, Bergeon 6745-G	EACH	£1.45
B32752	Pin Ø0.70mm, Bergeon 6745-G	EACH	£1.45
B2061	Pin Ø0.80mm, Bergeon 6745-G	EACH	£1.45
B32753	Pin Ø0.90mm, Bergeon 6745-G	EACH	£1.45
B2062	Pin Ø1.00mm, Bergeon 6745-G	EACH	£1.45

B52884	Pin Ø1.20mm, Bergeon 6745-G	EACH	£1.45
B2063	Pin Ø1.50mm, Bergeon 6745-G	EACH	£1.45
B2064	Pin Ø2.00mm, Bergeon 6745-G	EACH	£1.45
B0162	Pin Holder, Bergeon 6744-PG	EACH	£11.85
B0163	Pin Holder, Bergeon 6745-PG	EACH	£10.95
B0163A	Pin Holder With Drum, Bergeon 7745-PG-A	EACH	£14.95

Cousins, Swiss Style



Bracelet pin and screw removing kit

Kit contains:

- 12 pins, two each of: Ø0.40, 0.60, 0.80, 1.00, 1.50 & 2.00mm
- Pin holder with knurled handle
- Two screwdriver blades: Ø1.50 & 2.50mm
- Screwdriver blade holder with knurled handle
- Screw holding base with Ø2.50mm blade
- Bracelet holding block
- 90 x 60 x 80mm (H x W x D)
- Made in far east

What amazing value!

Code	Description	UOM	Price
B39645	Bracelet Pin Tool Kit	EACH	£17.95
B41167	Blade Set with Stand	PACK*10	£4.95
B41168	Pin Set with Stand	PACK*6	£4.95

Horotec Swiss 10.499 (reduced set)



Horotec Swiss 10.499 (reduced set) - Bracelet Pin Adjusting Tool

Press for rapidly assembling and disassembling bracelet pins. All accessories easily accessible and stored on the top plate. The vertical guide allows perfect alignment with the bracelet pins.

Kit contains:

- 1 Press
- 6 pins: Ø0.40, 0.60, 0.80, 1.00, 1.50 & 2.00mm, stored on top plate
- Pin holder
- Bracelet holding block
- Horotec 10.499

For spare pins and accessories see code B41129

Code	Description	UOM	Price
B41128	Bracelet Pin Tool Kit, Horotec Swiss	EACH	£79.95

Horotec Swiss 10.500



Horotec Swiss 10.500 - Bracelet Pin Adjusting Tool

Press for rapidly assembling and disassembling bracelet pins and screws. All accessories easily accessible and stored on the top plate. The vertical guide allows perfect alignment with the bracelet screws & pins.

Kit contains:

- 1 Press
- 11 pins: Ø0.40, 0.60, .0.70, 0.80, 0.90, 1.00, 1.10, 1.20, 1.40, 1.50 & 2.00mm, stored on top plate
- 12 blades, 2 each of sizes: Ø0.80, 1.00, 1.20, 1.40, 1.60 & 2.00mm
- Pin holder
- Knurled handle for blades
- Bracelet holding block & support
- Counter screw blade holder
- Delrin conical bracelet protection
- Horotec 10.500

Code	Description	UOM	Price
B43274	Bracelet Pin Tool Kit, Horotec Swiss	EACH	£124.95
B43276	Conical Delrin Bracelet Protection	EACH	£9.95
B43278	Counter Screw Blade Holder	EACH	£29.95
B43277	Knurled Handle	EACH	£25.95
B43275	Pin Holder	EACH	£16.75
B41129	Ø0.40mm Pin	EACH	£1.60
B41130	Ø0.60mm Pin	EACH	£1.60
B41131	Ø0.80mm Pin	EACH	£1.60
B41132	Ø1.00mm Pin	EACH	£1.60
B41133	Ø1.50mm Pin	EACH	£1.60
B41134	Ø2.00mm Pin	EACH	£1.45

Price breaks available, see website



Protection Film for Watch Bracelets

See Page 1281

BRACELET ADJUSTING PLIERS



Excellent range of pliers specifically for the quick adjustment of your customers' watch bracelets.

- Adjust your watch band and avoid damage with these watch link removing pliers
- These unique devices are perfect for removing stubborn watch bracelet pins
- Remove slide type links with ease with our specially manufactured "pull out" link pliers
- Our spring loaded multi pin tools are designed so that the "punch pin" will move perfectly parallel, ensuring a damageless removal of the pin if used properly

Link Removing Pliers

VALUE

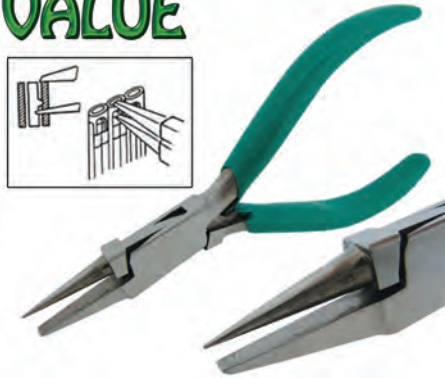
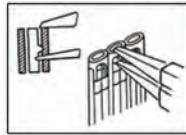

Bracelet Link Removing Pliers

- An essential tool for adjusting the length of metal watch bracelets
- Lap joint with one flat and one extended round jaw

Code	Description	UOM	Price
B35025	Bracelet Link Removing Pliers	EACH	£3.95

Link Removing Pliers, A*F Swiss

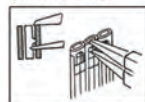

Bracelet Link Removing Pliers - A*F Swiss

- An essential tool for adjusting the length of metal watch bracelets
- In polished steel, lap joint with one flat and one extended round jaw
- A top quality version of this popular tool
- Handles covered in blue plastic with leaf springs

Code	Description	UOM	Price
B0145	Bracelet Link Removing Pliers	EACH	£17.75

Link Removing Pliers, Cousins Swiss Style



Bracelet Link Removing Pliers - Cousins Swiss Style

- An essential tool for adjusting the length of metal watch bracelets
- One flat and one extended round jaw (Ø1mm)
- In polished steel, lap joint
- A top quality version of this popular tool
- Blue plastic handles
- Spring loaded (double leaf springs)
- Length 130mm
- Cousins Swiss Style
- Superb Swiss quality pliers

Code	Description	UOM	Price
P50536	Bracelet Link Removing Pliers	EACH	£9.95

Link Removing Pliers, Cousins Swiss Style



Bracelet Link Removing Pliers - Cousins Swiss Style

- An essential tool for adjusting the length of metal watch bracelets
- One flat jaw with cut out and one rounded jaw
- In polished steel, lap joint
- A top quality version of this popular tool
- Blue plastic handles
- Spring loaded (double leaf springs)
- Length 130mm
- Cousins Swiss Style
- Superb Swiss quality pliers

Code	Description	UOM	Price
P55838	Bracelet Link Removing Pliers, Cousins Swiss Style	EACH	£7.95

Link Removing Pliers, Horotec Swiss



Bracelet Link Removing Pliers - Horotec Swiss

- An essential tool for adjusting the length of metal watch bracelets
- One flat jaw with cut out and one rounded jaw
- In polished steel, lap joint
- A top quality version of this popular tool
- Plastic handles
- Length 130mm
- Horotec 11.812

Code	Description	UOM	Price
P55839	Bracelet Link Removing Pliers, Horotec Swiss	EACH	£11.95

Pin Removing Pliers, Bergeon



Bracelet Pin Removing Pliers - Multi Pin - Bergeon Swiss

This sturdy plier is an effective tool used for inserting, removing and reinserting pins for all types of metal bands / watch bracelets. Its plastic support prevents damage to the band during handling.

Using the set of shims provided as standard accessories, you can adjust the pliers to the size of the band. The integral protective supports and the shims position the job correctly and the tool has an overall feel of renowned Bergeon quality.

- Up to 24mm Width
- Rapid and easy removal of pinned watch bracelet links
- Ø0.75 & 0.85mm pin plungers
- Includes full and illustrated instructions
- Bergeon 6819

Code	Description	UOM	Price
B9239	Pin Removing Pliers, Bergeon	EACH	£149.95
B9239A	Ø0.75mm Pin	EACH	£10.85
B9239B	Ø0.85mm Pin	EACH	£10.85
B9239C	Ø0.75mm Pin, Spring & Body	EACH	£16.85
B9239D	Ø0.85mm Pin, Spring & Body	EACH	£16.85

Pin Removing Pliers, Cousins



Bracelet Pin Removing Pliers - Multi Pin - Cousins

- Up to 24mm Width
- Rapid and easy removal of pinned watch bracelet links
- Supplied with pouch and 0.80 & 1.00mm pin pusher
- Spare pins, Cousins Item: B12166, B12167 & B8786

Code	Description	UOM	Price
B8785	Pin Removing Pliers, Cousins	EACH	£11.50
B12166	Ø0.70mm Replacement Pin	EACH	£1.45
B12167	Ø0.80mm Replacement Pin	EACH	£1.45
B8786	Ø1.00mm Replacement Pin	EACH	£1.45

Pin Removing Pliers, Cousins, Wide Bracelets



Bracelet Pin Removing Pliers - Multi Pin - Cousins - Extra Wide

- Up to 40mm Width
- Rapid and easy removal of pinned links from larger watch bracelets
- Supplied with pouch and 0.80 & 1.00mm pin pusher
- Spare pins, Cousins Item: B12166, B12167 & B8786

Code	Description	UOM	Price
B20208	Pin Removing Pliers, Cousins, Wide Bracelets	EACH	£11.95

BRACELET ADJUSTING FOR ROLEX BRACELETS

Integrated Link Fitting Tool



Integrated Bracelet Link Fitting Tool

- Helps to fit bracelets with integrated links efficiently and with accuracy
- Fit the link to the bracelet, then use the tool to fix the link in place with precision
- Turn the handle to close the vice and fit the link
- High quality
- Stainless steel
- Rolex style bracelet link fitting tool
- See video demonstration link

Code	Description	UOM	Price
B50363	Integrated Link Fitting Tool	EACH	£259.95

Bracelet Link (Oyster Style) Removing Tool



Integrated Bracelet Link Removing Tool

- Helps to remove links from integrated bracelets
- High quality
- Stainless steel
- Rolex Oyster style bracelet link removing tool
- See video demonstration link

Code	Description	UOM	Price
B50364	Integrated Bracelet Link Removing Tool	EACH	£325.00

Threaded Top or Bottom Watch Bracelet Screws

See Page 650



Rolex Style Knurled Pins

See Page 188



WORLDWIDE DELIVERY



IMPROVED SPEED SEARCH

Bracelet Link (Jubilee Style) Removing Tool



Integrated Bracelet Link Removing Tool

- Helps to remove links from integrated bracelets
- High quality
- Stainless steel
- Rolex Jubilee style bracelet link removing tool
- 6 dies included (also available separately)
- See video demonstration link

Code	Description	UOM	Price
B50365	Integrated Bracelet Link Removing Tool	EACH	£295.00
B52945	Die Set for Bracelet Link Removing Tool	PACK*6	£89.95

BRACELET SCREW REMOVING THIRD HAND

Screw Holding Bases

Bracelet Screw Holding Bases

Save time with these handy tools which simplify the removal and fitting of metal watch bracelet links, screw type case bars or any general watch screws.

- Used to remove double-ended screws from a watch bracelet
- Just fit the bottom screw slot over the right blade ensuring an easy unscrewing from the top
- Makes life simple and assures that the bracelet will not be damaged, if used properly

A*F Swiss, Screw Holding Base

A*F Swiss 189.895

- Save time with this handy tool which simplifies removal and fitting of metal watch bracelet links and screw type case bars
- Features three replaceable, popular size blades Ø1.00, 1.40, 3.00mm mounted on a non-slip, aluminium stand



Replacement Blade item codes:

- Ø1.00mm = S2941
- Ø1.40mm = S2943
- Ø3.00mm = S2947

Code	Description	UOM	Price
B0146	A*F Swiss, Screw Holding Base	EACH	£17.50

Bergeon Swiss, Screw Holding Base



Bergeon 6730

- In brass, base Ø70mm
- 4 screwdriver blades Ø1.00, 1.40, 1.80 and 3.00mm
- Working blade with adjustable height
- Removable rubber protection on top
- Very stable

Code	Description	UOM	Price
B0147	Bergeon Swiss, Screw Holding Base	EACH	£82.95

Horotec Swiss, Screw Holding Base



Horotec 10.520

- In stainless steel
- 3 screwdriver blades Ø1.00, 1.40 and 3.00mm
- Anti skid base
- Very stable
- Ø25mm

Code	Description	UOM	Price
B49332	Horotec Swiss, Screw Holding Base	EACH	£13.85

Indian, Screw Holding Base



- Three blades (Ø1.00, 1.40, 2.50mm) are immovably fitted to a solid aluminium block
- Used to remove double-ended screws from a watch bracelet
- Just fit the bottom screw slot over the right blade ensuring an easy unscrewing from the top
- Makes life simple and assures that the bracelet will not be damaged, if used properly

Code	Description	UOM	Price
S36098	Indian, Screw Holding Base	EACH	£4.50

TODAY SAME DAY DISPATCH

PRICE PROMISE GUARANTEE

BRACELET BLOCKS

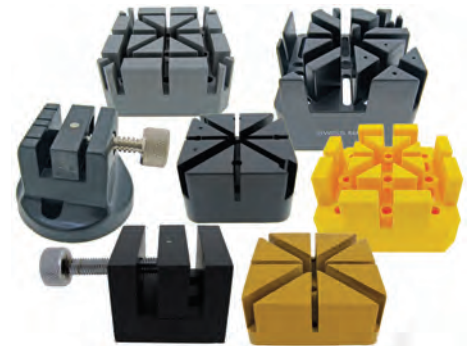

Large range of watch band holders available including plastic, flexi-plastic and wooden; we have a large range of holders that will not damage your bracelets.

- The bracelets are held in the slots of the holding block, rendering it easy to use a pin punch and hammer to remove band links and pins when sizing a watch bracelet
- Watch bracelet holders are made of a strong and rigid synthetic material that will not mar or scratch watch bands
- Our bracelet screw holding bases are designed perfectly for removing the double ended screw bracelet pin type

Holding Vice

8 x 14mm Capacity Bracelet Holder, A*F Swiss



- A*F Swiss
- Ideal for after-sales service
- Hard plastic vice which does not damage soft metals such as gold
- Can hold any type of bracelet

Code	Description	UOM	Price
B12394	8 x 14mm Capacity Bracelet Holder, A*F Swiss	EACH	£23.95

9.5 x 12mm Capacity Bracelet Holder, Horotec Swiss



- Max bracelet thickness 9.5mm
- Bracelet holding height 12mm
- 55 x 35 x 22mm
- Horotec 10.513

Code	Description	UOM	Price
B44243	9.5 x 12mm Capacity Bracelet Holder, Horotec Swiss	EACH	£16.75

10 x 10mm Capacity Bracelet Holder



- Max bracelet thickness 10mm
- Bracelet holding height 10mm
- 37 x 34 x 31mm
- White plastic

Code	Description	UOM	Price
B37143	10 x 10mm Capacity Bracelet Holder	EACH	£5.50

10 x 49mm Capacity Bracelet Holder, Horotec Swiss

- Max bracelet thickness 10mm
- Bracelet holding height 49mm
- 55 x 35 x 22mm
- Horotec 10.519



Code	Description	UOM	Price
B44244	10 x 49mm Capacity Bracelet Holder, Horotec Swiss	EACH	£26.95

15 x 12mm Capacity Bracelet Holder

- Max bracelet thickness 15mm
- Bracelet holding height 12mm
- 55 x 35 x 20mm
- Black plastic



Code	Description	UOM	Price
B38765	15 x 12mm Capacity Bracelet Holder	EACH	£6.95

24 x 17mm Capacity Bracelet Holder

- Max bracelet thickness 17mm
- Bracelet holding height 24mm
- 50 x 40 x 40mm
- Black plastic



Code	Description	UOM	Price
B38766	24 x 17mm Capacity Bracelet Holder	EACH	£8.95

Holding Blocks

Standard Slots (with 4 Pin Holders)

- Non Swiss
- Size: 50 x 50mm



Code	Description	UOM	Price
B36097	Standard Slots (with 4 Pin Holders)	EACH	£1.95

Standard Slots, Wooden

- Non Swiss
- Size: 60 x 60mm



Code	Description	UOM	Price
B36466	Standard Slots, Wooden	EACH	£1.95

Standard & Wide Slots

- Non Swiss
- Size: 50 x 50mm



Code	Description	UOM	Price
B36468	Standard & Wide Slots	EACH	£1.25

Standard & Wide Slots (with 4 Pin Holders)

Features holes on sides for holding pin punches.

- Non Swiss
- Size: 65 x 65 x 25mm
- Standard & wide slots
- Plastic



Code	Description	UOM	Price
B44368	Standard & Wide Slots (with 4 Pin Holders)	EACH	£1.95

Standard & Wide Slots XL, Plastic

- With slots 3 to 10mm wide
- Extra large base catering for extra long bracelets
- 80 x 80 x 30mm



Code	Description	UOM	Price
B45546	Standard & Wide Slots XL, Plastic	EACH	£2.25

Standard & Wide Slots, XL - Wooden

- With slots 3 to 7mm wide
- Extra large base catering for extra long bracelets
- 80 x 80 x 30mm



Code	Description	UOM	Price
B43267	Standard & Wide Slots, XL - Wooden	EACH	£3.50

Holding Blocks, Swiss

A*F Swiss, Ø50mm

- Swiss Made
- Round base
- Ø50mm
- Mixture of standard & wide slots
- A*F Swiss



Code	Description	UOM	Price
B40265	A*F Swiss, Ø50mm	EACH	£21.95

A*F Swiss, 50 x 50mm

A*F Swiss

Model in hard black plastic with wider slots for larger bracelets. Cut-out in one corner for watch case horns.



Code	Description	UOM	Price
B0154	A*F Swiss, 50 x 50mm	EACH	£13.65

PRICE PROMISE
GUARANTEE



A*F Swiss, 55 x 55mm

A*F Swiss

Best quality model in hard black plastic with various widths of slots.

- Swiss Made
- Size: 50 x 50 x 40 mm
- Wide slots for thicker bracelets



Code	Description	UOM	Price
B4193	A*F Swiss, 55 x 55mm	EACH	£9.95

Bergeon 6744P, 53 x 53mm

- Swiss Made
- Bergeon 6744.P
- Sizes: 53 x 53 x 26mm
- Slots Sizes: 2.2, 2.6, 3.0, 3.4, 3.8 & 4.0mm



Code	Description	UOM	Price
B0153	Bergeon 6744P, 53 x 53mm	EACH	£6.25

Bergeon 6744.P.S, 53 x 53mm (Soft Flexi Base)

- Swiss Made
- Bergeon 6744.P.S
- In "soft" synthetic material
- Sizes: 53 x 53 x 26mm
- Slots Sizes: 2.2, 2.6, 3.0, 3.4, 3.8 & 4.0mm



Code	Description	UOM	Price
B15209	Bergeon 6744.P.S, 53 x 53mm (Soft Flexi Base)	EACH	£7.75

Bergeon 6744.P1 53 x 53mm

Wide slots for thicker bracelets

- Swiss Made
- Bergeon 6744.P
- Sizes: 53 x 53 x 26mm
- Slots Sizes: 3.5, 4.0, 4.5, 5.0, 5.5, 6.0, 6.5 & 7.0mm



Code	Description	UOM	Price
B8593	Bergeon 6744.P1 53 x 53mm	EACH	£7.95

Bergeon 6744.P1.S, 53 x 53mm (Soft Flexi Base)

Wide slots for thicker bracelets

- Swiss Made
- Bergeon 6744.P1.S
- In "soft" synthetic material
- Especially made for all precious metals, without any risk of scratching
- Sizes: 53 x 53 x 26mm
- Slots Sizes: 3.5, 4.0, 4.5, 5.0, 5.5, 6.0, 6.5 & 7.0mm



Code	Description	UOM	Price
B18337	Bergeon 6744.P1.S, 53 x 53mm (Soft Flexi Base)	EACH	£9.50

www. Online Discounts

Horotec Swiss, 52 x 52mm Universal



- Horotec Swiss Made
- Mixture of standard & wide slots
- Size: 52 x 52 x 25mm
- Slot Sizes: 2.8 to 6.3mm

Code	Description	UOM	Price
B4710	Horotec Swiss, 52 x 52mm Universal	EACH	£3.95

BRACELET CLASP SAVER TOOL

Bracelet Clasp Saver Tool



A*F 189.835 - Swiss Made

Watchmakers adjustment tool for folding clasps on watch bracelets. No more need to throw away or replace folding or butterfly clasps that no longer lock with this clasp saving tool!

- Saves folding clasps by allowing them to "click" and lock again
- Clasps which were previously impossible to fix or repair can now be saved
- Prevents expensive bracelet purchases
- Works by carefully & precisely adjusting the thick metal middle sections found on most folding clasps
- Instructions included
- Swiss made

Die dimensions;

- Push Dies = widest working width
- U Dies = outside width

Code	Description	UOM	Price
B38846	Bracelet Clasp Saver, A*F 189.835	EACH	£109.95
C48011	Push Die (8mm) Curve	EACH	£9.95
C48012	Push Die (8mm) Point	EACH	£9.95
C48013	Push Die (18mm) Curve	EACH	£9.95
C48014	U Die (14mm)	EACH	£9.95
C48015	U Die (20mm)	EACH	£9.95
C48016	U Die (22mm)	EACH	£9.95

TODAY SAME DAY DISPATCH



BRACELET CUTTING, FILING & SHORTENING

- Most popular tooling for adjusting a watch bracelet quickly and efficiently
- This Bergeon Swiss traditional bracelet cutting machine is one of the highest end units available for precision cutting and sizing of your watch bracelets
- Traditional filing blocks are also available

Bracelet Cutting Machine



- Bergeon 5683
- The cutting length is regulated by a pair of mobile stops
- Cutting is effected within a few seconds automatically on the left and right, to the corresponding dimensions
- Switch for starting
- Dimensions: 180 x 125 x 125 mm
- Max. cutting width 30 mm
- Wheel Ø 65 mm
- Instructions included

Code	Description	UOM	Price
B0142	Bracelet Cutting Machine, Bergeon 5683	EACH	£725.00
B0140	Cutting Wheel, Bergeon 5544-C	EACH	£4.45
B22683	Motor, Bergeon 5683-MA-220	EACH	£950.00

Price breaks available, see website

Bracelet Filing Blocks

- Held in vice.
- Ensures a quick and easy method of filing the ends of bracelets for the band that requires a small adjustment to be made.
- Will take most sizes of bracelets (12 grooves).



Code	Description	UOM	Price
B7989	Bracelet Filing Block, Cousins	EACH	£3.25
B0141	Bracelet Filing Block, Bergeon Swiss	EACH	£29.95

ONLINE QUOTES

ORDER tracking

SPRING BAR CURVING TOOLS

Spring Bar Curving Pliers

VALUE



Spring Bar Curving - Pliers

- Easily curve spring bars
- Pressure exerted through pliers
- Overall length 135mm
- Made in India

Code	Description	UOM	Price
P37634	Spring Bar Pliers	EACH	£4.25

Spring Bar Curving Tool, Horotec Swiss



Spring Bar Curving - Horotec Swiss

The Horotec spring bar curving tool allows you to bend even the thickest of spring bars with ease.

- 110mm long lever allows greater force to be applied with smaller pressure
- 2 different bending chambers (small and large), so the bend is proportionate to the spring bar length
- Appropriate size chambers greatly reduces the risk of damaging the spring bar
- Can be screwed to bench (screws not included)
- Horotec 10.311

Dimensions:

- 130 x 30 x 80mm
- 120g

Code	Description	UOM	Price
S44236	Spring Bar Curving Tool, Horotec Swiss	EACH	£74.95

ONLINE ORDER STATUS

SPRING BAR REMOVING TOOLS

Bergeon Bakelite, Hexagonal (3153)



- Ø0.80mm pin (L0937)
- 3mm wide fork (L0936)
- Hexagonal black bakelite handle
- Graduated in mm for measuring distance between lugs
- Length: 148mm

Code	Description	UOM	Price
L0935	Spring Bar Tool, Bergeon 3153	EACH	£11.75
L0936	Fork End, Bergeon 3153A	EACH	£2.10
L0937	Pin End, Bergeon 3153B	EACH	£0.65

Price breaks available, see website

Bergeon 6111 Chuck Grip



- Tool with reversible point/fork and spatula-shaped fork
- Ends held via a chuck
- Pin, fork & angled fork
- Nickel plated
- Knurled handle
- Length: 140mm
- Bergeon 6111

Replacement ends:

- Ø0.80mm pin & 1mm fork reversible end = L0939A
- 4mm wide angled fork = L0939B

Code	Description	UOM	Price
L0938	Bergeon 6111, Chuck Grip	EACH	£24.50
L0939A	Pin & Fork End, Bergeon 6111 & 8111	EACH	£3.45
L0939B	Fork End, Bergeon 6111 & 8111	EACH	£3.50

Price breaks available, see website

Bergeon 8111 Chuck Grip



- Tool with reversible point/fork and spatula-shaped fork
- Ends held via a chuck
- Pin, fork & angled fork
- Nickel plated
- Special profile, extra knurled handle
- Length: 140mm
- Bergeon 8111

Replacement ends:

- Ø0.80mm pin & 1mm fork reversible end = L0939A
- 4mm wide angled fork = L0939B

Code	Description	UOM	Price
S49254	Bergeon 8111, Chuck Grip, Extra Knurled	EACH	£21.95
L0939A	Pin & Fork End, Bergeon 6111 & 8111	EACH	£3.45
L0939B	Fork End, Bergeon 6111 & 8111	EACH	£3.50

Price breaks available, see website

Bergeon 6767F Screw In, Fine



- Tool with fine ends
- Ø0.80mm pin (L0942)
- 1mm wide fork (L0941)
- Handle in polished nickel plated brass
- Knurled handle
- Points in hardened tempering steel
- Length: 145mm
- Bergeon 6767F

Replacement ends:

- Ø0.80mm pin = L0942
- 1mm wide fork = L0941

Code	Description	UOM	Price
L0940	Bergeon 6767F, Fine Ends	EACH	£8.75
L0941	Fork End (Fine) Bergeon 6767F & 7767F	EACH	£1.85
L0942	Pin End (Fine) Bergeon 6767F & 7767F	EACH	£0.99

Price breaks available, see website

Bergeon 6767S Screw In, Standard



- Tool with standard ends
- Ø0.80mm pin (L0945)
- 3mm wide fork (L0944)
- Handle in polished nickel plated brass
- Points in hardened tempering steel
- Knurled handle
- Length: 145mm
- Bergeon 6767S

Replacement ends:

- Ø0.80mm pin = L0945
- 3mm wide fork = L0944

Code	Description	UOM	Price
L0943	Bergeon 6767S, Standard Ends	EACH	£8.75
L0944	Fork End (Standard) Bergeon 6767S & 7767S	EACH	£1.75
L0945	Pin End (Standard) Bergeon 6767S & 7767S	EACH	£1.05

Price breaks available, see website

Bergeon 7767F Screw In, Fine



- Tool with fine ends
- Ø0.80mm pin (L0942)
- 1mm wide fork (L0941)
- Handle in polished nickel plated brass
- Special profile, extra knurled handle
- Points in hardened tempering steel
- Length: 145mm
- Bergeon 7767F

Replacement ends:

- Ø0.80mm pin = L0942
- 1mm wide fork = L0941

Code	Description	UOM	Price
S49255	Bergeon 7767F, Fine Ends, Extra Knurled	EACH	£10.50
L0941	Fork End (Fine) Bergeon 6767F & 7767F	EACH	£1.85
L0942	Pin End (Fine) Bergeon 6767F & 7767F	EACH	£0.99

Price breaks available, see website

Bergeon 7767S Screw In, Standard



- Tool with standard ends
- Ø0.80mm pin (L0945)
- 3mm wide fork (L0944)
- Handle in polished nickel plated brass
- Points in hardened tempering steel
- Special profile, extra knurled handle
- Length: 145mm
- Bergeon 7767S

Replacement ends:

- Ø0.80mm pin = L0945
- 3mm wide fork = L0944

Code	Description	UOM	Price
S49256	Bergeon 7767S, Standard Ends, Extra Knurled	EACH	£10.50
L0944	Fork End (Standard) Bergeon 6767S & 7767S	EACH	£1.75
L0945	Pin End (Standard) Bergeon 6767S & 7767S	EACH	£1.05

Price breaks available, see website

Bergeon 6825



Bergeon 6825 - Swiss Made

- Tool for bracelets with spring bars, including Rolex
- Fantastic for removing spring bars in bracelets with curved ends
- Can be locked at a specific width
- Fine quality aluminium casting
- Very easy to handle
- Capacity: 10 to 30mm
- Length: 95mm
- Two fork positions (0 degrees and 45 degrees)
- Supplied with 2 reversible (standard size) forks in stainless steel
- Fine tips fork available (R38752)
- Pin body diameter Ø2.00mm

Fork dimensions (Fork width x tips width):

- Standard: 1.30mm x 0.33mm

Code	Description	UOM	Price
R38673	Spring Bar Tool, Bergeon 6825	EACH	£122.95
R38674	Spring Bar Tool Fork	EACH	£11.75

Bergeon 6825.PF (Fine Tips)



Bergeon 6825.PF - Swiss Made

- Tool for bracelets with spring bars, including Rolex
- Extra fine tips
- Fantastic for removing spring bars in bracelets with curved ends
- Can be locked at a specific width
- Fine quality aluminium casting

- Very easy to handle
- Capacity: 10 to 30mm
- Length: 95mm
- Two fork positions (0 degrees and 45 degrees)
- Supplied with 2 reversible (standard size) forks in stainless steel
- Standard tip fork available: R38674
- Pin body diameter Ø2.00mm

Fork dimensions (Fork width x tips width):
 • Fine: 1.10mm x 0.23mm

Code	Description	UOM	Price
R47763	Spring Bar Tool, Bergeon 6825.PF (Fine Ends)	EACH	£128.25
R38752	Spring Bar Tool Fork, Extra Fine	EACH	£11.50

Bergeon 7825 Spring Bar Tweezers



Bergeon Swiss Made - Spring Bar Tweezers

- Tool for bracelets with spring bars
- Fine quality aluminium casting
- Very easy to handle
- Allows the removal of the bracelet from the case, without removing the clasp
- Fine tips and arms allow easy access to the spring bar
- Replacement tips available
- Tip width 1.00mm
- Tip length 2.50mm

Code	Description	UOM	Price
T41939	Spring Bar Tool, Bergeon 7825	EACH	£94.95
T41940	Replacement Ends for Spring Bar Tool, Bergeon 7825-BR	PAIR	£98.95

Cousins

These high quality spring bar tools have an excellent feel about them. They are solid and durable with a knurled handle giving that extra grip capability.

The ends are easily replaced by unscrewing the chuck that holds them in place and they both come in their own wallet or holder for easy storage, transport and protection.

Replacements:

- Pin & Fork End = L0939A
- Large Fork = L0939B

Spring Bar Tool



- Reversible Pin Ø0.80mm & Fork Ø1.20mm
- Knurled handle
- Solid feel, good quality
- Gripping with chuck
- Handle length: 90mm
- Supplied in plastic wallet

Code	Description	UOM	Price
L37433	Spring Bar Tool	EACH	£11.05

Spring Bar Tool, Double Ended



- Reversible Pin Ø0.80mm & Fork Ø1.20mm
- With 6mm angled fork
- Knurled handle
- Solid feel, good quality
- Gripping with chuck
- Handle length: 110mm
- Supplied in push top plastic holder

Code	Description	UOM	Price
L37432	Spring Bar Tool, Double Ended	EACH	£19.95

Cousins Japanese Style



- High quality Japanese style spring bar tool
- Fork & pin end
- Double ended tips
- Knurled handle
- Made in Japan

Dimensions:
 TBA

Code	Description	UOM	Price
L55513	Spring Bar Tool, Japanese	EACH	£4.75
L55514	Pin & Fork End Spring Bar Tool, Japanese	EACH	£1.95

Cousins Swiss Style



- Tool for bracelets with spring bars, including Rolex
- Fantastic for removing spring bars in bracelets with curved ends
- Can be locked at a specific width
- Fine quality aluminium casting
- Very easy to handle
- Capacity: 10 to 25mm
- Length: 95mm
- Two fork positions (0 degrees and 45 degrees)
- Supplied with 4 (fine size) forks in stainless steel
- Pin body diameter Ø2.00mm
- Fork dimensions (Fork width x tips width): 1.10mm x 0.29mm
- Cousins high quality range

Other tip fork available: R38674

- Fork dimensions (Fork width x tips width): 1.30mm x 0.33mm

Code	Description	UOM	Price
S49428	Spring Bar Tool, Swiss Style	EACH	£39.95
S49429	Spring Bar Tool Forks	PACK*2	£11.50

Horotec 10.306 Spring Bar Tweezers



Horotec 10.306 Swiss Made - Spring Bar Tweezers
 • Stainless steel

- Mirror polished tips
- Sand blasted stainless steel body
- Very easy to handle
- Specifically manufactured to shorten both ends of the spring bar at the same time
- Allows the removal of the bracelet from the case, without removing the clasp
- Fine tips and arms allow easy access to the spring bar
- Tip width 1.40mm
- Overall length 120mm

Code	Description	UOM	Price
T49331	Spring Bar Tweezes, Horotec 10.306	EACH	£30.95

Value

Spring Bar Remover



- Ø0.80mm pin
- 3mm wide fork
- Hexagonal black acrylic handle
- Graduated in mm for measuring distance between lugs
- Length: 150mm
- Weight 30gms
- Made in India

Code	Description	UOM	Price
L31324	Spring Bar Remover	EACH	£1.25

Spring Bar Remover, Aluminium Deluxe



- Lightweight aluminium
- Ø0.80mm pin x2
- 2.5mm wide fork x 2
- Pins and forks are reversible
- Length: 130mm
- Japanese style
- Indian

Code	Description	UOM	Price
S42901	Spring Bar Remover, Aluminium Deluxe	EACH	£2.50

Spring Bar Remover, Fine



- Ø0.80mm pin
- 1.4mm wide fork
- With fine points and forks
- Length: 150mm
- Indian

Code	Description	UOM	Price
L31325	Spring Bar Remover, Fine	EACH	£1.75

Spring Bar Remover, Mini



- Ø0.80 pin
- 1.80mm wide fork
- Plastic grip
- Length 65mm
- Inexpensive if lost or damaged

Code	Description	UOM	Price
S37142	Spring Bar Remover, Mini	EACH	£1.50



Spring Bar Remover, Multi Pin

VALUE



- With 3 pins: Ø0.60, 0.80 & 1.00mm
- With forked end
- Knurled handle
- Stainless Steel
- Overall length 70mm

Code	Description	UOM	Price
S38767	Spring Bar Remover, Multi Pin	EACH	£1.65

- Hole punching diameter: Ø1.50mm or Ø2.00mm
- Box Joint
- Polished steel
- Suitable for watch straps, belts and other leather products
- Length 130mm

Code	Description	UOM	Price
P52407	Ø1.50mm Hole Punch Pliers	EACH	£9.95
P47110	Ø2.00mm Hole Punch Pliers	EACH	£9.95

Hole (Multi Size) Punching Plier, Cousins Swiss Style

COUSINSUK



Leather Watch Strap "Multi" Hole Punching Pliers.

Revolving platform system for cutting various diameter holes in leather

- Hole punching diameters: Ø0.60, 1.00, 1.30, 1.60 & 1.80mm
- Multi holes on a rotating platform
- Stainless steel pliers
- Overall length 170mm
- Spring loaded
- Suitable for belt holes and other leather products
- Cousins Swiss Style

Code	Description	UOM	Price
P55877	Multi Hole Strap Punch, Cousins Swiss Style	EACH	£9.95

Hole (Multi Size) Punching Plier, Maun

Maun



Leather Watch Strap "Multi" Hole Punching Pliers.

Revolving drum system for cutting various diameter holes in leather. Top quality in nickel plated steel with easy grip handles. Drum locating spring ensures accurate positioning of the punches. Easy to use with six hardened steel punches.

- Maun 2230-200
- Hole punching diameters: Ø2.00, 2.50, 3.00, 3.50, 4.00 & 4.50mm
- Multi hole punches on a rotating wheel
- Overall length 200mm
- Suitable for Belts Holes and other Leather Products

Code	Description	UOM	Price
P4815	Multi Hole Punching Plier, Maun 2230-200	EACH	£12.75

Hole (by Size) Punching Plier, Maun

Maun



Maun Leather Watch Strap Single Size Hole Punching Pliers.

- Hole punching diameters: 1.0, 1.6, 2.0, 2.4, 2.8 & 3.2mm
- Overall length 125mm
- Suitable for belt holes and other leather products

Code	Description	UOM	Price
P31545	Ø1.00mm Single Hole Plier	EACH	£13.45
P4769	Ø1.60mm Single Hole Plier	EACH	£13.45
P31546	Ø2.00mm Single Hole Plier	EACH	£13.45
P31547	Ø2.40mm Single Hole Plier	EACH	£13.45
P31548	Ø2.80mm Single Hole Plier	EACH	£13.45
P31549	Ø3.20mm Single Hole Plier	EACH	£13.45

Hole (by Size) Punching Plier, Bergeon

BERGEON



Bergeon 30225 - Swiss Made

- Leather Watch Strap Hole Making Plier
- Includes Ø1.00 & Ø1.50mm punches
- Length 160mm
- Pliers for punch
- Aluminium casting
- Pliers for punching holes in leather straps

Code	Description	UOM	Price
P1242	Bergeon Leather Watch Strap Hole Making Plier	EACH	£125.80

Hole (by Size) Punching Tool, Bergeon Professional

BERGEON



Bergeon 31228 - Swiss Made

Industry professionals will appreciate this new Swiss made tool from Bergeon. The tool allows the professional to make holes in nearly any strap that are

WATCH STRAP CUTTING & HOLE MAKING TOOLS

Hole Punching Plier

VALUE



Leather watch strap hole punching pliers. Box joint, plastic covered handles.

- Hole punching diameter: Ø1.80mm
- Spring loaded (double leaf springs)
- Sleeved arms
- Suitable for belt holes and other leather products
- Overall length 140mm

Code	Description	UOM	Price
S39497	Hole Punching Plier	EACH	£4.95

Hole Punching Plier, Cousins Swiss Style

COUSINSUK



Leather watch strap hole punching pliers for Ø1.50mm or Ø2.00mm holes

- Cousins Swiss Style
- Superb Swiss quality

perfectly equidistant and perpendicular to the existing ones.

- Perfect for high end, expensive or branded straps
- Delivered with tools for holes with a diameter of Ø1.60mm and Ø2.00mm
- Can be used on leather, fabric & even rubber straps
- Aluminium structure, ergonomic design
- Stylish black wooden storage case
- Swiss made

Code	Description	UOM	Price
S44354	Strap Hole Punch Tool, Bergeon Swiss	EACH	£695.00

Hole (Shaped) Punches

VALUE



Oval - Square - Rectangle

- For Leather Watch Straps without the traditional round punched holes
- 3 Punches in a set
- Oval 3x1.5mm
- Square 2x2mm
- Rectangle 3x1.5mm

Code	Description	UOM	Price
P19580	Special Shaped Hole Punch Set	PACK*3	£8.95

Hole Cutter (Rotating)

VALUE



Watch Strap Hole Making Tool - Rotating Cutter

- 2 punches: Ø1.50mm & Ø2.00mm
- Leaves very clean cut holes
- Very different from the traditional punch style
- Supplied with acrylic base to avoid damage to the punches

Code	Description	UOM	Price
P39415	Hole Cutting Tool	EACH	£7.95

Hole Cutter (Rotating), 6 Punches

VALUE



Watch Strap Hole Making Tool - Rotating Cutter - 6 Punches

- 6 Collets: 2x Ø2.50mm, 2x Ø2.00mm & 2x Ø1.50mm holes sizes
- Leaves very clean cut holes
- Very different from the traditional punch style

Code	Description	UOM	Price
S19579	Rotating Hole Cutting Tool	EACH	£14.95

Notch Cutter Pliers, A*F Swiss

A*F SWITZERLAND



For producing notches in watch straps in leather or synthetic material. A heavy duty tool, beautifully finished in highly polished stainless steel with hardened jaws ensuring a clean cut.

- For watch cases which have threaded or pressure bars
- Length 130mm
- 1.5mm or 3mm width of cuts
- 8mm depth of cut

Code	Description	UOM	Price
P47112	1.5 x 8mm Notch Cutters	EACH	£19.95
P47111	3 x 8mm Notch Cutters	EACH	£19.95

Notch Cutter Pliers, Cousins Swiss Style

COUSINSUK



For producing notches in watch straps in leather or synthetic material. A heavy duty tool, beautifully finished in highly polished stainless steel with hardened jaws ensuring a clean cut.

- For watch cases which have threaded or pressure bars
- Length 130mm
- 1.5mm or 3mm width of cuts
- 8mm depth of cut
- Spring loaded (double leaf springs)
- Superb Swiss quality
- Cousins Swiss style

Code	Description	UOM	Price
P49171	1.5 x 8mm Notch Cutters	EACH	£9.95
P49172	3 x 8mm Notch Cutters	EACH	£9.95

Notch Cutter Pliers, Indian

VALUE



For producing notches in watch straps in leather or synthetic material.

- Choice of 2 cut widths
- For watch cases which have threaded or pressure bars

Code	Description	UOM	Price
P44134	2mm Width Strap Notching Pliers	EACH	£4.95
P4915	3mm Width Strap Notching Pliers	EACH	£5.50

Notch Cutter Tool, Bergeon

BERGEON



Bergeon 6620 - Leather Watch Strap Notch Cutting Tool

- Pliers to cut multiple shapes into leather straps.
- Aluminium casting.
- Length 160 mm with adjustable strap guide.
- Supplied with 1 die, 3 half round punches & 3 rectangular punches.

Code	Description	UOM	Price
P2965	Bergeon Leather Watch Strap Notch Cutting Tool	EACH	£244.95
P53155	Half Round Punch, 2 x 5.8mm	EACH	£24.90
P53156	Half Round Punch, 4 x 5.8mm	EACH	£24.90
P53157	Half Round Punch, 6 x 8.5mm	EACH	£24.90
P53152	Rectangle Punch, 2 x 5mm	EACH	£24.90
P53153	Rectangle Punch, 4 x 5mm	EACH	£24.90
P53154	Rectangle Punch, 6 x 7.5mm	EACH	£24.90

Notch Cutter Tool, Quick Release Spring Bars

BERGEON



Notch Cutter Pliers - For Cutting Straps to Fit Quick Release Spring Bars

This pliers has been developed especially to cut a notch in a watch strap so that a quick release spring bar can be fitted.

- Be able to modify a watch strap so that you can fit quick release spring bars
- Takes seconds to use
- Modern top end watches already come with quick release spring bars
- Bergeon 30227
- Quick release spring bar set (for the latest European leather straps), our code S19187

Code	Description	UOM	Price
C32108	Bergeon Watch Strap Cutting Plier for Quick Release Spring Bars	EACH	£339.95
P35019	Center Pin For Bergeon Cutting Plier, Bergeon 30227-OE-06	EACH	£89.95

Clamps for Open Ended Straps



- Clamps the open ended straps in place to allow the adhesive to set
- Can be used with straps up to 28mm wide
- Protective felt pads wont damage the strap
- Felt pads: 22 x 28mm
- Overall size: 55 x 25 x 25 (L x W x H)
- An essential addition to your toolbox
- Pack*2

Code	Description	UOM	Price
545541	Clamps for Open Ended Straps	PACK*2	£3.95

CASE OPENING - BAUME & MERCIER

BAUME & MERCIER
MAISON D'HORLOGERIE GENEVE 1830

Universal Fitting Dies for Tools:

- Bergeon Swiss
- Horotec Swiss
- Swiss Style

Fitting:

- Universal = dies fit directly on to the tools
- Universal with Adapter = dies fit on to the tools usint adaptor C0318

Baume & Mercier Dies, Horotec, Universal

Universal Fitting Dies for Tools:

- Bergeon Swiss
- Horotec Swiss
- Swiss Style



Fitting:

- Universal = dies fit directly on to the tools

Dimensions are the outside edge of the teeth diameter.

Code	Description	UOM	Price
C30934	Ø25mm (B&M), Horotec, Universal	EACH	£34.95
C30935	Ø30mm (B&M), Horotec, Universal	EACH	£34.95
C30936	Ø30mm (B&M), Horotec, Universal	EACH	£34.95

Baume & Mercier Dies with Holder, Non Swiss

VALUE



- Three different diameter dies, inside diameters: Ø21, 26 & 29mm
- Die holder
- Specifically for Baume & Mercier watches

Supplied with a Die Holder & 3 dies (Ø21, 26 & 29mm) for Baume & Mercier case backs. These dies will only specifically fit the tool handle supplied in this set. Dimensions are the outside edge of the teeth diameter.

Code	Description	UOM	Price
B37141	Baume and Mercier Opener	EACH	£19.95

WATCH CASE & WATCH GLASS TOOLS

Watch Case Back Removing:

More and more watches these days come with a screw on case back. These feature small depressions spaced around the edge of the case back, designed to provide a gripping point for the use of a wrench case opener. Knowing how to use one of these screw type case openers properly will prevent you from damaging the watch.

How to use:

1. Place the wrist watch face down in a protective watch holder.
2. Having picked the correct shaped tool bits (by matching them to the indentations on the case) or die for the case you are about to work on, insert them firmly into the screwback tool.
3. Adjust the width of the bits on the tool to match the size of the screw down case back on the watch.
4. Matching up the tool bits and the indentations on the case back, apply firm downward pressure, hold the watch or watch holder and turn the wrench to loosen the back. If using a benchtop tool the same principle applies.

Baume & Mercier Dies with Holder, A*F Swiss



A*F Swiss - Case Back Opening Tools

A*F 167.781 (C9577) is supplied with a Die Holder & 3 dies (Ø21, 26 & 29mm) for Baume & Mercier case backs. The dies will also fit any of our universal case back tools listed below. Dimensions are the outside edge of the teeth diameter.

Universal Fitting Dies for Tools:

- Bergeon Swiss
- Horotec Swiss
- Swiss Style

Fitting:

- Universal = dies fit directly on to the tools

Code	Description	UOM	Price
C9577	A*F 167.781 Baume & Mercier Opening Tool	EACH	£184.75

Universal Fitting Dies for Tools:

- Bergeon Swiss
- Horotec Swiss
- Swiss Style

Fitting:

- Universal = dies fit directly on to the tools
- Universal with Adapter = dies fit on to the tools using adaptor C0318

Breitling Dies (Universal), A*F Swiss



A*F Swiss - 18 piece Set

Universal Fitting Dies for Tools:

- Bergeon Swiss
- Horotec Swiss
- Swiss Style

Fitting: Universal with Adapter = dies fit on to the tools using adaptor C0318 or C39846. Superb quality, exact sizes to avoid damaging case backs.

Die inside diameters, all with 15 edges unless stated:

- Ø19.00mm (No.1) - 13 edges
- Ø23.50mm (No.2) - 13 edges

Watch Strap Keepers

See Page 630



- Ø26.00mm (No.3) - 13 edges
- Ø26.50mm (No.4) - 13 edges
- Ø26.70mm (No.7)
- Ø29.60mm (No.8)
- Ø30.60mm (No.5) - 14 edges
- Ø31.10mm (No.9)
- Ø33.50mm (No.10)
- Ø33.90mm (No.11)
- Ø34.40mm (No.12)
- Ø36.00mm (No.13)
- Ø36.80mm (No.6) - 14 edges
- Ø37.00mm (No.14)
- Ø37.90mm (No.15)
- Ø38.20mm (No.16)
- Ø43.30mm (No.17)
- Ø44.10mm (No.18)

Code	Description	UOM	Price
D38827	Breitling Die Set, A*F Swiss	PACK*18	£785.00
D38828	Ø19.00mm (No.1) Die - 13 Edges	EACH	£39.95
D38829	Ø23.50mm (No.2) Die - 13 Edges		£0.00
D38830	Ø26.00mm (No.3) Die - 13 Edges	EACH	£39.95
D38831	Ø26.50mm (No.4) Die - 13 Edges	EACH	£39.95
D38834	Ø26.70mm (No.7) Die	EACH	£39.95
D38835	Ø29.60mm (No.8) Die		£0.00
D38832	Ø30.60mm (No.5) Die - 14 Edges (Set Only)		£0.00
D38836	Ø31.10mm (No.9) Die		£0.00
D38837	Ø33.50mm (No.10) Die		£0.00
D38838	Ø33.90mm (No.11) Die		£0.00
D38839	Ø34.40mm (No.12) Die		£0.00
D38840	Ø36.00mm (No.13) Die		£0.00
D38833	Ø36.80mm (No.6) Die - 14 Edges		£0.00
D38841	Ø37.00mm (No.14) Die		£0.00
D38842	Ø37.90mm (No.15) Die		£0.00
D38843	Ø38.20mm (No.16) Die		£0.00
D38844	Ø42.30mm (No.17) Die		£0.00
D38845	Ø44.10mm (No.18) Die (Set Only)		£0.00

Breitling Dies (Universal), Cousins



Elegant "Black" Presentation Wooden Case - 15 piece Set & Individuals -

Universal Fitting Dies for Tools:

- Bergeon Swiss
- Horotec Swiss
- Swiss Style

Fitting: Universal with Adapter = dies fit on to the tools using adaptor C0318 or C39846

Die inside diameters with 15 edges (unless stated):

- Ø19.00mm (No.1)
- Ø19.00mm (No.16) - 13 edges*
- Ø23.50mm (No.2)
- Ø23.80mm (No.17) - 13 edges*
- Ø26.00mm (No.3)
- Ø26.20mm (No.18) - 13 edges*
- Ø26.50mm (No.4)
- Ø26.80mm (No.5)
- Ø26.80mm (No.19) - 13 edges*
- Ø29.50mm (No.6)

- Ø30.40mm (No.20) - 14 edges*
 - Ø33.50mm (No.7)
 - Ø34.50mm (No.8)
 - Ø36.00mm (No.9) - 14 edges
 - Ø36.00mm (No.10) -15 edges
 - Ø37.00mm (No.11)
 - Ø38.20mm (No.12)
 - Ø38.50mm (No.13)
 - Ø42.50mm (No.14)
 - Ø44.00mm (No.15)
- * dies are not included in the set

Size: 300 x 250 x 40mm

Weight: 1.7kg

Stainless steel dies

Code	Description	UOM	Price
C33486	Die Set for Breitling	PACK*15	£295.00
C33959	Ø19.00mm (No.1) Die	EACH	£10.95
C40376	Ø19.00mm (No.16) Die - 13 Edges*	EACH	£19.95
C33960	Ø23.50mm (No.2) Die	EACH	£11.95
C40377	Ø23.80mm (No.17) Die - 13 Edges*	EACH	£19.95
C33961	Ø26.00mm (No.3) Die	EACH	£19.95
C40378	Ø26.20mm (No.18) Die - 13 Edges*	EACH	£21.95
C33962	Ø26.50mm (No.4) Die	EACH	£19.95
C33963	Ø26.80mm (No.5) Die	EACH	£19.95
C40379	Ø26.80mm (No.19) Die - 13 Edges*	EACH	£21.95
C33964	Ø29.50mm (No.6) Die	EACH	£19.95
C40380	Ø30.40mm (No.20) Die - 14 Edges*	EACH	£27.95
C33965	Ø33.50mm (No.7) Die	EACH	£21.95
C33966	Ø34.50mm (No.8) Die	EACH	£21.95
C33967	Ø36.00mm (No.9) Die - 14 Edges	EACH	£21.95
C33968	Ø36.00mm (No.10) Die	EACH	£21.95
C33969	Ø37.00mm (No.11) Die	EACH	£21.95
C33970	Ø38.20mm (No.12) Die	EACH	£21.95
C33971	Ø38.50mm (No.13) Die	EACH	£21.95
C33972	Ø42.50mm (No.14) Die	EACH	£23.95
C33973	Ø44.00mm (No.15) Die	EACH	£23.95

Breitling Dies (Universal), Horotec



Universal Fitting Dies for Tools:

- Bergeon Swiss
- Horotec Swiss
- Swiss Style

Fitting:

• Universal = dies fit directly on to the tools

Code	Description	UOM	Price
D52322	Ø34mm (15 Sides) Breitling, Universal	EACH	£44.50
C32440	Ø35mm (15 Sides) Breitling, Universal	EACH	£46.50
D52323	Ø36mm (12 Sides) Breitling, Universal	EACH	£46.50
C32441	Ø36mm (15 Sides) Breitling, Universal	EACH	£46.50
C22164	Ø37mm (15 Sides) Breitling, Universal	EACH	£46.50
C32442	Ø38mm (15 Sides) Breitling, Universal	EACH	£42.75



Breitling Dies (Universal), USA



Breitling Dies - Made in USA

- Breitling case back dies
- High quality, stainless steel dies
- Machined perfectly to fit the Breitling cases
- For Breitling case number see "more info" and additional images
- Made in USA

Universal Fitting Dies for Tools:

- Bergeon Swiss
- Horotec Swiss
- Swiss Style

Fitting:

• Universal = dies fit directly on to the tools

Code	Description	UOM	Price
B55992	5 Edges, TBA Die, USA	EACH	£65.95
B55993	11 Edges, Ø18.20mm Die, USA	EACH	£65.95
B56009	12 Edges, TBA Die, USA	EACH	£65.95
B56010	12 Edges, TBA Die, USA	EACH	£65.95
B55996	13 Edges, Ø23.00mm Die, USA	EACH	£65.95
B55994	13 Edges, Ø25.40mm Die, USA	EACH	£65.95
B55995	13 Edges, Ø26.00mm Die, USA	EACH	£65.95
B55998	14 Edges, Ø30.20mm Die, USA	EACH	£65.95
B55999	14 Edges, Ø30.20mm Die, USA	EACH	£65.95
B55997	14 Edges, Ø36.00mm Die, USA	EACH	£65.95
B56008	15 Edges, Ø28.30mm Die, USA	EACH	£65.95
B56006	15 Edges, Ø30.80mm Die, USA	EACH	£65.95
B56004	15 Edges, Ø33.30mm Die, USA	EACH	£65.95
B56002	15 Edges, Ø33.50mm Die, USA	EACH	£65.95
B56005	15 Edges, Ø33.30mm Die, USA	EACH	£65.95
B56000	15 Edges, Ø36.50mm Die, USA	EACH	£65.95
B56001	15 Edges, Ø37.80mm Die, USA	EACH	£65.95
B56003	15 Edges, Ø41.80mm Die, USA	EACH	£65.95
B56007	15 Edges, TBA Die, USA	EACH	£65.95

CASE OPENING - CITIZEN

Universal Fitting Dies for Tools:

- Bergeon Swiss
- Horotec Swiss
- Swiss Style

Fitting:

• Universal = dies fit directly on to the tools

Citizen Dies, Horotec, Universal

Universal Fitting Dies for Tools:

- Bergeon Swiss
- Horotec Swiss
- Swiss Style

Fitting:

• Universal = dies fit directly on to the tools



Code	Description	UOM	Price
C22163	Horotec, Citizen Ø35mm Aqualand Die	EACH	£39.95

CASE OPENING - GUCCI

Gucci Style Case Openers

Small tool designed specially to open Gucci-type case backs with notches. Swiss & Non Swiss made.

- Open Gucci case backs in a snap!
- With this specially designed Gucci watch opener, you simply insert the hook into the notch on the watch case back and pop it off.
- A real time saver!

Gucci Style

VALUE



Have you ever been presented with a Gucci watch to repair, only to realize it will take hours of struggling to get it open? No longer.

- Open Gucci case backs in a snap!
- With this specially designed Gucci watch opener, you simply insert the hook into the notch on the watch case back and pop it off.
- A real time saver!

Size: 100 x 10 x 6mm

Code	Description	UOM	Price
C36095	Gucci Style	EACH	£1.95

Gucci Style, A*F Swiss



A*F 167.448 - Swiss Made

Small tool designed specially to open Gucci-type case backs with notches. Swiss made.

- Open Gucci case backs in a snap!
- With this specially designed Gucci watch opener, you simply insert the hook into the notch on the watch case back and pop it off.
- A real time saver!
- Length 130mm

Code	Description	UOM	Price
C48017	Gucci Style, A*F Swiss	EACH	£10.95

New Jaxa Watch Case Opener specifically designed to include the opening of large watches

- The ergonomic shape provides a firm and comfortable grip
- Opens diameters from Ø18mm to Ø62mm
- Supplied with 4 sets bits (3 each shape)
- Supplied in box
- Bergeon 2819.08

Code	Description	UOM	Price
C32160	Jaxa, Bergeon 2819.08	EACH	£139.95
C0329	Flat (A) Tool Bit, Bergeon 2819.A	EACH	£2.95
C0330	Notch (B) Tool Bit, Bergeon 2819.B	EACH	£2.95
C0331	Round Hole (C) Tool Bit, Bergeon 2819.C	EACH	£2.95
C0332	Oyster (D) Tool Bit, Bergeon 2819.D	EACH	£2.95

LG Master Wrench, U.S.A



Case Back Tool - LG Master Wrench - Made in U.S.A

A finely made case opener in steel with black finish. Knurled handle for maximum grip. Opens all types and sizes of cases with backs either knurled, polygonal, notched or with holes. Triple locking system adapts to backs with odd or even number of holes. The case back can be held in the opener after removal. Supplied with 4 sets of 3 interchangeable pins for all types of cases.

- Opens cases up to Ø43mm
- Knurled handle for maximum grip
- Opens all types and sizes of cases with backs either knurled, polygonal, notched or with holes
- Triple locking system adapts to backs with odd or even number of holes
- The case back can be held in the opener after removal
- Supplied complete with 4 sets of 3 interchangeable pins for all types of cases
- Made in U.S.A

Code	Description	UOM	Price
C0334	Jaxa Style LG Master Wrench, USA	EACH	£68.95
C0334A	Bit "1" (Pin), for LG Master Wrench	PACK*3	£6.25
C0334B	Bit "2" (Flat), for LG Master Wrench	PACK*3	£6.25
C0334C	Bit "3" (Notch), for LG Master Wrench	PACK*3	£6.25
C0334D	Bit "4" (Oyster), for LG Master Wrench	PACK*3	£6.25

Single Handed (Regular)

VALUE



Jaxa Style Case Back Opener

- Universal key for opening and closing screw back watch cases.
- All steel body with aluminum handle.
- Supplied with 4 sets of pins in a wooden case

- Opens case backs up to Ø39mm

Replacement Tool Bits C0333A

Code	Description	UOM	Price
C0333	Single Handle (Regular)	EACH	£5.95
C0333A	Tool Bits for Single Handed (Regular)	PACK*12	£2.30

Single Handed (up to Ø60mm)

VALUE



Jaxa Style Case Opener including Large Diameters - Single Handed

- Modified to open case backs of larger watches
- Opens diameters from 19mm to 60mm
- Packed in a light weight cardboard box
- 4 (x3) Different Sets of Bits
- Replacement bits C0333A
- Made in India

Code	Description	UOM	Price
C31300	Single Handle (up to Ø60mm)	EACH	£12.95

Single Handed (up to Ø60mm), Light Weight

VALUE



Jaxa Style Case Opener including Large Diameters - Light Weight

- Modified to open case backs of larger watches
- Opens diameters from 18mm to 62mm
- Packed in a light weight cardboard box
- 4 (x3) Different Sets of Bits
- Lightweight composite plastic

Code	Description	UOM	Price
C35123	Single Handed (up to Ø60mm), Light Weight	EACH	£19.95
C47759	Tool Bits for Single Handed (Lightweight)	PACK*12	£7.95

Double Handed (up to Ø60mm)

VALUE



Jaxa Style Case Opener, Double Handed with Large Diameters

- For big size cases
- From Ø18 to 62mm watch case

CASE OPENING - JAXA & JAXA STYLE

Bergeon Swiss, Jaxa



Case Back Tool - Bergeon Swiss

• 4 (x4) different key tips

Code	Description	UOM	Price
C35303	Double Handed (up to Ø60mm)	EACH	£22.95

CASE OPENING - OMEGA

Universal Fitting Dies for Tools:

- Bergeon Swiss
- Horotec Swiss
- Swiss Style

Fitting:

- Universal = dies fit directly on to the tools
- Universal with Adapter = dies fit on to the tools using adaptor C0318

Omega Dies & Die Holder, Horotec



Horotec Swiss 07.304

Supplied with a Die Holder & 2 metal dies (5 pins) Ø20 & 30mm for Omega Seamaster ladies & Gents case backs. The dies will also fit any of our universal case back tools listed below.

Universal Fitting Dies for Tools:

- Bergeon Swiss
- Horotec Swiss
- Swiss Style

Fitting:

- Universal = dies fit directly on to the tools listed above

Code	Description	UOM	Price
M19219	Die Holder Plus Ø20 & 30mm Dies, Horotec	EACH	£79.95
M19220	Ø20mm (Omega Seamaster) Horotec, Universal	EACH	£23.50
M19221	Ø30mm (Omega Seamaster) Horotec, Universal	EACH	£28.95
M31381	Ø33mm (Omega Seamaster) Horotec, Universal	EACH	£29.50
M31382	Ø42mm (Omega Seamaster) Horotec, Universal	EACH	£26.95



Omega Dies, Seamaster, Universal



Universal Fitting Dies for Tools:

- Bergeon Swiss
- Horotec Swiss
- Swiss Style

Fitting: Universal = dies fit directly on to the tools

Universal Omega Seamaster

- 4 pieces
- 5 Pin Steel Dies
- Die Ø20, 30, 33 & 42mm
- Weight 230g

Code	Description	UOM	Price
C33482	Omega Dies, Seamaster, Universal	PACK*4	£46.50

Omega Dies, Seamaster, Universal



Universal Fitting Dies for Tools:

- Bergeon Swiss
- Horotec Swiss
- Swiss Style

Fitting: Universal with Integral Adapter = dies fit on to the tools using adaptor C0318 or C39846

- 4 pieces
- 5 Pin Steel Dies
- Die Ø20, 30, 33 & 42mm
- Weight 280g

Code	Description	UOM	Price
C33483	Omega Dies, Seamaster, Universal	PACK*4	£49.95

CASE OPENING - PANERAI

Individual Dies, Panerai

- Panerai dies
- 12 sided dies
- Horotec Swiss

Universal Fitting Dies for Tools:

- Bergeon Swiss
- Horotec Swiss
- Swiss Style

Fitting:

- Universal = dies fit directly on to the tools

Code	Description	UOM	Price
C22166	Ø30mm (Panerai) Horotec, Universal	EACH	£50.95

C22167	Ø35mm (Panerai) Horotec, Universal	EACH	£50.95
C22168	Ø39mm (Panerai) Horotec, Universal	EACH	£53.95
C22169	Ø42mm (Panerai) Horotec, Universal	EACH	£62.95

Set of Dies, Panerai (Hand Held)



- Panerai dies
- 12 sided dies
- Set of 4
- Sizes: Ø35, 40, 42 & 44mm (Internal diameters, flat side to flat side)
- Hand Held
- Anodised steel

Code	Description	UOM	Price
D32767	Panerai Die Set	PACK*4	£49.95

CASE OPENING - ROLEX

Rolex Dies, Horotec



Horotec Swiss

Dimensions are the outside edge of the teeth diameter.

Universal Fitting Dies for Tools:

- Bergeon Swiss
- Horotec Swiss
- Swiss Style

Fitting:

- Universal = dies fit directly on to the tools

Code	Description	UOM	Price
R32676	Ø18.5mm (Rolex Oyster) Horotec, Universal	EACH	£20.50
R32677	Ø20.2mm (Rolex Oyster) Horotec, Universal	EACH	£18.50
R32678	Ø22.5mm (Rolex Oyster) Horotec, Universal	EACH	£18.50
R32679	Ø26.5mm (Rolex Oyster) Horotec, Universal	EACH	£18.50
R32680	Ø28.3mm (Rolex Oyster) Horotec, Universal	EACH	£18.50
R32681	Ø29.5mm (Rolex Oyster) Horotec, Universal	EACH	£18.50
R51620	Ø34.0mm (Rolex Oyster) Horotec, Universal	EACH	£19.50
R51621	Ø36.5mm (Rolex Sea Dweller) Horotec, Universal	EACH	£19.75

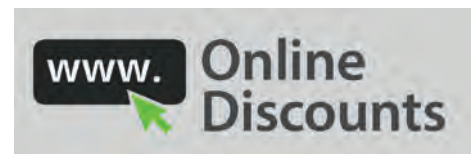

Rolex Dies with Adaptor, Bergeon



Bergeon Swiss

Bergeon 5538 set of 6 milled dies (Ø18.5, 20.2, 22.5, 26.5, 28.3, 29.5mm) and adaptor 5538T for Rolex Oyster watch cases. These dies will also fit any of our universal case back tools listed below using adaptor C0318 (included). Dimensions are the outside edge of the teeth diameter.

Universal Fitting Dies for Tools:

- Bergeon Swiss
- Horotec Swiss
- Swiss Style

Fitting: Universal with Adapter = dies fit on to the tools listed above using adaptor C0318 (included)

For replacement dies see from our code D50421

Code	Description	UOM	Price
C0318A	Rolex Oyster Adaptor and Dies, Bergeon 5538	EACH	£154.95

Rolex Dies with Rounded Grooves, Bergeon



Bergeon Swiss

Bergeon 7001.B set of 4 specially milled dies with rounded grooves (Ø18.5, 24.4, 29.6, 32mm) for new style Rolex watch case backs. Available in a set or individually these dies will also directly fit any of our universal case back tools listed below. Dimensions are the outside edge of the teeth diameter.

Universal Fitting Dies for Tools:

- Bergeon Swiss
- Horotec Swiss
- Swiss Style

Fitting: Universal = dies fit directly on to the tools

Code	Description	UOM	Price
C47035	Rolex Oyster (Round Grooved Cases) Die Set	PACK*4	£175.00

C47036	Ø18.5mm (Rolex) Bergeon, Universal	EACH	£54.95
C47037	Ø24.4mm (Rolex) Bergeon, Universal	EACH	£54.95
C47038	Ø29.6mm (Rolex) Bergeon, Universal	EACH	£54.95
C47039	Ø32mm (Rolex) Bergeon, Universal	EACH	£54.95

Rolex Dies with Wrench, Bergeon



Bergeon Swiss

Bergeon 5537 set of 6 milled dies (Ø18.5, 20.2, 22.5, 26.5, 28.3, 29.5mm) and wrench for Rolex Oyster watch cases. These dies will also fit any of our universal case back tools listed below using adaptor C0318 or C39846. Dimensions are the outside edge of the teeth diameter.

Universal Fitting Dies for Tools:

- Bergeon Swiss
- Horotec Swiss
- Swiss Style

Fitting: Universal with Adapter = dies fit on to the tools listed above using adaptor C0318 or C39846

Code	Description	UOM	Price
C0314	Rolex Oyster Case Opener, Bergeon 5537	EACH	£114.95
C50436	Wrench for Case Back Opener Dies	EACH	£18.50
D50421	Ø18.50mm (Rolex) Universal	EACH	£18.95
D50422	Ø20.20mm (Rolex) Universal	EACH	£18.95
D50423	Ø22.50mm (Rolex) Universal	EACH	£18.95
D50424	Ø26.50mm (Rolex) Universal	EACH	£18.95
D50425	Ø28.30mm (Rolex) Universal	EACH	£18.95
D50426	Ø29.50mm (Rolex) Universal	EACH	£18.95

Rolex Dies with Wrench, Non Swiss



Set of 6 milled dies (Ø18.5, 20.2, 22.5, 26.5, 28.3, 29.5mm) and wrench for Rolex Oyster watch cases. These dies will also fit any of our universal case back tools listed below using adaptor C0318. Dimensions are the outside edge of the teeth diameter.

Universal Fitting Dies for Tools:

- Bergeon Swiss
- Horotec Swiss
- Swiss Style

Fitting: Universal with Adapter = dies fit on to the tools listed above using adaptor C0318 or C39846

Code	Description	UOM	Price
C35042	Rolex Oyster Case Opener	EACH	£18.95

Rolex Dies with Wrench Plus, Non Swiss

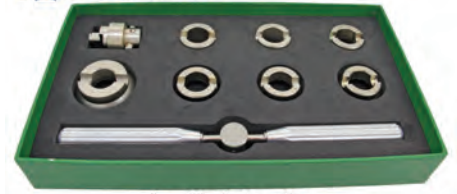

Individuals



Excellent high quality, Swiss style case back tool for Rolex Oyster & Rolex Deep Sea Dweller.

Set of 7 milled dies, 6 most popular (Ø18.5, 20.2, 22.5, 26.5, 28.3, 29.5mm) plus also the "Deep Sea Dweller" die Ø36.5mm. Included also is a stainless steel wrench for Rolex Oyster watch cases and an adaptor die to enable the dies to be fitted to any of our universal case back tools listed below. Dimensions are the outside edge of the teeth diameter.

Universal Fitting Dies for Tools:

- Bergeon Swiss
- Horotec Swiss
- Swiss Style

Fitting: Universal with Adapter* = dies fit on to the tools listed above using adaptor supplied (included)

Code	Description	UOM	Price
C39845	Set of Dies, Rolex (with Wrench, Plus) Non Swiss	EACH	£69.95
C39848	Wrench for Case Back Opener Dies	EACH	£15.95
C39846	Rolex Oyster Adaptor, Non Swiss	EACH	£19.95
C39849	Ø18.50mm (Rolex) Universal*	EACH	£9.95
C39850	Ø20.20mm (Rolex) Universal*	EACH	£9.95
C39851	Ø22.50mm (Rolex) Universal*	EACH	£9.95
C39852	Ø26.50mm (Rolex) Universal*	EACH	£9.95
C39853	Ø28.30mm (Rolex) Universal*	EACH	£9.95
C39854	Ø29.50mm (Rolex) Universal*	EACH	£9.95
C39847	Ø36.50mm (Rolex) Universal*, Deep Sea Dweller	EACH	£14.95

Rolex Dies with Holder, Sea Dweller



- Ridged, plastic handle for extra grip, Ø70mm
- Overall length 70mm

Excellent hand held tool for opening case backs. Includes case back die for the Rolex Sea Dweller (Die Ø36.50mm). Easy to use with one hand. The die supplied will also fit any of our universal case back tools listed below using adaptor C0318 or C39846. Dimensions are the outside edge of the teeth diameter.

Universal Fitting Dies for Tools:

- Bergeon Swiss
- Horotec Swiss

- Swiss Style

Fitting: Universal with Adapter = dies fit on to the tools listed above using adaptor C0318 or C39846

Code	Description	UOM	Price
C39292	Rolex Sea Dweller Holder & Die	EACH	£24.95

Rolex Dies with Holder, LG Openall, U.S.A



Case Back Tool - LG Openall Rolex - Made in U.S.A

A compact case opener of robust construction with cast aluminium frame finished in blue/grey enamel. Designed to be held in the bench vice or the screw to the bench base. Specially suitable for effortless opening of all Rolex style watch cases. Supplied with 6 tempered knurled dies which interlock perfectly with the case back.

The central threaded shaft, fitted with the appropriate die is screwed down on the watch. The integral spring ensures a firm uniform pressure. Nothing can slip, slide or jump. The torsion bar is then used to provide enough leverage to open the most stubborn case back. The built-in adjustable case holder grips all sizes of watches.

- Designed to be held in a bench vice
- Specially suitable for effortless opening of all Rolex style watch cases
- Supplied with 6 tempered knurled dies
- Diameters: Ø18.00, 20.00, 22.50, 26.50, 23.80, 29.50mm (dimensions are the outside edge of the teeth diameter)
- Weight: 590g
- Made in USA

Use in conjunction with the LG master wrench (C0334) to open case backs other than Rolex. Simply insert the pin supplied into the shaft of the Openall which will then fit to the wrench. The wrench can then be held firmly and snugly in place in slots in case backs by screwing the Openall down.

Code	Description	UOM	Price
C0315	Rolex LG Openall, U.S.A	EACH	£71.95
C55603	Case Holder for LG Opener	EACH	£6.95
C20987	Ø18mm Oyster Die	EACH	£6.50
C20986	Ø20mm Oyster Die	EACH	£6.50
C0315A	Ø22.5mm Oyster Die	EACH	£6.50
C7052	Ø26mm Oyster Die	EACH	£6.50
C7053	Ø28mm Oyster Die	EACH	£6.50
C7844	Ø29mm Oyster Die	EACH	£6.50

CASE OPENING - SNAP-ON BACKS



Opening a watch case is a fundamental skill that anyone dealing in watches, be it repairs and services or simple battery changes, needs to have. However, by not using the right tools and techniques, it is easy to damage a watch case, which would obviously make your customers' very unhappy.

Opening your watch case can be easy, all you need is a watch case opener and case holder. Here is our large selection and variety of press fit, snap on watch case back type openers. You will surely be able to find one to suit you and your methods of working.

How to use:

1. Turn the watch case over in your hands so the glass is facing down, or if appropriate depending on the watch style, place in a case holder.
2. Find the slot or opening groove around the edge of case back for the placement of the case opener. (Run the edge of a fingernail around the full circumference of the case back to feel for the grooves as they may not be easily seen).
3. Place the blade of the case opener into the slot or groove that you have located on the watch back.
4. Pry up on the case back with the blade of the case opener until the back pops off.
5. Do not use excessive force either when lifting the case back off or pressing it back on, this may cause damage to the case or even the movement inside
6. Make sure the seal (gasket) is in good condition (if it has one) before you replace the case back. This will better protect your watch against water intrusion than trying to press it back on as tightly as you can get it.

Bench Top Case Opener, Greiner

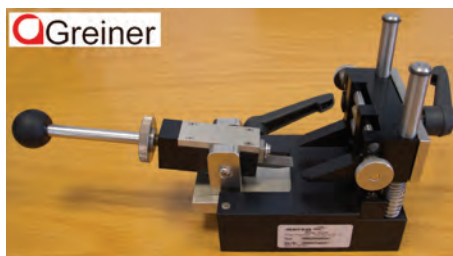

The most advanced and professional watch case snap on back opener on the market. The Greiner Timoknack can open all watch cases with push on/snap on case backs. Its ergonomic & specialised design makes it great for any especially tough job or for continuous use in the busy workshop. The expert construction design attaches great importance to opening of the case backs without damaging the case.

- Rubber pad for the watch case to rest on
- Half round recesses for the crown
- Case is then secured with 2 movable supporting jaws
- Super controlled blade movement with an extended screw in motion
- Spare blade for Greiner case back opener "Timoknack" (C47917)
- Swiss made
- Greiner 38000

See PDF for full details

Code	Description	UOM	Price
C47917	Greiner Timoknack Watch Holding Case Opener	EACH	£475.00
C47918	Greiner Timoknack Blade	EACH	£26.95

Bench Top Case Openers

Case Back Opening Tools - Snap On Watch Case Backs

For easy removal of the tightest of snap on case backs. Accurate positioning of the case opening blade coupled with a steady smooth screw in action of the blade provides successful case opening every time.

- Professional Choice
- No Risk of Injury
- Controlled & Safe
- Suitable for Semi Skilled Personnel

A*F Swiss Watch Holding Case Opener



A*F Swiss

- Reinforces the professional watchmaker's hands and opens the watch more reliably than a hand held blade
- Cover and case are protected, so the opening of the case can also be carried out by semi-skilled personnel
- Perfect for battery exchange service
- No risk of injury
- Plastic body

Code	Description	UOM	Price
C9865	A*F Swiss Watch Holding Case Opener	EACH	£54.95

A*F Swiss Blade

- For Tool reference C9865



Code	Description	UOM	Price
C9865A	A*F Swiss Blade	EACH	£6.75



Chinese Watch Holding Case Opener

VALUE



Chinese - Superior Quality Version

Reinforces the professional watchmaker's hands and opens the watch more reliably than a hand held blade. Cover and case are not damaged, so the opening of the case can also be carried out by semi-skilled personnel.

- Open cases up to Ø55mm
- Perfect for battery exchange service
- No risk of injury
- Spare blade available (reference C40364)
- Overall size 160 x 65 x 50mm
- 450g

Code	Description	UOM	Price
C40363	Chinese Watch Holding Case Opener	EACH	£64.95

Chinese Blade

- For Tool reference C40363



Code	Description	UOM	Price
C40364	Chinese Blade	EACH	£6.50

Case Delrin Support

- For Tool reference C40363



Code	Description	UOM	Price
C53042	Case Delrin Support	EACH	£3.95

Indian Watch Holding Case Opener

VALUE



Indian - Economy Version

Reinforces the professional watchmaker's hands and opens the watch more reliably than a hand held blade. Cover and case are not damaged, so the opening of the case can also be carried out by semi-skilled personnel.

- Perfect for battery exchange service
- No risk of injury
- Supplied with spare blade
- Max case opening width Ø39mm

Code	Description	UOM	Price
C19024	Indian Watch Holding Case Opener	EACH	£14.50

Indian Blade

- For Tool reference C19024



Code	Description	UOM	Price
C31544	Indian Blade	EACH	£1.50

Case Knives

Snap On Watch Case Backs - Hand Held

A selection of the most popular hand held "Knife Style" snap on watch case back opening tools.

- Bergeon
- Wenger
- Chinese
- Indian
- Extra long (XL)
- Curved blade
- Metal, plastic or PVC grips

Fixed Blade, Bergeon 4932



Bergeon Swiss professional watchmakers case knife. Precisely beveled blade made by the famous "Swiss Army" knife manufacturer Wenger.

- Watch case opener with metal handle
- Stainless steel blade
- Length 110mm
- Bergeon Swiss
- Bergeon 4932

Code	Description	UOM	Price
C0339	Fixed Blade, Bergeon 4932	EACH	£16.75

Fixed Blade, Dumont (Horotec 07.008)



- Dumont Swiss (Horotec 07.008)
- Ideal for both left and right handed user
- For snap on watch case backs

Code	Description	UOM	Price
C12496	Fixed Blade, Dumont (Horotec 07.008)	EACH	£31.95

Fixed Blade, Metal Handle



- Single blade case opener

- Metal handle
- Overall length 115mm
- Handle length 85mm
- Made in China

Code	Description	UOM	Price
C37431	Fixed Blade, Metal Handle	EACH	£7.95

Fixed Blade, Metal Handle, Curved Blade



- Single blade case opener
- Curved blade
- Metal handle
- Overall length 130mm
- Handle length 95mm
- Blade length 20mm
- Blade width 9mm
- Inexpensive to replace if lost
- Made in India

Code	Description	UOM	Price
K39640	Fixed Blade, Metal Handle, Curved Blade	EACH	£1.50

Fixed Blade, Metal Handle XL



- Single blade case opener
- Extra long (XL)
- Metal handle
- Overall length 160mm
- Handle length 115mm
- Blade length 50mm
- Blade width 9mm
- Inexpensive to replace if lost
- Made in India

Code	Description	UOM	Price
K39638	Fixed Blade, Metal Handle XL	EACH	£2.95

Fixed Blade, Plastic Handle



- Single blade case opener
- Plastic handle
- Overall length 115mm
- Handle length 85mm
- Inexpensive to replace if lost
- Made in India

Code	Description	UOM	Price
K39635	Fixed Blade, Plastic Handle	EACH	£2.25

Fixed Blade, PVC Handle



- Single blade case opener
- PVC coated handle
- Overall length 115mm
- Handle length 90mm
- Inexpensive to replace if lost
- Made in India

Code	Description	UOM	Price
K39634	Fixed Blade, PVC Handle	EACH	£1.50

Fixed Blade, PVC Handle, Broad Blade



- Single blade case opener
- PVC coated handle
- Overall length 130mm
- Handle length 100mm
- Blade length 33mm
- Blade width 15mm
- Inexpensive to replace if lost
- Made in India

Code	Description	UOM	Price
K39639	Fixed Blade, PVC Handle, Broad Blade	EACH	£1.50

Fixed Blade, Wooden Handle



- Single blade case opener
- Wooden, riveted handle
- Overall length 130mm
- Handle length 100mm
- Blade length 37mm
- Blade width 15mm
- Inexpensive to replace if lost
- Made in India

Code	Description	UOM	Price
K39636	Fixed Blade, Wooden Handle	EACH	£2.50

Twin Blade, Bergeon Swiss



Bergeon Swiss professional watchmakers case opener and knife combined. Precisely bevelled blade made by the famous "Swiss Army" knife manufacturer Wenger.

- Watch case opener & knife
- Thicker, chunkier handle for better grip
- Stainless steel, closable blades
- Length when closed 75mm
- Includes tweezers and oil pick
- Bergeon Swiss
- Bergeon 7403

Code	Description	UOM	Price
C48332	Twin Blade, Bergeon Swiss	EACH	£14.85

Twin Blade, Chinese



- Double blade case opener
- Stainless steel blades
- Metallic handle
- Overall length 170mm
- Handle length 85mm
- Made in China

Code	Description	UOM	Price
C37430	Twin Blade, Chinese	EACH	£8.50

Twin Blade, Victorinox Swiss



- New style Cousins Swiss case knife
- Thicker, chunky handle for better grip
- Swiss Made
- Cousins twin bladed case opener
- Combined 2 stainless steel blades
- Includes Swiss army style tweezers
- Includes toothpick
- Closed length 85mm

Code	Description	UOM	Price
K0890	Twin Blade, Victorinox Swiss	EACH	£13.75

Case Knives (Big Handles)

Big Handle - Snap On watch Case Backs

- Big handle
- More power during operation
- Plastic or metal handles
- Bergeon, Horotec or Chinese

Bergeon Swiss, Metal Handle (Left Handed)



- Big handle Ø22mm
- Anodised aluminium handle
- Stainless steel blade
- Left handed
- More power during operation
- Lightweight
- Snap on case back opener
- Bergeon 6987G

Code	Description	UOM	Price
C40302	Bergeon Swiss, Metal Handle (Left Handed)	EACH	£44.95

Bergeon Swiss, Metal Handle (Right Handed)



- Big handle Ø22mm
- Anodised aluminium handle
- Stainless steel blade
- Right handed
- More power during operation
- Lightweight
- Snap on case back opener
- Bergeon 6987

Code	Description	UOM	Price
C40303	Bergeon Swiss, Metal Handle (Right Handed)	EACH	£39.85

Bergeon Swiss Spare Blade (Left Handed)



- Spare Blade for Product Code C40302

Code	Description	UOM	Price
C40312	Bergeon Swiss Spare Blade (Left Handed)	EACH	£6.85

Bergeon Swiss Spare Blade (Right Handed)



- Spare Blade for Product Code C40303

Code	Description	UOM	Price
C40311	Bergeon Swiss Spare Blade (Right Handed)	EACH	£6.85

Chinese, Plastic Handle (Left Handed)

VALUE



- Big Handle, Ø20mm
- Overall length: 130mm
- More power during operation
- Lightweight
- Snap on case back opener
- Left handed blade
- Made in China

Code	Description	UOM	Price
C38062	Chinese, Plastic Handle (Left Handed)	EACH	£6.95



Chinese, Plastic Handle (Right Handed)

VALUE



- Big Handle, Ø20mm
- Overall length: 130mm
- More power during operation
- Lightweight
- Snap on case back opener
- Right handed blade
- Made in China

Code	Description	UOM	Price
C38061	Chinese, Plastic Handle (Right Handed)	EACH	£6.95

Chinese, Metal Handle (Right Handed)

VALUE



- Big Handle, Ø22mm
- Overall length: 140mm
- More Power During Operation
- Snap On Case Back Opener
- Made in China

Code	Description	UOM	Price
C38212	Chinese, Metal Handle (Right Handed)	EACH	£9.25

Horotec Swiss, Metal Handle (Right Handed)

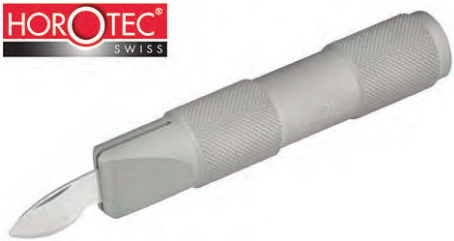

- Big handle
- More power during operation
- Lightweight
- Snap on case back opener
- Horotec 07.026

Code	Description	UOM	Price
C32258	Horotec Swiss, Metal Handle (Right Handed)	EACH	£27.95

Horotec Swiss Spare Blade



- Spare Blade for Product Code C32258
- 07.026B

Code	Description	UOM	Price
C32269	Horotec Swiss Spare Blade	EACH	£13.95

Hand Held Lever Case Openers

Case Back Opening Tools - Snap On Watch Case Backs - Hand Held

A selection of the most popular "hand held" snap on watch case back opening tools.

- Types:
- Knife blade
 - Lever
 - Microshock
 - Scoop

1 Lever, Bergeon Swiss



Case Back Opener with 1 Lever (Snap On Type)

- Bergeon 4755
- For "Snap On" back covers
- Front mounted blade
- Plastic handle
- Lever width 5mm
- Length: 130mm

Code	Description	UOM	Price
C52895	1 Lever, Bergeon Swiss	EACH	£20.95

2 Lever, Bergeon Swiss



Case Back Opener with 2 Levers (Snap On Type)

- Bergeon 6484
- For "Snap On" back covers
- Side mounted blade
- Green plastic handle
- Length: 140 mm

Code	Description	UOM	Price
C0307	2 Lever, Bergeon Swiss	EACH	£34.90

2 Lever, Non Swiss

VALUE



- For "Snap On" back covers
- Side mounted blade
- Green plastic handle
- Length: 140 mm

Code	Description	UOM	Price
C38059	2 Lever, Non Swiss	EACH	£6.95

Scoop Blade, A*F Swiss



Etic 350.155 - Swiss Made

An original tool with hollowed-out cylindrical blade in hardened steel. Uses a rolling motion to open snap-back watch cases.

- Length 130mm

Code	Description	UOM	Price
C0309	Scoop Blade, A*F Swiss	EACH	£19.70

Scoop Blade, Cousins Swiss Style



- For "Snap On" back covers
- Front mounted Scoop blade
- Green plastic handle
- Length: 130mm
- Made in India

Code	Description	UOM	Price
C38060	Scoop Blade, Cousins Swiss Style	EACH	£6.95

Scoop Blade, Non Swiss

VALUE



Non Swiss

A copy of the original tool with hollowed-out cylindrical blade in hardened steel. Uses a rolling motion to open snap-back watch cases.

- Length 130mm

Code	Description	UOM	Price
C36501	Scoop Blade, Non Swiss	EACH	£1.95

Seiko Style, Steel

VALUE



- Yellow plastic handle
- Steel blade

Code	Description	UOM	Price
C36349	Seiko Style, Steel	EACH	£1.95

Seiko Style, Stainless Steel

VALUE



- Orange plastic handle
- Stainless steel blade

Code	Description	UOM	Price
C20800	Seiko Style, Stainless Steel	EACH	£3.50

Seiko Style, Stainless Steel, Narrow Tip

VALUE



- Brown plastic handle with stainless steel narrow blade.
- 85 x 45mm
 - 28g

Code	Description	UOM	Price
C32766	Seiko Style, Stainless Steel, Narrow Tip	EACH	£8.95

Seiko Style, Stainless Steel, Set

VALUE



- Set of 4 Seiko style case openers
- Stainless steel blades
- Supplied in box

- Contains:
- Rounded tip, broad
 - Rounded tip, narrow
 - Square tip
 - Narrow tip

Code	Description	UOM	Price
C49426	Seiko Style, Stainless Steel, Set	PACK*4	£9.95

Seiko Style, Stainless Steel, Set Cousins

COUSINSUK



- Set of 4 Seiko style case openers
- Stainless steel blades
- Supplied in hinged plastic box

- Cousins

- Contains:
- Rounded tip, broad
 - Rounded tip, narrow
 - Square tip
 - Narrow tip

Code	Description	UOM	Price
C55416	Seiko Style, Stainless Steel, Set Cousins	PACK*4	£22.95

Seiko Style, Stainless Steel, Set Horotec Swiss

HOROTEC
SWISS



- Set of 4 Seiko style case openers
- Stainless steel blades
- Supplied in hinged plastic box
- Horotec 07.024

- Contains:
- Rounded tip, broad
 - Rounded tip, narrow
 - Square tip
 - Narrow tip

Code	Description	UOM	Price
C53349	Seiko Style, Stainless Steel, Set Horotec Swiss	PACK*4	£35.95

Micro-Shock Case Opener, Bergeon

BERGEON



- Bergeon 6929 - Swiss Made
- Supplied with 2 blades 3.00 & 4.50mm
 - Replacement blades available

Instructions for use:
Protect the bezel lip with masking tape. Select between the blades 3.00mm and 4.50 mm according to the bezel lip size. Set the watch, crystal side, on a microfibre cloth and keep it steady. Introduce the blade between the lip and the bezel and make a movement like a lever (from top to bottom). For back cases with high strain: The blade must facing the space, between the lip and the bezel. Protect the case by using masking tape under an angle of about 30 degrees, push the tool until the release click of retractable shaft until the stop of internal hammer.

After the micro-shock, the blade will be between the lip and the bezel and open the case-back. In some circumstances of very high strain, it's desirable to proceed by pushing the retractable shaft several times until the case back is open.

Function of stop knob: When pressing with your forefinger the steel knob on the tool, during the micro-shock release, limit the travel of retractable shaft. Impulse adjustment of microshock: To reduce the micro-shock impulse, unscrew the tool red back side and if necessary, to increase, screw the same part.

Code	Description	UOM	Price
C49601	Micro-shock Case Opener, Bergeon 6929	EACH	£149.95
C49602	3.00mm Spare Blade, Bergeon 6929.3	EACH	£19.95
C49603	4.50mm Spare Blade, Bergeon 6929.4.5	EACH	£19.95

Micro-Shock Case Opener, Horotec



Horotec 07.004 - Swiss Made

A case opener suitable for opening all cases with "snap-on" backs and for removing friction-fit case bezels. This fine quality tool, of robust construction can be used both as a simple opening lever or with a dual action as a punch, activated by an internal hammer. The strength of the choc (shock) is adjustable by screwing (+ power) or unscrewing (- power) the handle depending on the tightness of the case back.

- 3 shaped blades, Ø3.50, 4.50 & 5.00mm
- Hardened steel blades, polished to a mirror finish
- Replacement blade set available
- Swiss Made
- Horotec 07.004

Code	Description	UOM	Price
C0310	Micro-choc, Horotec Swiss	EACH	£66.95
C49368	Micro-choc Blade Set, Horotec Swiss	PACK*3	£21.50

CASE OPENING - SOWAR PRIMA

Sowar Prima Case Openers

COUSINSUK



- Sowar Prima case openers
- Set of 8 case openers
- Steel openers

Sizes:

- 18, 20, 23, 25, 27, 28, 29 & 32mm

Code	Description	UOM	Price
C47056	Sowar Prima Case Openers	PACK*8	£9.95

CASE OPENING - SUCTION GRIP

Suction Grip Bergeon

Bergeon 2533 - Swiss Made

- Rubber tipped Ø23mm
- Rubber opening key for opening and closing cases of waterproof watches
- Handy for starting threads
- Will not open very tight backs



Code	Description	UOM	Price
C0340	Suction Grip, Bergeon 2533	EACH	£14.75

Suction Grip, Far East

- Rubber tipped Ø23mm
- Rubber opening key for opening and closing cases of waterproof watches
- Handy for starting threads
- Will not open very tight backs



Code	Description	UOM	Price
C36467	Suction Grip, Far East	EACH	£2.25

Suction Grip Disc (Ø50mm)

VALUE



- Rubber opening key for opening and closing cases of waterproof watches
- Double Sided
- Suitable for Case Backs Up Ø50mm
- Very Simple & Easy to Use
- Handy for starting threads
- Will not open very tight backs

Code	Description	UOM	Price
C32059	Suction Grip Disc (Ø50mm)	EACH	£2.20

Suction Grip Ball, Ø60mm

COUSINSUK



- Ø60mm
- Suction/friction action case opener
- Handy for starting threads
- Will not open very tight case backs
- Colour may vary

Code	Description	UOM	Price
C44831	Suction Grip Ball, Ø60mm	EACH	£3.50

Suction Grip Ball, Ø65mm, Bergeon Swiss

BERGEON



- Ø65mm
- Suction/friction action case opener
- Handy for starting threads
- Will not open very tight case backs
- "8 ball" look
- With Bergeon logo
- Bergeon 8008

Code	Description	UOM	Price
C51738	Case Opener, Bergeon 8008	EACH	£3.85
Price breaks available, see website			



Suction Grip Dies with Holder, Cousins

COUSINSUK



Upper dies in aluminium fitted with synthetic rubber rings for opening screw back watch cases. Excellent grip for opening the tightest cases.

- Large black plastic, easy grip handle (Ø65mm)
- 10 suction dies: Ø15, 20, 22, 25, 30, 33, 40, 45, 50 & 55mm
- Dies easily interchangeable via screw lock
- Excellent tool and brilliant value

Universal Fitting Dies for Tools:

- Bergeon Swiss
- Horotec Swiss
- Swiss Style

Fitting:

- Universal = dies fit directly on to the tools

Code	Description	UOM	Price
C45609	Cousins Suction Dies and Handle	EACH	£65.85
C47919	Ø15mm Suction Die	EACH	£5.50
C47920	Ø20mm Suction Die	EACH	£5.50
C47921	Ø22mm Suction Die	EACH	£5.50
C47922	Ø25mm Suction Die	EACH	£6.75
C47923	Ø30mm Suction Die	EACH	£6.75
C47924	Ø33mm Suction Die	EACH	£6.75
C47925	Ø40mm Suction Die	EACH	£6.95
C47926	Ø45mm Suction Die	EACH	£7.50
C47927	Ø50mm Suction Die	EACH	£7.95
C47928	Ø55mm Suction Die	EACH	£8.50
C48844	Handle	EACH	£11.95

Suction Grip Dies, Hard



Bergeon 5700-62 Series (Adiprene)
Horotec 07.325 Series (Synthetic Blue)

Upper fitting hard adiprene suction dies in aluminium with increased adherence for opening/closing screw on case backs. Less flexible than the soft adiprene series it is a slightly deformable material that adapts to the case & case back shape. For optimal adherence, remove all traces of grease or dust on the synthetic material and case & case back, using a cloth stocked with an alcohol cleaning fluid.

Universal Fitting Dies for Tools:

- Bergeon Swiss
- Horotec Swiss
- Swiss Style

Fitting:

- Universal = dies fit directly on to the tools

Code	Description	UOM	Price
C47837	Ø16mm (Hard) Bergeon	EACH	£38.75
C47853	Ø16mm (Hard) Horotec	EACH	£20.45
C47838	Ø19mm (Hard) Bergeon	EACH	£38.75
C47854	Ø20mm (Hard) Horotec	EACH	£22.95

C47839	Ø22mm (Hard) Bergeon	EACH	£38.75
C47855	Ø23mm (Hard) Horotec	EACH	£22.95
C47840	Ø26mm (Hard) Bergeon	EACH	£38.75
C47856	Ø26mm (Hard) Horotec	EACH	£22.95
C47841	Ø30mm (Hard) Bergeon	EACH	£38.75
C47857	Ø30mm (Hard) Horotec	EACH	£30.95
C47842	Ø34mm (Hard) Bergeon	EACH	£38.75
C47858	Ø34mm (Hard) Horotec	EACH	£25.95
B33551	Ø40mm (Hard) Bergeon	EACH	£38.75
C47859	Ø40mm (Hard) Horotec	EACH	£30.95
B33552	Ø45mm (Hard) Bergeon	EACH	£38.75
C47860	Ø45mm (Hard) Horotec	EACH	£31.95
B33553	Ø50mm (Hard) Bergeon	EACH	£38.75

Suction Grip Dies, Soft



Bergeon 5700-52 Series (Adiprene)
Horotec 07.333 Series (Synthetic Red)

Upper fitting soft adiprene suction dies in aluminium with increased adherence for opening/closing screw on case backs. More flexible than the hard adiprene series it is a slightly deformable material that adapts to the case & case back shape. For optimal adherence, remove all traces of grease or dust on the synthetic material and case & case back, using a cloth stocked with an alcohol cleaning fluid.

Universal Fitting Dies for Tools:

- Bergeon Swiss
- Horotec Swiss
- Swiss Style

Fitting:

- Universal = dies fit directly on to the tools

Code	Description	UOM	Price
C47830	Ø16mm (Soft) Bergeon	EACH	£32.50
C47843	Ø16mm (Soft) Horotec	EACH	£32.50
C47831	Ø19mm (Soft) Bergeon	EACH	£32.50
C47844	Ø20mm (Soft) Horotec	EACH	£32.50
C47832	Ø22mm (Soft) Bergeon	EACH	£38.95
C47845	Ø23mm (Soft) Horotec	EACH	£32.50
C47833	Ø26mm (Soft) Bergeon	EACH	£38.95
C47846	Ø26mm (Soft) Horotec	EACH	£32.50
C47834	Ø30mm (Soft) Bergeon	EACH	£38.95
C47847	Ø30mm (Soft) Horotec	EACH	£32.50
C47835	Ø34mm (Soft) Bergeon	EACH	£38.95
C47848	Ø34mm (Soft) Horotec	EACH	£32.50
B33548	Ø40mm (Soft) Bergeon	EACH	£38.95
C47849	Ø40mm (Soft) Horotec	EACH	£32.50
B33549	Ø45mm (Soft) Bergeon	EACH	£38.95
C47850	Ø45mm (Soft) Horotec	EACH	£32.95
B33550	Ø50mm (Soft) Bergeon	EACH	£38.95
C47851	Ø50mm (Soft) Horotec	EACH	£45.50
C47852	Ø55mm (Soft) Horotec	EACH	£56.50

Suction Grip Dies, Sets

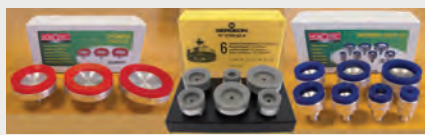

Bergeon Swiss Made (Adiprene)
Horotec Swiss Made (Synthetic Blue/Red)

Upper fitting suction dies in aluminium with increased adherence for opening/closing screw on case backs. Deformable material that adapts to the case & case back shape. For optimal adherence, remove all traces of grease or dust on the synthetic material and case back, using a cloth stocked with an alcohol cleaning fluid.

- Soft: More flexible than the hard adiprene series it is a deformable material that adapts to the case & case back shape
- Hard: Less flexible, it is a slightly deformable material that adapts to the case & case back shape

Universal Fitting Dies for Tools:

- Bergeon Swiss
- Horotec Swiss
- Swiss Style

Fitting:

- Universal = dies fit directly on to the tools

See website "more info" for further specification

Soft Suction, Bergeon 5700.52



Bergeon 5700-52
• Die set for gripping watch cases & case backs
• 9 dies: Ø16, 19, 22, 26, 30, 34, 40, 45 & 50mm
• Supplied with stand

Code	Description	UOM	Price
C47829	Soft Suction, Bergeon 5700.52	PACK*9	£259.95

Soft Suction, Horotec 07.333



Horotec 07.333
• Die set for gripping watch cases & case backs

- 7 dies: Ø16, 20, 23, 26, 30, 34 & 40mm

Code	Description	UOM	Price
C47870	Soft Suction, Horotec 07.333	PACK*7	£169.95

Soft Suction, Horotec 07.339



Horotec 07.339
• Die set for gripping watch cases & case backs
• 3 dies: Ø45, 50 & 55mm

Code	Description	UOM	Price
C47871	Soft Suction, Horotec 07.339	PACK*3	£115.00

Soft Suction, Horotec 07.343



Horotec 07.343
• Die set for gripping watch cases & case backs
• 10 dies: Ø16, 20, 23, 26, 30, 34, 40, 45, 50 & 55mm

Code	Description	UOM	Price
C47869	Soft Suction, Horotec 07.343	PACK*10	£264.95

Hard Suction, Bergeon 5700.62



Bergeon 5700-62
• Die set for gripping watch cases & case backs
• 9 dies: Ø16, 19, 22, 26, 30, 34, 40, 45 & 50mm
• Supplied with stand

Code	Description	UOM	Price
C47836	Hard Suction, Bergeon 5700.62	PACK*9	£259.95

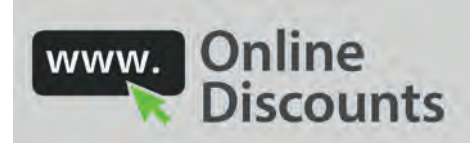

Hard Suction, Bergeon 5700-62-6



Bergeon 5700-62-6
 • Die set for gripping watch cases & case backs
 • 6 dies: Ø16, 19, 22, 26, 30 & 34mm
 • Supplied with wooden stand

Code	Description	UOM	Price
C0325	Hard Suction, Bergeon 5700-62-6	PACK*6	£173.95

Hard Suction, Horotec 07.325



Horotec 07.325
 • Die set for gripping watch cases & case backs
 • 7 dies: Ø16, 20, 23, 26, 30, 34 & 40mm

Code	Description	UOM	Price
C47872	Hard Suction, Horotec 07.325	PACK*7	£139.75

Suction Grip "Lower" Dies



Bergeon Swiss Made (Adiprene)

Lower fitting suction dies in aluminium with increased adherence for gripping & holding watch cases face down whilst unscrewing the case back. Deformable material that adapts to the front of the case shape. For optimal adherence, remove all traces of grease or dust on the synthetic material and case back, using a cloth stocked with an alcohol cleaning fluid.

Universal Fitting Dies for Tools:

- Bergeon Swiss
- Horotec Swiss
- Swiss Style

Fitting:

- Universal = dies fit directly on to the tools

Code	Description	UOM	Price
C0326	Soft Suction Lower Dies, Bergeon 5700.03	PACK*3	£114.95

C55056	Ø19mm Lower Suction Head, Bergeon 5700.0020	EACH	£44.95
C55057	Ø26mm Lower Suction Head, Bergeon 5700.0022	EACH	£44.95
C55058	Ø34mm Lower Suction Head, Bergeon 5700.0024	EACH	£44.95

CASE OPENING - TWIST ACTION (HAND HELD)

Hand Turn (up to 35mm) Slot Jaws, A*F Swiss



A*F Swiss 167.760

Popular case opener for screw back cases. Usable with the right or left hand thanks to the locking screw which fixes on either side. In blue anodised aluminium, sliding jaws in hard steel.

- Adjustable
- Blue anodised
- Aluminium body
- Steel jaws
- For right or left hand

Code	Description	UOM	Price
C0313	Hand Turn (up to 35mm) A*F Swiss	EACH	£49.95

Hand Turn (up to Ø50mm) Slot Jaws



- Screw back watch case opener
- Hardened precision ground tips mounted on fine tolerance threads
- Machined guides for rigidity
- Capacity 12 to 50mm
- Adjustable
- For right or left hand

Code	Description	UOM	Price
C8966	Hand Turn (up to Ø50mm)	EACH	£7.95



QUICKSHOP



BROWSE & BUY

Hand Turn (up to Ø65mm) Universal



Universal case opener with interchangeable bits suitable for watch cases with flats, slots, holes & oyster fittings.

- Screw back watch case opener
- Can accommodate cases up to Ø65mm
- Adjustable
- For right or left hand
- with Jaxa style bits (4 pairs)
- Bits can be filed and adapted to suit

Code	Description	UOM	Price
C37243	Hand Turn (up to Ø65mm)	EACH	£4.95

Hand Turn (up to Ø70mm) Round Jaws



- For big size cases
- Up to Ø70mm watch case
- With round jaws

Code	Description	UOM	Price
C42903	Hand Turn (up to Ø70mm) Round Jaws	EACH	£4.50

Hand Turn (up to Ø70mm) Slot Jaws



- For big size cases
- Up to Ø70mm watch case
- With slot jaws

Code	Description	UOM	Price
C32395	Hand Turn (up to Ø70mm) Slot Jaws	EACH	£3.95

WORLDWIDE DELIVERY



Online Discounts

Straight Double Arm, up to Ø54mm, Bergeon (Polygonal)



Bergeon 5338-XL-C Swiss Made

For waterproof polygonal cases the chucks are mobile and grip the case back perfectly, whether these are 6-8-10-12 or 14 sided. The reverse side of the wrench is used for holding other types of chucks. Maximum width 54mm

Contents:

- 1 Wrench
- 4 chucks for polygonal cases
- 2 chucks for cases with slots
- 2 chucks for cases with holes
- 2 chucks for oyster cases
- 2 chucks for aquastar cases
- 2 chucks for cases with curved sides

Code	Description	UOM	Price
C0317	Straight Double Arm, up to Ø54mm, Bergeon (Polygonal)	EACH	£149.95

Straight Double Arm, up to Ø65mm



- For big size cases
- From 38 mm to 65mm watch case
- 5 different key tips

Code	Description	UOM	Price
C20253	Straight Double Arm, up to Ø65mm	EACH	£11.25

Straight Single Arm, up to Ø55mm



- For big size cases
- Up to Ø55mm watch case
- Pin or Rectangular Tips
- Lever action movement

Code	Description	UOM	Price
C38064	Straight Single Arm, up to Ø55mm, Pin Tips	EACH	£7.95
C38063	Straight Single Arm, up to Ø55mm, Rectangle Tips	EACH	£6.95



T - Shape Lever Action, Cousins (Multi Tip)



- For big size cases
- Up to Ø55mm watch case
- 3 (x2) different key tips
- T - Shaped
- Made in far east

Code	Description	UOM	Price
C35128	Lever Action (Ø55mm) Opener, Multi Tip	EACH	£17.95

T - Shape Lever Action, Horotec



Horotec Lever Action

Slim design, easy to use on watches with integrated bracelets, ladies watches or with any case where work space is very narrow.

- Horotec 07.014
- Can open cases up to Ø57mm
- Overall length 155mm
- Supplied with elongated square case bits
- For additional case opening bits see tool C22162
- Made in Switzerland

Code	Description	UOM	Price
C41143	Lever Action	EACH	£54.95

CASE OPENING - UNIVERSAL, BERGEON

Offers Maximum Flexibility and Interchangeability with Dies.

The majority of case back dies we sell for our universal case back removing & fitting tools (Bergeon, Horotec & Swiss Style) are all interchangeable with each other.

- All Universal dies fit directly on to the tools
- All Universal with Adapter dies fit on to the tools using adaptor C0318 or C39846

Universal Case Back Tool, Bergeon 5700Z Swiss

Bergeon 5700z

Contents:

- Case Opening tool

- Adjustable jaw holder, maximum opening 60mm
- 6 pairs of pins (hardened steel)
- 4 pairs of case holding jaws

Specifications:

- Die cast, aluminium frame with white powder coating for extra protection
- Jaw holder for especially big cases (up to Ø60mm)
- Large ergonomic top wheel (Ø130mm) for extra easy case opening
- Fantastic range of additional accessories and dies
- Guaranteed to be forever relevant with a Bergeon forward thinking programme of manufacturing future requirements

Dimensions:

- Base: 250 x 95mm
- Height: 300mm
- Top wheel: Ø130mm

Offers Maximum Flexibility and Interchangeability with Dies.

The majority of case back dies we sell for our universal case back removing & fitting tools (Bergeon, Horotec & Swiss Style) are all interchangeable with each other.

- All Universal dies fit directly on to the tools
- All Universal with Adapter dies fit on to the tools using adaptor C0318 or C39846
- Lower fitting suction dies for gripping & holding watch cases face down whilst unscrewing the case back, see item C0326

Bergeon 5700Z Complete Tool (New Version)



Bergeon 5700z

Contents:

- Adjustable jaw holder, maximum opening 60mm
- 6 pairs of pins (hardened steel)
- 4 pairs of case holding jaws

Offers Maximum Flexibility and Interchangeability with Dies.

The majority of case back dies we sell for our universal case back removing & fitting tools (Bergeon, Horotec & Swiss Style) are all interchangeable with each other.

- All Universal dies fit directly on to the tools
- All Universal with Adapter dies fit on to the tools using adaptor C0318 or C39846

Code	Description	UOM	Price
C35045	Bergeon 5700Z Complete Tool (New Version)	EACH	£495.00

Big Diameter Case Adaptor, Bergeon 5700.04.G



- Vice Stake Holder for Extra Wide Cases
- Opening up to 60mm
- Already Included with 5700Z (C35045)
- Suitable for 5700 & 5700Z Case Opener

Code	Description	UOM	Price
C32172	Big Diameter Case Adaptor, Bergeon 5700.04.G	EACH	£134.95

Watch Case Holder, Bergeon 5674



- To be used with Bergeon 5700 Series
- Replacement Jaws C4350

Code	Description	UOM	Price
C0301	Watch Case Holder, Bergeon 5674	EACH	£48.50

Bergeon 5674D Watch Case Holder Jaw

- Replacement Jaw for tool Bergeon 5674 (C0301)
- Bergeon 5674D



Code	Description	UOM	Price
C4350	Bergeon 5674D Watch Case Holder Jaw	EACH	£3.95

Price breaks available, see website

CASE OPENING - UNIVERSAL, HOROTEC

Offers Maximum Flexibility and Interchangeability with Dies.

The majority of case back dies we sell for our universal case back removing & fitting tools (Bergeon, Horotec & Swiss Style) are all interchangeable with each other.

- All Universal dies fit directly on to the tools
- All Universal with Adapter dies fit on to the tools using adaptor C0318 or C39846

Universal Case Back Tool, Horotec Compact



Horotec 07.320

Contents:

- Adjustable jaw holder, maximum opening 65mm
- 4 pairs of jaws (round, flat, square, knurled)
- Watch holder with 4 concave dies (height 18mm, max opening 70mm)

Offers Maximum Flexibility and Interchangeability with Dies.

The majority of case back dies we sell for our universal case back removing & fitting tools (Bergeon, Horotec & Swiss Style) are all interchangeable with each other.

- All Universal dies fit directly on to the tools
- All Universal with Adapter dies fit on to the tools using adaptor C0318 or C39846

Code	Description	UOM	Price
C22162	Universal Case Back Tool, Horotec Compact	EACH	£218.95



Universal Case Back Tool, Horotec



Horotec 07.360

Horotec tool only, build your own set with the vast array of dies & bits available!

Horotec professional precision press. Heavy and robust, built in steel and aluminium. Equipped with removable and adjustable watch holder with 4 Delrin dies to hold the watch cases securely and horizontally. Excellent frontal, lateral or plunging view. Large ergonomic top wheel (Ø160mm) for ease of opening and closing screw on case backs

Contents:

- Adjustable jaw holder, maximum opening 65mm
- 4 pairs of jaws (round, flat, square, knurled)
- Watch holder with 4 concave dies (height 18mm, max opening 70mm)

Offers Maximum Flexibility and Interchangeability with Dies.

The majority of case back dies we sell for our universal case back removing & fitting tools (Bergeon, Horotec & Swiss Style) are all interchangeable with each other.

- All Universal dies fit directly on to the tools
- All Universal with Adapter dies fit on to the tools using adaptor C0318 or C39846

Code	Description	UOM	Price
C52688	Horotec "All Purpose" Tool	EACH	£430.00

Universal Case Back Tool, Horotec with Suction Dies



Horotec 07.361

Horotec tool with a complete set of suction dies.

Horotec professional precision press. Heavy and robust, built in steel and aluminium. Equipped with removable and adjustable watch holder with 4 Delrin dies to hold the watch cases securely and horizontally.

Watch Case Back Protection Labels

See Page 1282



Excellent frontal, lateral or plunging view. Large ergonomic top wheel (Ø160mm) for ease of opening and closing screw on case backs

Contents:

- Adjustable jaw holder, maximum opening 65mm
- 4 pairs of jaws (round, flat, square, knurled)
- Watch holder with 4 concave dies (height 18mm, max opening 70mm)
- 7 case back suction dies, Ø16 to 40mm

Offers Maximum Flexibility and Interchangeability with Dies.

The majority of case back dies we sell for our universal case back removing & fitting tools (Bergeon, Horotec & Swiss Style) are all interchangeable with each other.

- All Universal dies fit directly on to the tools
- All Universal with Adapter dies fit on to the tools using adaptor C0318 or C39846

Code	Description	UOM	Price
C44241	Horotec "All Purpose" Tool - Professional	EACH	£525.00

Universal Case Back Tool, Horotec with Suction, Rolex & Baume & Mercier Dies



Horotec 07.363

The tool for the complete professional. Horotec tool supplied with a complete set of suction dies, Rolex dies and Baume & Mercier dies.

Horotec professional precision press. Heavy and robust, built in steel and aluminium. Equipped with removable and adjustable watch holder with 4 Delrin dies to hold the watch cases securely and horizontally. Excellent frontal, lateral or plunging view. Large ergonomic top wheel (Ø160mm) for ease of opening and closing screw on case backs

Contents:

- Adjustable jaw holder, maximum opening 65mm
- 4 pairs of jaws (round, flat, square, knurled)
- Watch holder with 4 concave dies (height 18mm, max opening 70mm)
- 7 case back suction dies, Ø16 to 40mm
- 8 Rolex case back dies, Ø18.5 to 36.5mm
- 3 Baumer & Mercier case back dies, Ø25, 30 & 33mm
- Removable die holder tray

Offers Maximum Flexibility and Interchangeability with Dies.

The majority of case back dies we sell for our universal case back removing & fitting tools (Bergeon, Horotec & Swiss Style) are all interchangeable with each other.

- All Universal dies fit directly on to the tools

- All Universal with Adapter dies fit on to the tools using adaptor C0318 or C39846

Code	Description	UOM	Price
C52687	Horotec "All Purpose" Tool - Complete	EACH	£799.95

Universal Case Back Tool, Adjustable Jaw Holder



Horotec 07.344

- Adjustable Jaws Holder for Professional Precision Presses
- For Horotec 07.320, 07.360, 07.361, 07.363, 07.364, 07.365, 07.367, 07.368, 07.369
- Compatible with all jaws horotec 07.323-x
- Weight 225g
- Maximum opening 65mm

Code	Description	UOM	Price
C32774	Adjustable Jaw Holder (65mm), Horotec	EACH	£121.10

Universal Case Back Tool, Case Holding Pegs



Universal Case Back Tool - Case Holding Pegs

- Stacked or concave pegs
- Can be used with either tool C22612 or C44214
- Horotec Swiss

Dimensions:

- Peg delrin height (diameter at the top x diameter at the bottom), Horotec reference

Code	Description	UOM	Price
C38256	13.5mm (Ø9.20 x Ø12mm) Concave Peg, Horotec 07.322	EACH	£6.95
C47863	18mm (Ø9 x Ø12mm) Concave Peg, Horotec 07.360.B	EACH	£6.95
C47862	20mm (Ø10 x Ø14mm) Stacked Peg, Horotec 07.374.A	EACH	£12.50

Universal Case Back Tool, Suction Case Holder

Horotec 07.367.A

- Can be used with either tool C22612 or C44214
- Holds any shape case
- Diameter Ø62mm
- Horotec Swiss



Code	Description	UOM	Price
C44247	Ø62mm Case Holder, Suction	EACH	£175.45

Horotec Die Storage Rack



Horotec 07.370

- Holds 9 dies
- Removeable tray (fits to the Horotec tool)
- Can be used in conjunction with our tool Horotec C44241 (Horotec 07.361)
- Can also be used with Horotec tools 07.360, 07.362, 07.364 & 07.365
- Horotec Swiss

Code	Description	UOM	Price
C47861	Die Storage Rack, Horotec 07.370	EACH	£63.95

Horotec Hand Held Die Holder



Horotec Swiss 07.305

Will take all Universal dies that fit directly on to the tools.

- Bergeon Swiss
- Horotec Swiss
- Swiss Style

Fitting:

- Universal = dies fit directly on to the tools
- Universal with Adapter = dies fit on to the tools using adaptor C0318 or C39846

You can also fit other available individual dies (Baume & Mercier, Breitling, Citizen, Omega, Paneria, Rolex)

Code	Description	UOM	Price
M32675	Universal Die Holder, Horotec	EACH	£42.95



**CASE OPENING
- UNIVERSAL,
SWISS STYLE**

Universal Case Back Tool, Swiss Style



Swiss Style

Wooden base (250 x 100mm) and jaw holder especially created for big cases, opening up 60mm. Large ergonomic top wheel (Ø150mm) for ease of opening and closing on a die cast frame, total height 300mm.

Contents:

- Adjustable jaw holder, maximum opening 60mm
- 6 pairs of pins (hardened steel)
- 4 pairs of case holding jaws

Offers Maximum Flexibility and Interchangeability with Dies.

The majority of case back dies we sell for our universal case back removing & fitting tools (Bergeon, Horotec & Swiss Style) are all interchangeable with each other.

- All Universal dies fit directly on to the tools
- All Universal with Adapter dies fit on to the tools using adaptor C0318 or C39846
- Lower fitting suction dies for gripping & holding watch cases face down whilst unscrewing the case back, see item C0326

Code	Description	UOM	Price
C38205	Universal Case Back Tool, Swiss Style	EACH	£159.95
C50446	Adjustable Jaw Holder	EACH	£44.95

**CASE OPENING
- UNIVERSAL
ACCESSORIES
& FITTINGS**

Case Holding Jaws



Universal Case Back Opening Tool - Holding Jaws

Reversible case holding jaws, in synthetic material to protect watch cases.

Universal Fitting Case Opening jaws for Tools:

- Bergeon Swiss
- Horotec Swiss
- Swiss Style

Fitting:

- Universal = jaws fit directly on to the tools listed above

Code	Description	UOM	Price
C32290	9-11mm, Bergeon	EACH	£3.50
C47864	9-11mm, Horotec	EACH	£5.95
C47873	9-11mm, Swiss Style	EACH	£3.50
C32291	13-15mm, Bergeon	EACH	£3.50
C47865	13-15mm, Horotec	EACH	£5.95
C47874	13-15mm, Swiss Style	EACH	£3.50
C7050	17-19mm, Bergeon	EACH	£3.50
C47866	17-19mm, Horotec	EACH	£6.50
C47875	17-19mm, Swiss Style	EACH	£3.50
C0316A	20-22mm, Bergeon	EACH	£3.50
C47867	20-22mm, Horotec	EACH	£6.50
C47876	20-22mm, Swiss Style	EACH	£3.50

Case Holding Jaws, Style 2



Universal Case Back Opening Tool - Holding Jaws

Reversible case holding jaws, in synthetic material to protect watch cases.

Universal Fitting Case Opening jaws for Tools:

- Bergeon Swiss
- Horotec Swiss
- Swiss Style

Fitting:

- Universal = jaws fit directly on to the tools listed above

Code	Description	UOM	Price
C32281	Set of Jaws, Bergeon 5700RU	PACK*6	£71.85
C32277	9-11mm, Bergeon 5700R	EACH	£7.75
C32278	13-15mm, Bergeon 5700S	EACH	£7.95
C32279	17-19mm, Bergeon 5700T	EACH	£8.95
C32280	20-22mm, Bergeon 5700U	EACH	£8.95



Case Holding Jaws, Style 3



Universal Case Back Opening Tool - Holding Jaws

Reversible case holding jaws, in synthetic material to protect watch cases.

Universal Fitting Case Opening jaws for Tools:

- Bergeon Swiss
- Horotec Swiss
- Swiss Style

Fitting:

- Universal = jaws fit directly on to the tools listed above

Code	Description	UOM	Price
C32286	Set of Jaws, Bergeon 5700RU	PACK*8	£78.95
C32282	9-11mm, Bergeon 5700V	EACH	£8.95
C32283	13-15mm, Bergeon 5700W	EACH	£8.15
C32284	17-19mm, Bergeon 5700X	EACH	£9.30
C32285	Y Jaw (20-22mm) Bergeon 5700Y	EACH	£9.30

Case Opening Bits



Case Opening Tool Bits - Universal

Replacement tool bits for universal case opening tools

Universal Fitting Case Opening bits for Tools:

- Bergeon Swiss
- Horotec Swiss
- Swiss Style

Fitting:

- Universal = bits fit directly on to the tools listed above

Code	Description	UOM	Price
C0319	Slots (A), Bergeon	EACH	£7.50
C38254	Slots (A), Horotec	EACH	£8.95
T47005	Slots (A), Swiss Style	PACK*2	£5.95
C41759	Slots Elongated (B), Horotec	EACH	£10.95
C0320	Polygonal (C), Bergeon	EACH	£4.95
C38253	Polygonal (C), Horotec	EACH	£8.95
T47006	Polygonal (C), Swiss Style	PACK*2	£5.95
C38252	Holes (D), Horotec	EACH	£8.95
T47007	Holes (D), Swiss Style	PACK*2	£5.95
C47868	Holes Elongated (E), Horotec	EACH	£8.95
C0322	Grooved (F), Bergeon (Rolex Oyster Type)	EACH	£6.95
C38255	Grooved (F), Horotec	EACH	£8.50

T47009	Grooved (F), Swiss Style (Rolex Oyster Type)	PACK*2	£5.95
C0323	Curved Sides (G), Bergeon	EACH	£5.60
C0324	Aquastar (H), Bergeon	EACH	£6.00
C0321	Points (I), Bergeon	EACH	£5.25
T47008	Points (I), Swiss Style	PACK*2	£5.95

Universal Adaptor



Universal die adaptor for fitting our "Universal" tools:
 • Bergeon Swiss
 • Horotec Swiss
 • Swiss Style

The tools in the above categories accept all our "Universal" case back dies which fit directly on to the tools.

Dies that are described as "Universal with Adapter" fit on to the tools using these adaptors C0318 (Bergeon 5538T) or C39846 (Non Swiss)

Code	Description	UOM	Price
C0318	Rolex Oyster Adaptor, Bergeon 5538T	EACH	£31.50
C39846	Rolex Oyster Adaptor, Non Swiss	EACH	£19.95

Universal Adapter for Screw on Dies



Universal Case Back Opening Tool - Adapter for Screw on Dies - Horotec Swiss

Adapters to allow case opening tools & presses to take screw on dies. Use with all screw-on dies with a thread of 6mm.

Universal Fitting screw on die adapter for Tools:

- Bergeon Swiss
- Horotec Swiss
- Swiss Style

Fitting:

- Universal = Adapters fit directly on to the tools listed above

Horotec Swiss

- 07.373.A (D47901) Upper Die
- 07.373.B (D47902) Lower Die

Code	Description	UOM	Price
D47902	Lower Adapter for Screw On Dies	EACH	£18.45
D47901	Upper Adapter for Screw On Dies	EACH	£5.25

GLASS CLAW FITTING TOOL

Tools for removing unbreakable round & round & shaped watch glasses

Simple removal and re-fitting of front round & round & shaped fitting acrylic watch glasses.

The new glass is gripped and lifted from the platform with pre-depth leading edge for inserting into the bezel and releasing.

Round Glasses (Superior)

Tool for removing unbreakable round watch glasses

Simple removal and re-fitting of front fitting round, acrylic watch glasses.

The new glass is gripped and lifted from the platform with pre-depth leading edge for inserting into the bezel and releasing.

- Crystal lift with base
- Superior manufactured quality tool
- Smooth finished, high quality brass jaws, will not damage the glass
- Body made from pure aluminium
- Claw capacity: Ø10mm to Ø50mm
- Platform capacity: Ø10mm to Ø40mm
- Handle diameter Ø40mm
- Overall height 70mm
- Made in India

Code	Description	UOM	Price
G39723	Round Glass Tool	EACH	£13.95
G37924	Round Glass Tool Spring	EACH	£8.95



Round Glasses, Bergeon 4266

Model for simple removing and re-fitting of front fitting round unbreakable watch glasses.

The new glass is gripped and lifted from the platform with pre-depth leading edge for inserting into the bezel and releasing.

- Bergeon 4266
- Swiss made
- Crystal lift with base
- Claw capacity: Ø10mm to Ø45mm
- Platform capacity: Ø10mm to Ø45mm
- Handle diameter Ø40mm
- Overall height 75mm

Additional adapters available for specific shaped glasses. These metal rings are fitted with a rubber joint to allow lifting and fitting of Tonneau, Cushion & Oval shaped glasses.

Code	Description	UOM	Price
G0719	Round Glasses, Bergeon 4266	EACH	£45.95
G0716	Tonneau Shaped Adapter, Bergeon 4266.1	EACH	£13.50
G0717	Cushion Shaped Adapter, Bergeon 4266.2	EACH	£14.95
G0718	Oval Shaped Adapter, Bergeon 4266.3	EACH	£14.95
P22029	Platform for Standard Crystals, Bergeon 4266E	EACH	£10.75



Round & Shaped Glasses, Bergeon 6400



Model for removing unbreakable round & shaped watch glasses

- Bergeon 6400 Swiss Made
- Crystal Lift with Base
- Capacity: Ø10.0mm to Ø45.0mm

Code	Description	UOM	Price
G0720	Round & Shaped Glasses, Bergeon 6400	EACH	£62.95

Internal Gasket, Bergeon 4266 & 6400

- Bergeon 4266J
 - Ø20mm
- Inner compression ring, maintaining tension of jaws on tool 4266 (G0719) & 6400 (G0720)



Replacement ring. In rubber for tool No 6400. Instructions for replacing the ring
 " Unscrew completely the knurled black head screw.
 " Pull out block with claws.
 " Replace rubber ring.
 " Re-assemble the tool.

Code	Description	UOM	Price
G7346	Internal Gasket, Bergeon 4266 & 6400	EACH	£2.50

External Gasket, Bergeon 6400

- Bergeon 6400D
- External Ø45mm



Code	Description	UOM	Price
G0720A	External Gasket, Bergeon 6400	EACH	£7.85

GLASS REMOVING PUMP

Glass Removing Pump



- For removing unbreakable glasses from one piece watch cases
- Supplied with 5 heads: Ø0.80, 1.30, 1.50, 1.80 & 1.90mm
- 1 key for removing the half-stem with the crown

With the split crown and stem removed the pump is

applied to the case tube and as internal pressure builds the glass is forced out for access to movement.

Code	Description	UOM	Price
G52921	Glass Removing Pump	EACH	£54.95
G52930	Glass Pump Nozzle Set	PACK*5	£9.95

Glass Removing Pump, Bergeon 5011



- For removing unbreakable glasses from one piece watch cases
- Supplied with 3 heads: Ø1.60, 2.00 & 2.50mm
- 1 key for removing the half-stem with the crown
- Bergeon Swiss

With the split crown and stem removed the pump is applied to the case tube and as internal pressure builds the glass is forced out for access to movement.

Code	Description	UOM	Price
G0724	Glass Removing Pump, Bergeon 5011	EACH	£105.95
G0725	Ø1.60mm Glass Pump Nozzle	EACH	£4.50
G0726	Ø2.00mm Glass Pump Nozzle	EACH	£4.50
G0727	Ø2.50mm Glass Pump Nozzle	EACH	£4.50

PRESS & DIES, A*F SWISS

Screw Down Press, A*F Swiss



A*F 179.140 Swiss Made

Robust press for the easy closing of watch cases with snap-on backs. Ideal for use in retail watch shops and at the point of sale. Designed with non-technical staff in mind but equally useful to watchmakers.

Upper part of the tool is machined from steel and mounted on two heavy chrome plated pillars for maximum stability. The upper handle with three arms fits comfortably in the hand. To save time, the tool features a wide thread on the spindle for quick closing as well as a removable socket-type die holder to facilitate die changing. The aluminum base in an attractive blue anodised blue finish is stable enough to

be used free standing but can also be screwed to the work bench if desired.

Supplied with 8 dies in tough nylon:

- 4 Reversible upper dies : Ø16/18, 20/22, 24/26, 28/30
- 1 Single die: Ø14mm
- 3 lower dies with bevelled edges Ø20, 25, 30mm (for watches with flat or domed glasses)
- For convenience, all dies are clearly marked with the diameter
- For extra dies also see sets D38224 & D38985

Dimensions:

- 120 x 70 x 155mm
- Weight: 1.4Kg

Code	Description	UOM	Price
C0311	*"Maxi Press" A*F Swiss	EACH	£268.25
C0311E	Ø14mm Die	EACH	£12.95
C0311A	Ø16/18mm Die	EACH	£12.95
C0311B	Ø20/22mm Die	EACH	£12.95
C0311C	Ø24/26mm Die	EACH	£12.95
C0311D	Ø28/30mm Die	EACH	£12.95
C0311F	Ø20mm Die, Lower	EACH	£12.95
C0311G	Ø25mm Die, Lower	EACH	£12.95
C0311H	Ø30mm Die, Lower	EACH	£12.95

PRESS & DIES, BERGEON

Rack Press, Bergeon 6173



Bergeon 6173 - Swiss Made

Rack Press for multiple uses where additional precision is required when glass fitting and watch case back closing

Supplied:

- Base, Press, Rack & Lever
- 2 x Die Support Reduction Rings, Bergeon 6173R (D38258)
- Upper Die Support, Bergeon 6173.ST2 (G34451)
- Lower Die Support (21mm), Bergeon 5500-T21 (G19830)

Dimensions:

- Spindle: 20 mm
- Height of press: 200 mm
- Working height available max: 110 mm
- Base: 300 x 110 x 20 mm

Code	Description	UOM	Price
G0723	Glass Fitting & Case Closing Precision Press, Bergeon	EACH	£515.00
D38258	Reduction Ring, Bergeon 6173R	EACH	£22.25
G34451	Upper Die Support, Bergeon 6173.ST2	EACH	£3.65

Rack Press Micrometric Stop, Bergeon



For Attaching to and use with Bergeon Precision Press 6173 (G0723)

- Bergeon 6173B
- Micrometric stop for rack press
- Easy adaptation on the press No 6173
- Anodized aluminium
- Adjustment by micrometric screw in hardened and tempered steel
- Precision: 0.01 mm graduation.

Press Micrometric Stop Bergeon 6173B. Attaches to tool 6173 (G0763) to provide a positive measured control stop on downward pressure and avoid excess load.

Code	Description	UOM	Price
G4870	Rack Press Micrometric Stop, Bergeon	EACH	£259.95

Press & Die Set, Bergeon 5500A



- Bergeon 5500A (Comprehensive)
- For fitting unbreakable crystals with or without tension ring
- On wooden stand
- Dimensions - 370 x 150mm

Item Includes:

- 1 press, Bergeon No.5500
- 1 Universal lower stake, Bergeon No.5500-31
- 1 Support Bergeon No.5500-T28

- 9 Curved Basic Lower Dies in Black Plastic with Metal Centre.

Sizes (Diameter):
Ø12, 14, 16, 20, 24, 28, 32, 36, 40mm

- 12 Aluminium Bevelled Upper Reversible Dies.
- Sizes (Diameter):
Ø44/42, 40/38, 35/34, 33/32, 31/30, 29/28, 27/26mm
Ø25/24, 23/22, 21/20, 19/18, 17/15mm

- 9 Aluminium Flat Reversible Lower Dies.
- Sizes (Diameter):
Ø17/15, 19/18, 21/20, 23/22, 25/24mm

PRICE PROMISE  GUARANTEE

Ø27/26, 29/28, 31/30, 33/32mm

Code	Description	UOM	Price
G0721	Press & Die Set, Bergeon 5500A	EACH	£410.00

Press & Die Set, Bergeon 5500C



- Bergeon 5500C (Reduced)
- For fitting unbreakable crystals with tension ring
- On wooden stand
- Dimensions - 200 x 150mm

Item Includes:

- 1 press, Bergeon No.5500
- 1 Universal lower Die, Bergeon No.5500-31
- 9 Aluminium Dies

- 9 Aluminium Bevelled Upper Reversible Dies.

Sizes (Diameter):

Ø35/34, 33/32, 31/30, 29/28, 27/26mm

Ø25/24, 23/22, 21/20, 19/18mm

Code	Description	UOM	Price
G0722	Press & Die Set, Bergeon 5500C	EACH	£259.95

Dies Individual, Bergeon



Glass Fitting - Individual Dies - Bergeon

Replace or enhance your existing die set with individually available dies.

- Bergeon Swiss
- Bakelite Ø12mm to Ø40mm
- Aluminium Lower Ø12mm to Ø36mm
- Aluminium Upper Ø15mm to Ø48mm

Code	Description	UOM	Price
S34982	Ø12mm Bakelite Die	EACH	£6.95
S34983	Ø14mm Bakelite Die	EACH	£6.95
S34984	Ø16mm Bakelite Die	EACH	£6.95
S34985	Ø20mm Bakelite Die	EACH	£6.95
S34986	Ø24mm Bakelite Die	EACH	£6.95
S34987	Ø28mm Bakelite Die	EACH	£6.95
S34988	32mm Bakelite Die	EACH	£6.95
S34989	Ø36mm Bakelite Die	EACH	£6.95
S34990	Ø40mm Bakelite Die	EACH	£6.95
S35003	Lower Ø14/12mm Aluminium Die	EACH	£10.95
S35004	Lower Ø17/15mm Aluminium Die	EACH	£10.95
S35005	Lower Ø19/18mm Aluminium Die	EACH	£10.95
S35006	Lower Ø21/20mm Aluminium Die	EACH	£10.95
S35007	Lower Ø23/22mm Aluminium Die	EACH	£10.95

S35008	Lower Ø25/24mm Aluminium Die	EACH	£10.95
S35009	Lower Ø27/26mm Aluminium Die	EACH	£10.95
S35010	Lower Ø29/28mm Aluminium Die	EACH	£10.95
S35011	Lower Ø31/30mm Aluminium Die	EACH	£10.95
S35012	Lower Ø33/32mm Aluminium Die	EACH	£10.95
S35013	Lower Ø36/34mm Aluminium Die	EACH	£10.95
S34991	Upper Ø17/15mm Aluminium Die	EACH	£10.95
S34992	Upper Ø19/18mm Aluminium Die	EACH	£10.95
S34993	Upper Ø21/20mm Aluminium Die	EACH	£10.95
S34994	Upper Ø23/22mm Aluminium Die	EACH	£10.95
S34995	Upper Ø25/24mm Aluminium Die	EACH	£10.95
S34996	Upper Ø27/26mm Aluminium Die	EACH	£10.95
S34997	Upper Ø29/28mm Aluminium Die	EACH	£10.95
S34998	Upper Ø31/30mm Aluminium Die	EACH	£10.95
S34999	Upper Ø33/32mm Aluminium Die	EACH	£10.95
S35000	Upper Ø35/34mm Aluminium Die	EACH	£10.95
G7347	Upper Ø40/38mm Aluminium Die	EACH	£10.95
S35001	Upper Ø44/42mm Aluminium Die	EACH	£10.95
S35002	Upper Ø48/46mm Aluminium Die	EACH	£17.95

Die Set, Bergeon 5500.A1



Bergeon 5500.A1

- Assortment of 30 dies for fitting crystals
- Closes certain case backs
- To be used with presses G0721 (Bergeon No.5500) and G0723 (Bergeon No.6173)

Contains:

9 Curved Basic Lower Dies in Black Plastic with Metal Centre.

- Ø12, 14, 16, 20, 24, 28, 32, 36, 40mm

12 Aluminium Bevelled Upper Reversible Dies.

- Ø44/42, 40/38, 35/34, 33/32, 31/30, 29/28mm
- Ø27/26, 25/24, 23/22, 21/20, 19/18, 17/15mm

9 Aluminium Flat Reversible Lower Dies.

- Ø17/15, 19/18, 21/20, 23/22, 25/24mm
- Ø27/26, 29/28, 31/30, 33/32mm

1 Aluminium Universal Die for Cases with Large Horns or Bezel Claws

Code	Description	UOM	Price
G0721A	Die Set, Bergeon 5500.A1	EACH	£264.95

Bezel Dies



Bergeon 7499.A

- Assortment of 13 synthetic dies
- Brass core thread
- For fitting bezels
- Closes certain case backs
- To be used with presses G0721 (Bergeon No.5500) and G0723 (Bergeon No.6173)

Contains die sizes:

- Ø22/23, 24/25, 26/27, 28/29, 30/31, 32/33, 34/35, 36/37, 38/39, 40/41 42/43, 44/45 & 46/47mm

Code	Description	UOM	Price
D45951	Bezel Dies, Bergeon 7499.A	PACK*13	£174.95

Glass Dies for Domed Minerals



Bergeon 6527-6CP

- Assortment of 6 delrin (POM) dies, Thread M6
- Thickness 16mm
- For fitting domed mineral watch glasses
- Closes waterproof watch cases
- To be used with presses G0721 (Bergeon No.5500) and G0723 (Bergeon No.6173)

Die sizes (Diameter) -

- 19, 22, 26, 30, 35 & 40mm

Code	Description	UOM	Price
B34686	Glass Dies for Domed Minerals	PACK*6	£84.95
S34974	19mm Glass Fitting Die	EACH	£19.95
S34975	22mm Glass Fitting Die	EACH	£19.95
S34976	26mm Glass Fitting Die	EACH	£19.95
S34977	30mm Glass Fitting Die	EACH	£19.95
S34978	35mm Glass Fitting Die	EACH	£19.95
S34979	40mm Glass Fitting Die	EACH	£19.95

Glass Dies for Domed Minerals, Extra Large



Bergeon 6527-5CP-XL

- Assortment of 5 delrin (POM) dies, Thread M6
- Thickness 16mm
- For fitting extra large (XL) domed mineral watch glasses
- Closes waterproof watch cases
- To be used with presses G0721 (Bergeon No.5500) and G0723 (Bergeon No.6173)

Die sizes (Diameter) -

- 45, 50, 55, 60 & 65mm

Code	Description	UOM	Price
S34962	Glass Dies for Domed Minerals, Extra Large	PACK*5	£82.95

S34963	Glass Fitting Die, 45mm	EACH	£23.95
S34964	Glass Fitting Die, 45mm	EACH	£23.95
S34965	Glass Fitting Die, 55mm	EACH	£23.95
S34966	Glass Fitting Die, 60mm	EACH	£23.95
S34967	Glass Fitting Die, 65mm	EACH	£23.95

Glass Dies for Domed Minerals, Extra Large, Aluminum



Bergeon 5500-04-XL
 • Reversible Aluminum Stakes
 • Big Sizes

Die sizes (Diameter)-
 • Ø52 x 50mm, Ø56 x 54mm
 • Ø60 x 58mm, Ø64 x 62mm

Code	Description	UOM	Price
S35014	Glass Dies for Domed Minerals, Extra Large, Aluminum	PACK*4	£72.95
S35015	Ø52 x 50mm Glass Fitting Die	EACH	£20.95
S35016	Ø56 x 54mm Glass Fitting Die	EACH	£20.95
S35017	Ø60 x 58mm Glass Fitting Die	EACH	£20.95
S35018	Ø64 x 62mm Glass Fitting Die	EACH	£20.95

Glass Dies for Flat Minerals



Bergeon 6527-6P
 • Assortment of 6 delrin (POM) dies with metal core, Thread M6
 • Thickness 16 mm
 • For fitting flat mineral watch glasses
 • Closes waterproof watch cases
 • To be used with presses G0721 (Bergeon No.5500) and G0723 (Bergeon No.6173)

Die sizes (Diameter) -
 • 19, 22, 26, 30, 35 & 40mm

Code	Description	UOM	Price
D0422	Glass Dies for Flat Minerals	PACK*6	£79.95
S34968	19mm Glass Fitting Die	EACH	£16.95
S34969	22mm Glass Fitting Die	EACH	£16.95
S34970	26mm Glass Fitting Die	EACH	£16.95
S34971	30mm Glass Fitting Die	EACH	£16.95
S34972	35mm Glass Fitting Die	EACH	£17.95
S34973	40mm Glass Fitting Die	EACH	£17.95

Glass Dies for Flat Minerals, Extra Large



Bergeon 6527-5P-XL
 • Assortment of 5 delrin (POM) dies without metal core, Thread M6
 • Thickness 16 mm
 • For fitting extra large (XL) flat mineral watch glasses
 • Closes waterproof watch cases
 • To be used with presses G0721 (Bergeon No.5500) and G0723 (Bergeon No.6173)

Die Sizes (Diameter) -
 • 45, 50, 55, 60 & 65mm

Code	Description	UOM	Price
S34956	Glass Dies for Flat Minerals, Extra Large	PACK*5	£82.95
S34957	Glass Fitting Die, 45mm	EACH	£21.35
S34958	Glass Fitting Die, 55mm	EACH	£21.35
S34959	Glass Fitting Die, 45mm	EACH	£21.35
S34960	Glass Fitting Die, 60mm	EACH	£21.35
S34961	Glass Fitting Die, 65mm	EACH	£21.35

Glass Dies for Tension Rings



Bergeon 5499.08 (set of 8)
 Bergeon 5499.15 (set of 15)

• Assortment of 15 or 8 Aluminium Dies
 • For Fitting Divers Armoured Tension Ring Acrylic Glasses
 • Closes Certain Case Backs
 • To be used with presses G0721 (Bergeon No.5500) and G0723 (Bergeon No.6173)

Set of 8 contains:
 • Ø34.5/34, 33.5/33, 32.5/32, 31.5/31mm
 • Ø30.5/30, 29.5/29, 28.5/28, 27.5/27mm

Set of 15 contains:
 • Ø36.5/36, 35.5/35, 34.5/34, 33.5/33, 32.5/32, 31.5/31, 30.5/30mm
 • Ø29.5/29, 27.5/27, 26.5/26, 25.5/25, 24.5/24, 23.5/23, 22.5/22mm

Code	Description	UOM	Price
D0424	Glass Dies for Tension Rings, Bergeon 5499.15	PACK*15	£159.95
D28851	Glass Dies for Tension Rings, Bergeon 5499.08	PACK*8	£99.95

Supports (Die), Bergeon

Bergeon 5500-T05, T21 & T28

Lower die support for screw on dies with a thread diameter of 6mm. For Bergeon presses and rack press.

Dimensions

- Ø6mm Thread
- Ø10mm Fitting
- Raises die by 5, 21 & 28mm



For Bergeon Glass fitting and Case Closing Tools:

- Bergeon 5500A (G0721)
- Bergeon 5500C (G0722)
- Bergeon 6173 (G0723) (Requires reduction ring, code D38258)

Code	Description	UOM	Price
G19829	5mm Lower Die Support, Bergeon 5500-T05	EACH	£6.85
G19830	21mm Lower Die Support, Bergeon 5500-T21	EACH	£6.85
G19831	28mm Lower Die Support, Bergeon 5500-T28	EACH	£6.85

PRESS & DIES, SWISS STYLE

Dies all interchangeable & compatible with

- Bergeon Swiss
- Horotec Swiss
- Swiss Style

Press & Die Set, Swiss Style



- For fitting unbreakable crystals with or without tension ring
- With flat and recessed dies
- On wooden stand
- Dimensions - 350 x 150mm

Item Includes:

- 1 press
- 1 Universal lower stake
- 2 Supports

• 14 Aluminium Bevelled Upper Reversible Dies
 Sizes (Diameter):
 Ø44/42, 41/40, 39/38, 37/36, 35/34, 33/32, 31/30, 29/28mm
 Ø27/26, 25/24, 23/22, 21/20, 19/18, 17/15mm

• 10 Aluminium Flat Reversible Lower Dies.
 Sizes (Diameter):
 Ø12/10, 17/15, 19/18, 21/20, 23/22mm

Online Order Tracking

TRADE SUPPLIER

Online Discounts

Ø25/24, 27/26, 29/28, 31/30, 33/32mm

Code	Description	UOM	Price
P38213	Glass Fitting Press & Dies	EACH	£131.95

Case Closing Pliers

VALUE



- For closing snap on watch case backs or indeed watch glasses
- Rubber jaws to prevent scratching or marking
- Spring loaded
- Stainless steel
- Jaw diameter Ø40mm
- Overall length 200mm

Code	Description	UOM	Price
C39494	Watch Case Back Closing Pliers	EACH	£9.95

Lever Closing Press

Lever Closing Press

VALUE



Case Back & Glass Fitting Press - Hand Held Lever - With Dies

For fitting flat mineral glasses and case backs for quartz watch cases, with 12 push fit nylon dies, in popular diameters.

Die Diameters:

- Ø22 x 21mm, Ø25 x 24mm, Ø27 x 26mm
- Ø28 x 27mm, Ø28 x 29mm, Ø31 x 30mm
- Ø32 x 31mm, Ø33 x 32mm, Ø34 x 33mm
- Ø36 x 35mm, Ø37 x 36mm, Ø40 x 39mm

C19023 - Extra Large Round Dies
C19733 - Square Dies

Code	Description	UOM	Price
C6047	Lever Closing Press	EACH	£11.95

XL Die Set for Lever Closing Press



XL Dies for Press C6047

- Set of 6 extra large dies for C6047 case closing press
- Die sizes: 35, 40 & 45mm
- Double side dies 40/42.5mm, 45/47.5mm & 50/52.5mm
- Ideal for new larger type fashion watches

Code	Description	UOM	Price
C19023	XL Die Set for Lever Closing Press	PACK*8	£6.95

Square Die Set for Lever Closing Press

VALUE



Square Die Set for Press C6047

- Set Of 4 Square Dies
- For Tool C6047
- Sizes 25, 32, 38 and 45mm

Code	Description	UOM	Price
C19733	Square Die Set for Lever Closing Press	PACK*4	£7.95



Lever Closing Press (Heavy Duty)

Lever Closing Press (Heavy Duty)

VALUE



Case Back & Glass Fitting Press - Hand Held Lever - With Dies - Heavy Duty

For fitting flat mineral glasses and backs for quartz watch cases, with 24 nylon dies and spare black handle knob.

Dies included:

- 10 Round: Ø21 to Ø60mm
- 8 Round Flat: Ø24 to Ø52mm
- 6 Square/Rectangular: 16 to 30mm (inside)

Weight: 2.7Kg

Die set also available separately D37850

Code	Description	UOM	Price
C37835	Lever Closing Press (Heavy Duty)	EACH	£27.95

Die Set for Case & Glass Press, Heavy Duty

VALUE



Die Set for Press C37835

- For fitting flat and domed glasses
- 10 Round domed: Ø21 to Ø60mm
- 8 Round flat: Ø24 to Ø52mm
- 6 Square/Rectangular: 16 to 30mm (inside)

Code	Description	UOM	Price
D37850	Die Set for Case & Glass Press, Heavy Duty	PACK*24	£8.95

Arcylic Repair Polish

Polish out scratches in 2-3 minutes



See Page 1226





Screw Closing Press

Screw Closing Press

VALUE



Case Back Closing Press - Single Stage - With Dies

- Ideal case closer for awkward snap on backs
- Base 120 x 50mm
- Quick and easy fitting of backs
- Heavy, sturdy construction
- Fantastic Value
- Threaded top pin, non threaded bottom pin
- 5 Threaded nylon dies included, sizes from Ø14 to Ø30mm
- 3 Non threaded nylon dies included, sizes Ø20, Ø25 & Ø30mm
- For extra dies see set D38224 & D38985

Code	Description	UOM	Price
C38223	Screw Closing Press	EACH	£17.95

Die Set, Threaded & Non Threaded

VALUE



- 5 threaded dies, Ø14 to Ø30mm
- 3 Non threaded dies, Ø20, Ø25 & Ø30mm

Die set also available separately for tools C0311 & C38223

Code	Description	UOM	Price
D38985	Die Set, Threaded & Non Threaded	PACK*8	£6.95

Die Set, Threaded

VALUE



- 8 Threaded nylon dies, from Ø14 to Ø30mm
- For tools C0311 & C38223

Die set also available separately for tools C0311 & C38223

Code	Description	UOM	Price
D38224	Die Set, Threaded	PACK*8	£1.50

Screw Closing Press, with Even Pressure Spreading Disc

Screw Closing Press, with Even Pressure Spreading Disc

VALUE



Case Back Closing Press - Single Stage - Superior

- Includes an even pressure spreading disc, providing a greater surface area meaning that pressure is exerted more evenly on the dies and case back
- Provides the same pressure as a standard size press in half the bench space
- Superior quality
- Supplied as per picture including 12 delrin dies, Ø18 to Ø50mm
- Easy to transport and carry
- Ideal case closer for awkward snap on backs
- Quick and easy fitting of case backs
- Smooth, matt, high quality finish
- For Screw fixing dies
- Base 95 x 80 x 10mm
- Made in China

Code	Description	UOM	Price
C41040	Screw Closing Press, with Even Pressure Spreading Disc	EACH	£79.95

Pressure Disc for Case Back Tool

VALUE



An even pressure spreading disc, providing a greater surface area meaning that pressure is exerted more evenly on the dies and case back

Code	Description	UOM	Price
C44146	Pressure Disc for Case Back Tool	EACH	£15.95

Watch Case Back Protection Labels
See Page 1282



Screw Closing Press, with Even Pressure Spreading Disc (Heavy Duty)



Case Back Closing Press - Single Stage - Superior - Heavy Duty

- Includes an even pressure spreading disc, providing a greater surface area meaning that pressure is exerted more evenly on the dies and case back
- Exerts extra, more even pressure than any other similar sized press
- Superior quality
- Supplied as per picture including 16 delrin dies, Ø18 to Ø50mm
- Ideal case closer for awkward snap on backs
- Quick and easy fitting of case backs
- Smooth, matt, high quality finish
- For Screw fixing dies
- Supplied with flat and recessed dies
- For domed & flat watch glasses and case backs
- Spare pressure disc our code C41040
- Made in China

Dimensions:

- Base 115 x 110 x 10mm
- Overall height 200mm
- Handle diameter Ø80mm

Code	Description	UOM	Price
C50855	Screw Closing Press, with Even Pressure Spreading Disc (Heavy Duty)	EACH	£89.95

Screw Closing Press, Compact

VALUE



Case Back Closing Press - Single Stage - with Dies - Compact

- Ideal case closer for awkward snap on backs
- Base 80 x 60mm
- Quick and easy fitting of case backs
- Smooth, matt, high quality finish
- Rubber padded base
- Easy to transport and carry
- Great for small, tight working environments

- Fantastic value
- Non threaded bottom pin, top dies are push fit
- 12 delrin dies included
- Supplied with 6 recessed dies: Ø25, 30, 35, 37, 40 & 42mm
- Supplied with 6 flat dies: Ø25, 30, 35, 37, 40 & 42mm
- For domed & flat watch glasses and case backs
- Made in far east

Due to the economic value of the item the dies can sometimes come out of alignment. To correct this simply squeeze together the top and base at an angle, which will slightly bend the posts, correcting the tool. To make this action easier, the two hex screws at the top of the two posts can be loosened.

Code	Description	UOM	Price
C39642	Case Back Press, Compact	EACH	£16.50

Die Set (Universal), Aluminium



Case Back Closing Die Set - Universal - Set of 25 - Aluminium

- For domed and flat glasses
- Aluminium
- Set of 25 dies
- Can be used with any Horotec, A*F or Bergeon Swiss threaded die press (Including Bergeon 5500)
- Can also be used with our code C38223

Flat dies:

- Ø10/12, Ø15/17, Ø18/19, Ø20/21, Ø22/23
- Ø24/25, Ø26/27, Ø28/19, Ø30/31, Ø32/33, Ø35

Concave dies:

- Ø16/17, Ø18/19, Ø20/21, Ø22/23, Ø24/25
- Ø26/27, Ø28/29, Ø30/31, Ø32/33, Ø34/35
- Ø36/37, Ø38/39, Ø40/41, Ø43/44

Code	Description	UOM	Price
D55415	Case Back & Glass Closing Die Set	PACK*25	£27.15

Die Set (Universal), Nylon



Case Back Closing Die Set - Generic - Set of 16

- For domed and flat glasses
- Economy
- 16 nylon threaded dies sizes
- For tool C6047

- 6 flat dies: Ø20, 23, 25, 27, 30, & 35mm
- 10 double recessed dies (outer/inner size): Ø20.5/15.5, 23.5/ 21.5, 25.5/24.5, 27.5/26.5, 29/28, 31/30, 35/34, 39/37, 43/41 & 49/47mm (All sizes are approx)

Including metal die holder:

- Thread Ø6mm
- Base Ø12mm
- Overall length 30mm

Code	Description	UOM	Price
C20829	Case Back Closing Die Set	PACK*16	£11.95

Die Set (Universal), Nylon Superior Quality



Case Back Closing Die Set - Generic - Set of 24

- 17 round dies
- 6 square dies
- 1 base die
- Superior quality, made in Korea
- Supplied with flat and recessed dies
- For domed & flat watch glasses and case backs
- Supplied in sturdy storage and transportation case
- Can be used with any Horotec, A*F or Bergeon Swiss threaded die press (Including Bergeon 5500)
- Can also be used with our code C38223

Round reversible dies:

- Ø18/20, Ø22/24, Ø26/28, Ø30/32mm
- Ø34/36, Ø38/40, Ø42/44, Ø46/48mm

Round dies:

- Ø16, Ø27, Ø32, Ø35, Ø39mm
- Ø50, Ø53, Ø56, Ø59mm

Rectangular dies:

- 23.8, 28.8, 33.8, 38.8, 43.8, 48.8mm

Code	Description	UOM	Price
D40365	Case Back & Glass Closing Die Set	PACK*24	£95.00

PRESS & DIES, HOROTEC

Dies all interchangeable & compatible with

- Bergeon Swiss
- Horotec Swiss
- Swiss Style

Screw on die sets:

- Assorted dies, extra large (Horotec 07.107): D44220
- Bezel dies (Horotec 06.521): D44150
- Bezel dies, extra large (Horotec 06.525): D44187
- Case back dies (Horotec 07.106): D44206
- Case back dies, extra large (Horotec 07.108): D45412
- Case back dies, pyramidal (Horotec 06.511A): D44262
- Case back dies, pyramidal (Horotec 06.511B): D44261
- Case back dies, rectangular (Horotec 06.530): D44254
- Glass, domed, extra deep dies (Horotec 06.526): D44193
- Glass, flat mineral dies (Horotec 06.520): D44143

- Glass, flat mineral dies, extra large (Horotec 06.524): D44182
- Glass, flat mineral with date bubble dies (Horotec 06.520A): D45556
- Glass with tension ring, dies (Horotec 06.522): D44161
- Glass with tension ring, dies, extra large (Horotec 06.523): D44176
- Universal lower die (Horotec 07.106U): D45557

Push fit die sets:

- Bezel dies (Horotec 06.505): D44263
- Case back dies, pack*6, reduced set (Horotec 07.111): D44232
- Case back dies, pack*6, extra large (Horotec 07.113): D45570
- Case back dies, pack*13 (Horotec 07.116): D44233
- Glass, flat mineral dies, pack*6 (Horotec 07.112): D44322
- Glass, flat mineral dies, pack*10 (Horotec 06.510): D44221

Rack Press (Screw on Dies)



Horotec 06.150

This precision Rack-Press is provided with a small slide that allows to block or to free the toothed rack. The watchmaker thus has an exceptional tool for fitting glasses, bezels, closing watch cases and maintain the glass on the watch during joining time. Compatible with all Horotec screw-on dies

Free Toothed Rack (slide ahead)

For usual work on steel watch cases, thick or study. Apply pressure on the lever provided with an anti-skid rubber. The return spring and the fixed handle allow for careful adjustment of pressure upon use.

Blocked Toothed Rack (slide behind)

For delicate work on gold cases, thin or delicate. Pull the slide to lock the toothed rack in the desired position, then with each rotation the die goes down about 1.5mm. The fitting precision can be perfectly controlled.

Dimensions:

- Screw on dies, 6mm thread
- 80 x 215 x 185mm
- 2.70Kg

Code	Description	UOM	Price
C44242	Rack Press (Screw on Dies)	EACH	£335.00



Press (Screw On Dies) Compact



Horotec 07.105

The Horotec compact press is equipped with a direct threaded broach. Supplied with an assortment of 9 reversible screw-on dies (07.106) used to close snap-on case backs. Compatible with all Horotec screw-on dies.

- Screw on dies, 6mm thread
- Anodised aluminium pillars for stability
- Universal lower die for cases with large case horns or bezel claws (D45557)
- Maximum tool capacity Ø50mm die
- Swiss Made

Dies included:

- Ø17, 19/21, 22/25, 26/29, 30/33, 34/37, 38/41 & 42/45mm
- Universal lower die Ø45mm (D45557)

Code	Description	UOM	Price
C44246	Press (Screw On Dies) Compact	EACH	£119.95

Press (Screw On & Push Fit Dies)



Horotec 07.131

A compact press, suitable for all Horotec dies, even large diameters. The Horotec press is equipped with reversible die holders for fitting both screw-on & push fit dies. Supplied with an assortment of 12 reversible screw-on Delrin dies. Compatible with all Horotec screw-on and snap-on dies.

- Screw on dies, 6mm thread
- Snap-on upper dies Ø8mm fitting
- Snap-on lower dies Ø5mm fitting
- Universal lower die for cases with large case horns or bezel claws (D45557)
- Anodised aluminium pillars for stability
- Swiss Made

Dies included:

- Ø17, 19/21, 22/25, 26/29, 30/33, 34/37, 38/41, 42/45, 46/48, 49/50 & 52/55mm

- Universal lower die Ø45mm (D45557)

Dimensions:

- 110 x 95 x 210mm
- 1.2Kg

Code	Description	UOM	Price
C44240	Press (Screw On & Push Fit Dies)	EACH	£174.95

Lower Die Adapter, Horotec 07.130.B

Horotec 07.130.B - Swiss Made

- for tool 07.131 (C44240)



Code	Description	UOM	Price
D47906	Lower Die Adapter, Horotec 07.130.B	EACH	£7.65

Upper Die Adapter, Horotec 07.130.A

Horotec 07.130.A - Swiss Made

- for tool 07.131 (C44240)



Code	Description	UOM	Price
D47905	Upper Die Adapter, Horotec 07.130.A	EACH	£9.25

Press (Push Fit Dies)



Horotec 07.110

The Horotec compact press is equipped with a direct threaded broach. Supplied with an assortment of 6 reversible snap-on dies (07.111) used to close snap-on case backs. Compatible with all Horotec snap-on dies.

- Snap-on upper dies Ø8mm fitting
- Snap-on lower dies Ø5mm fitting
- Maximum tool capacity Ø50 mm die.
- Anodised aluminium pillars for stability
- Swiss Made

Dies included:

- Upper dies: Ø20/23, 26/29, 32/35mm
- Lower dies: Ø29, 35, 40mm

Dimensions:

- 80 x 60 x 130mm

- 580g

Code	Description	UOM	Price
C4675	Press (Push Fit Dies)	EACH	£69.50

Lower Die Support, Horotec 07.110A

Horotec 07.110-A - Swiss Made

- for tool 07.110 (C4675)



Code	Description	UOM	Price
D47903	Lower Die Support, Horotec 07.110A	EACH	£8.50

Lower Die Support Gasket, Horotec 07.110.J

Horotec 07.110-J - Swiss Made

- for lower die support 07.110.A (D47903)



Code	Description	UOM	Price
D47904	Lower Die Support Gasket, Horotec 07.110.J	EACH	£0.95

Assorted Dies (Screw On) Extra Large



Horotec 07.107

Set of 5, Special Large Diameters for Case Backs, Bezels & Flat Mineral Glasses. All dies compatible with all Horotec screw-on presses (plus also Bergeon & our Swiss Style Presses).

- Ø6mm thread
- Reinforced metal core to handle extreme pressure
- Delrin, strong non marking material
- Reversible dies

Set Contains

- 2 dies Ø40-45 & Ø46-50mm for fitting bezels
- 1 die Ø47-50mm for fitting flat mineral glasses
- 2 dies Ø46-48 & 49-50mm for fitting snap on case backs

Code	Description	UOM	Price
D44220	Assorted Dies (Screw On) Extra Large	PACK*5	£48.95



Bezel Dies (Push Fit)



Horotec 06.505

Set of 12 varying diameters snap-on dies for fitting bezels. Compatible with all Horotec screw on die presses.

- Upper dies have Ø8mm fitting hole
- Delrin, strong non marking material
- Pack*12
- Dies are reversible
- Horotec 06.505

Set Contains

- Ø23/22.5, 25/24, 27/26, 29/28, 31/30, 32.5/32, 33.5/33, 34.5/34, 35.5/35, 36.5/36, 37.5/37 & 38.5/38mm

Code	Description	UOM	Price
D44263	Bezel Dies (Push Fit)	PACK*12	£68.95
D44275	Ø23/22.5mm Die	EACH	£7.75
D44274	Ø25/24mm Die	EACH	£7.75
D44273	Ø27.5/26mm Die	EACH	£7.75
D44272	Ø29/28mm Die	EACH	£7.75
D44271	Ø31/30mm Die	EACH	£7.75
D44270	Ø32.5/32mm Die	EACH	£7.75
D44269	Ø33.5/33mm Die	EACH	£7.75
D44268	Ø34.5/34mm Die	EACH	£7.75
D44267	Ø35.5/35mm Die	EACH	£7.75
D44266	Ø36.5/36mm Die	EACH	£7.75
D44265	Ø37.5/37mm Die	EACH	£7.75
D44264	Ø38.5/38mm Die	EACH	£7.75

Bezel Dies (Screw On)



Horotec 06.521 (set of 11)

Horotec 06.525 (set of 5) extra large

Set of 5 & 11, varying diameters including extra large dies for fitting watch bezels. All dies compatible with all Horotec screw-on presses (plus also Bergeon & our Swiss Style Presses).

- Ø6mm thread
- Reinforced metal core to handle extreme pressure
- Delrin, strong non marking material
- Reversible dies
- Universal lower die for cases with large case horns or bezel claws (D45557)

Set of 11 Contains

- Ø25/26, 27/28, 29/30, 31/32, 33/33.5, 34/34.5, 35/35.5, 36/36.5, 37/37.5 & 38/38.5mm
- Universal lower die Ø45mm (D45557)

Set of 5 Contains:

- Ø40/45, 46/50, 52/55, 57/60 & 62/65mm

Code	Description	UOM	Price
D44150	Bezel Dies (Screw On)	PACK*11	£93.95
D44187	Bezel Dies (Screw On) Extra Large	PACK*5	£54.75
D44151	Ø25/26mm Die	EACH	£10.95
D44152	Ø27/28mm Die	EACH	£10.95
D44153	Ø29/30mm Die	EACH	£10.95
D44154	Ø31/32mm Die	EACH	£10.95
D44155	Ø33/33.5mm Die	EACH	£10.95
D44156	Ø34/34.5mm Die	EACH	£10.95
D44157	Ø35/35.5mm Die	EACH	£10.95
D44158	Ø36/36.54mm Die	EACH	£12.95
D44159	Ø37/37.5mm Die	EACH	£12.95
D44160	Ø38/38.5mm Die	EACH	£12.95
D44188	Ø40/45mm Die	EACH	£12.95
D44189	Ø46/50mm Die	EACH	£13.75
D44190	Ø52/55mm Die	EACH	£14.50
D44191	Ø57/60mm Die	EACH	£14.50
D44192	Ø62/65mm Die	EACH	£14.50

Case Back Dies (Push Fit)



Horotec 07.111 (set of 6) reduced set

Horotec 07.113 (set of 6) extra large

Horotec 07.116 (set of 13)

Set of either 6 or 13 dies with varying diameters for snap-on case backs. Compatible with all Horotec snap-on presses.

- Upper die fitting Ø8mm
- Lower die fitting Ø5mm
- Delrin, strong non marking material
- Reversible upper dies

Set of 6 (reduced set) includes:

- Upper dies: Ø52/55, 57/60, 62/65mm
- Lower dies: Ø55, 60, 65mm

Set of 6 (extra large set) includes:

- Upper dies: Ø20/23, 26/29, 32/35mm
- Lower dies: Ø29, 35, 39mm

Set of 13 includes:

- Upper dies: Ø20/23, 26/29, 32/35, 36/38, 39/41, 42/44, 45/47, 48/50mm
- Lower dies: Ø29, 35, 40, 45 & 50mm

Code	Description	UOM	Price
D44232	Case Back Dies (Push Fit) Reduced Set	PACK*6	£33.95
D45570	Case Back Dies (Push Fit), Extra Large	PACK*6	£45.95
D44233	Case Back Dies (Push Fit)	PACK*13	£89.95
D44234	Lower Ø29mm Die	EACH	£6.50
D44235	Lower Ø35mm Die	EACH	£6.50
D44237	Lower Ø40mm Die	EACH	£7.95
D44238	Lower Ø45mm Die	EACH	£9.50
D44239	Lower Ø50mm Die	EACH	£9.50
D44240	Lower Ø55mm Die	EACH	£11.25
D44241	Lower Ø60mm Die	EACH	£11.25
D44242	Lower Ø65mm Die	EACH	£11.25
D44243	Upper Ø20/23mm Die	EACH	£7.95

D44244	Upper Ø26/29mm Die	EACH	£7.95
D44245	Upper Ø32/35mm Die	EACH	£7.95
D44246	Upper Ø36/38mm Die	EACH	£8.95
D44247	Upper Ø39/41mm Die	EACH	£9.75
D44248	Upper Ø42/44mm Die	EACH	£10.75
D44249	Upper Ø45/47mm Die	EACH	£11.50
D44250	Upper Ø48/50mm Die	EACH	£11.50
D44251	Upper Ø52/55mm Die	EACH	£11.50
D44252	Upper Ø57/60mm Die	EACH	£11.50
D44253	Upper Ø62/65mm Die	EACH	£11.50

Case Back Dies (Screw On)



Horotec 07.106 (set of 9)

Horotec 07.108 (set of 5) extra large

Set of 5 or 9, varying diameters including extra large dies for snap-on case backs. All dies compatible with all Horotec screw-on presses (plus also Bergeon & our Swiss Style Presses).

- Ø6mm thread
- Reinforced metal core to handle extreme pressure
- Delrin, strong non marking material
- Reversible dies
- Universal lower die for cases with large case horns or bezel claws (D45557)

Set of 9 Contains:

- Ø17, 19/21, 22/25, 26/29, 30/33, 34/37, 38/41 & 42/45mm
- Universal lower die Ø45mm (D45557)

Set of 5 Contains:

- Ø46/48, 49/50, 52/55, 57/60 & 62/65mm

Code	Description	UOM	Price
D44206	Case Back Dies (Screw On)	PACK*9	£69.95
D45412	Case Back Dies (Screw On) Extra Large	PACK*5	£51.50
D44207	Ø17mm Die	EACH	£9.85
D44208	Ø19/21mm Die	EACH	£9.85
D44209	Ø22/25mm Die	EACH	£9.85
D44210	Ø26/29mm Die	EACH	£9.85
D44211	Ø30/33mm Die	EACH	£9.85
D44212	Ø34/37mm Die	EACH	£9.85
D44213	Ø38/41mm Die	EACH	£9.85
D44214	Ø42/45mm Die	EACH	£9.85
D44215	Ø46/48mm Die	EACH	£9.85
D44216	Ø49/50mm Die	EACH	£9.85
D44217	Ø52/55mm Die	EACH	£9.85
D44218	Ø57/60mm Die	EACH	£9.85
D44219	Ø62/65mm Die	EACH	£9.85

SECURE ONLINE ORDERING

OVER 130,000 DIFFERENT ITEMS

Case Back Dies (Screw On) Pyramidal



Horotec 06.511.A (gents/medium)
Horotec 06.511.B (ladies)

Two sizes of pyramidal dies. The die is placed on the base of the press and the watch glass comes above upside down to close the snap-on case back without damaging the pyramidal glass. All dies compatible with all Horotec screw-on presses (plus also Bergeon & our Swiss Style Presses).

- Ø6mm thread
- Reinforced metal core to handle extreme pressure
- Delrin, strong non marking material

Dimensions;

- Gents/medium 45 x 37mm (Depth 11mm)
- Ladies 37 x 30mm (Depth 9mm)

Code	Description	UOM	Price
D44262	37 x 30mm Pyramidal Die, Ladies	EACH	£41.95
D44261	45 x 37mm Pyramidal Die, Gents/ Medium	EACH	£43.95

Case Back Dies (Screw On) Rectangular

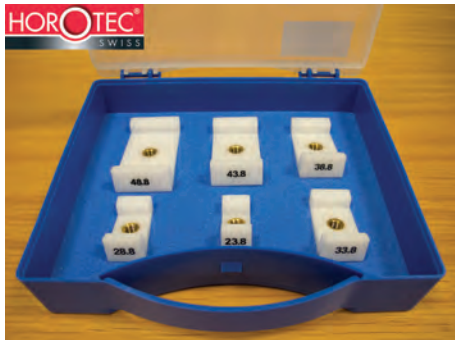

Horotec 06.530

Set of 6, varying size rectangular dies for fitting snap-on case backs or rectangular glasses. All dies compatible with all Horotec screw-on presses (plus also Bergeon & our Swiss Style Presses).

- Ø6mm thread
- Reinforced metal core to handle extreme pressure
- Delrin, strong non marking material

Dimensions: Length Ext. x Length Int. x (width x height)

- 24 x 13 x (13 x 13mm)
- 29 x 18 x (16 x 13mm)
- 34 x 23 x (19 x 13mm)
- 39 x 28 x (22 x 13mm)
- 44 x 33 x (25 x 13mm)
- 49 x 38 x (28 x 13mm)

Wall is 5.5mm thick with a 105 degree inner slopping chamfer

Code	Description	UOM	Price
D44254	Case Back Dies (Screw On) Rectangular	PACK*6	£34.75
D44255	24 x 13 x (13 x 13mm) Die	EACH	£8.95
D44256	29 x 18 x (16 x 13mm) Die	EACH	£8.95
D44257	34 x 23 x (19 x 13mm) Die	EACH	£8.95
D44258	39 x 28 x (22 x 13mm) Die	EACH	£8.95
D44259	44 x 33 x (25 x 13mm) Die	EACH	£8.95
D44260	49 x 38 x (28 x 13mm) Die	EACH	£8.95

Glass Dies (Push Fit) for Flat Minerals

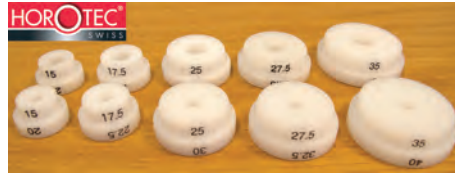

Horotec 06.510 (set of 10)
Horotec 07.112 (set of 6)

Set of either 6 or 10 snap-on dies with varying diameters for fitting flat mineral glasses. Compatible with all Horotec snap-on presses.

- Upper die fitting Ø8mm
- Lower die fitting Ø5mm
- Delrin, strong non marking material
- Reversible dies

07.112 Set of 6 includes:

- Upper dies: Ø20/15, 30/25, 40/35mm
- Lower dies: Ø20/15, 30/25, 40/35mm

06.510 Set of 10 includes:

- Upper dies: Ø20/15, 22.5/17.5, 30/25, 32.5/27.5, 40/35mm
- Lower dies: Ø20/15, 22.5/17.5, 30/25, 32.5/27.5, 40/35mm

Code	Description	UOM	Price
D44221	Glass Dies (Push Fit) for Flat Minerals	PACK*10	£49.95
D44322	Glass Dies (Push Fit) for Flat Minerals, Reduced Set	PACK*6	£27.95
D44227	Lower Die Ø15/20mm	EACH	£6.50
D44228	Lower Die Ø17.5/22.5mm	EACH	£6.50
D44229	Lower Die Ø25/30mm	EACH	£6.50
D44230	Lower Die Ø27.5/32.5mm	EACH	£6.50
D44231	Lower Die Ø35/40mm	EACH	£6.50
D44222	Upper Die Ø15/20mm	EACH	£6.50
D44223	Upper Die Ø17.5/22.5mm	EACH	£6.50
D44224	Upper Die Ø25/30mm	EACH	£6.50
D44225	Upper Die Ø27.5/32.5mm	EACH	£6.50
D44226	Upper Die Ø35/40mm	EACH	£6.50

Glass Dies (Screw On) for Flat Minerals



Horotec 06.520 (set of 8)
Horotec 06.524 (set of 4) extra large

Set of 4 or 8, varying diameters including extra large dies for fitting flat mineral watch glasses. All dies compatible with all Horotec screw-on presses (plus also Bergeon & our Swiss Style Presses).

- Ø6mm thread
- Reinforced metal core to handle extreme pressure
- Delrin, strong non marking material
- Reversible dies
- Universal lower die for cases with large case horns or bezel claws (D45557)

Set of 8 Contains:

- Ø16, 17/22, 23/28, 29/34, 35/40, 41/46mm
- Ø35mm die for glasses with date bubble
- Universal lower die Ø45mm (D45557)

Set of 4 Contains;

- Ø47/50, 52/55, 57/60 & 62/65mm

Code	Description	UOM	Price
D44143	Glass Dies (Screw On) for Flat Minerals	PACK*8	£67.95
D44182	Glass Dies (Screw On) for Flat Minerals, Extra Large	PACK*4	£41.95
D44144	Ø16mm Die	EACH	£12.25
D44145	Ø17/22mm Die	EACH	£12.25
D44146	Ø23/28mm Die	EACH	£12.25
D44147	Ø29/34mm Die	EACH	£12.25
D44148	Ø35/40mm Die	EACH	£12.25
D44149	Ø41/46mm Die	EACH	£12.25
D44183	Ø47/50mm Die	EACH	£13.65
D44184	Ø52/55mm Die	EACH	£13.65
D44185	Ø57/60mm Die	EACH	£13.65
D44186	Ø62/65mm Die	EACH	£13.65

Glass Dies (Screw On) for Flat Minerals with Date Lens

Horotec 06.520-A

Individual die for fitting flat mineral watch glasses with a date bubble. All dies compatible with all Horotec screw-on presses (plus also Bergeon & our Swiss Style Presses).

- Ø6mm thread
- Reinforced metal core to handle extreme pressure
- Delrin, strong non marking material

Set Contains

- Ø35mm with cut out

Code	Description	UOM	Price
D45556	Glass Dies (Screw On) for Flat Minerals with Date Lens	EACH	£11.25

Glass Dies (Screw On) for Domed, Extra Deep



Horotec 06.526

Set of 12, varying diameter dies for fitting very domed, deep watch glasses. All dies compatible with all Horotec screw-on presses (plus also Bergeon & our Swiss Style Presses).

- Ø6mm thread
- Reinforced metal core to handle extreme pressure
- Delrin, strong non marking material
- Extra deep, 14mm deep groove at a 45 degree angle

Set Contains

- Ø18, 20, 24, 28, 30, 35, 40, 45, 50, 55, 60 & 65mm

Code	Description	UOM	Price
D44193	Glass Dies (Screw On) for Domed, Extra Deep	PACK*12	£114.75

D44194	Ø18mm Die	EACH	£10.95
D44195	Ø20mm Die	EACH	£10.95
D44196	Ø24mm Die	EACH	£10.95
D44197	Ø28mm Die	EACH	£10.95
D44198	Ø30mm Die	EACH	£10.95
D44199	Ø35mm Die	EACH	£10.95
D44200	Ø40mm Die	EACH	£14.25
D44201	Ø45mm Die	EACH	£14.25
D44202	Ø50mm Die	EACH	£14.95
D44203	Ø55mm Die	EACH	£15.95
D44204	Ø60mm Die	EACH	£15.95
D44205	Ø65mm Die	EACH	£15.95

Glass Dies (Screw On) with Tension Rings



Horotec 06.522 (set of 15)
Horotec 06.523 (set of 5) extra large

Set of 15, varying diameters including extra large dies for fitting tension ring watch glasses. All dies compatible with all Horotec screw-on presses (plus also Bergeon & our Swiss Style Presses).

- Ø6mm thread
- Reinforced metal core to handle extreme pressure
- Delrin, strong non marking material
- Reversible dies
- Universal lower die for cases with large case horns or bezel claws (D45557)

Set of 15 Contains:

- Ø15, 16/17, 18/19, 20/21, 22/23, 24/25, 26/27, 28/29, 30/31, 32/33, 34/35, 36/37, 38/39, 40/41mm
- Universal lower die Ø45mm (D45557)

Set of 5 Contains:

- Ø42/45, 47/50, 52/55, 57/60 & 62/65mm

Code	Description	UOM	Price
D44161	Glass Dies (Screw On) with Tension Rings	PACK*15	£123.95
D44176	Glass Dies (Screw On) with Tension Rings, Extra Large	PACK*5	£39.95
D44162	Ø15mm Die	EACH	£9.95
D44163	Ø16/17mm Die	EACH	£9.95
D44164	Ø18/19mm Die	EACH	£9.95
D44165	Ø20/21mm Die	EACH	£9.95
D44166	Ø22/23mm Die	EACH	£9.95
D44167	Ø24/25mm Die	EACH	£9.95
D44168	Ø26/27mm Die	EACH	£9.95
D44169	Ø28/29mm Die	EACH	£9.95
D44170	Ø30/31mm Die	EACH	£9.95
D44171	Ø32/33mm Die	EACH	£9.95
D44172	Ø34/35mm Die	EACH	£9.95
D44173	Ø36/37mm Die	EACH	£9.95
D44174	Ø38/39mm Die	EACH	£9.95
D44175	Ø40/41mm Die	EACH	£9.95
D44177	Ø42/45mm Die	EACH	£9.95
D44178	Ø47/50mm Die	EACH	£9.95
D44179	Ø52/55mm Die	EACH	£9.95
D44180	Ø57/60mm Die	EACH	£9.95
D44181	Ø62/65mm Die	EACH	£9.95

Universal Lower Die (Screw On) for Cases with Large Case Horns

Horotec 07.106-U

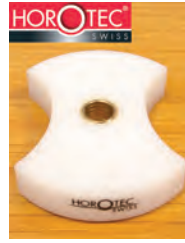

Individual universal lower die for cases with large case horns or bezel claws. All dies compatible with all Horotec screw-on presses (plus also Bergeon & our Swiss Style Presses).

- Ø6mm thread
- Reinforced metal core to handle extreme pressure
- Delrin, strong non marking material

Set Contains

- Ø45mm with cut out

Code	Description	UOM	Price
D45557	Universal Lower Die, Horotec Swiss	EACH	£11.95

PRESS & DIES, ROBUR

Press, Robur



Robur Case & Glass Press

Long standing & popular press for fitting watch glasses and snap on watch case backs.

- Robur France
- Very Popular
- High Quality
- Frame with threaded vertical shaft
- For use with Die Set Robur T31 (D0425)

Code	Description	UOM	Price
G0728	Robur Case & Glass Press	EACH	£159.95
G22246	Centre Shaft, Robur Press	EACH	£58.95
D22160	Retaining Spring for the Upper Die Holder	EACH	£10.50

Robur Comprehensive Die Set



• Robur T31

- Very Popular
- High Quality
- Comprehensive size coverage
- 21 metal dies
- 10 acrylic dies
- Hinged wooden case
- Size: 220 x 325 x 45mm

Code	Description	UOM	Price
D0425	Robur Comprehensive Die Set	PACK*31	£274.95

Dies Individual, Robur

Robur Case & Glass Press Individual Dies



- Individual concave dies
- Acrylic / bakelite Dies
- Numbered with equivalent aluminium letter
- 'Self Hold' in Robur tool G0728

Glass Ø range for each die:

- A = Ø10.0 to Ø11.5mm
- B = Ø11.6 to Ø13.0mm
- C = Ø13.1 to Ø14.0mm
- D = Ø14.1 to Ø15.0mm
- E = Ø15.1 to Ø16.5mm
- F = Ø16.6 to Ø18.0mm
- G = Ø18.1 to Ø19.5mm
- H = Ø19.6 to Ø21.0mm
- K = Ø21.1 to Ø22.5mm
- L = Ø22.6 to Ø24.5mm
- M = Ø24.6 to Ø26.5mm
- N = Ø26.6 to Ø28.5mm
- O = Ø28.6 to Ø30.5mm
- P = Ø30.6 to Ø32.5mm
- R = Ø32.6 to Ø34.5mm
- S = Ø34.6 to Ø37.5mm
- T = Ø37.6 to Ø41.5mm
- U & V = Ø41.6 to Ø45.5mm
- X = Ø45.6 to Ø49.5mm
- No.9 = 19.5mm outside die diameter
- No.21 = 51mm outside die diameter
- No.22 = 53mm outside die diameter
- No.23 = 56mm outside die diameter

Code	Description	UOM	Price
D042501	No.1 (A) Robur Die	EACH	£23.50
D042502	No.2 (B) Robur Die	EACH	£23.50
D042503	No.3 (C) Robur Die	EACH	£23.50
D042504	No.4 (D) Robur Die	EACH	£23.50
D042505	No.5 (E) Robur Die	EACH	£23.50
D042506	No.6 (F) Robur Die	EACH	£23.50
D042507	No.7 (G) Robur Die	EACH	£23.50
D042508	No.8 (H) Robur Die	EACH	£23.50
D042509	No.9 Robur Die	EACH	£23.50
D042510	No.10 (K) Robur Die	EACH	£23.50
D042511	No.11 (L) Robur Die	EACH	£23.50
D042512	No.12 (M) Robur Die	EACH	£23.50
D042513	No.13 (N) Robur Die	EACH	£23.50
D042514	No.14 (O) Robur Die	EACH	£23.50
D042515	No.15 (P) Robur Die	EACH	£23.50
D042516	No.16 (R) Robur Die	EACH	£23.50
D042517	No.17 (S) Robur Die	EACH	£23.50
D042518	No.18 (U) Robur Die	EACH	£23.50
D042519	No.19 (V) Robur Die	EACH	£23.50
D042520	No.20 (X) Robur Die	EACH	£23.50
D042521	No.21 Robur Die	EACH	£23.50
D042522	No.22 Robur Die	EACH	£23.50
D042523	No.23 Robur Die	EACH	£23.50



**PRESS & DIES,
STERNKREUZ**

Dies Individual, Sternkreuz



Specifically for Sternkreuz glass fitting tools

- Acrylic dies
- Base fitting Ø10mm

Code	Description	UOM	Price
D7198	No.OA (Ø6mm) Die	EACH	£6.25
D7199	No.14 (Ø14mm) Die	EACH	£2.15
D22965	No.18 (Ø18mm) Die	EACH	£2.15
D22966	No.19 (Ø19mm) Die	EACH	£2.15
D22967	No.20 (Ø20mm) Die	EACH	£2.15
D22287	No.22 (Ø22mm) Die	EACH	£2.15
D22288	No.25 (Ø25mm) Die	EACH	£2.15
D40219	No.26 (Ø26mm) Die	EACH	£2.15
D22302	No.33 (Ø33mm) Die	EACH	£2.15
D26022	No.38 (Ø38mm) Die	EACH	£2.15
D49311	No.42 (Ø42mm) Die	EACH	£2.15

**WATCH CASE
CUSHIONS**

Help stabilise your watch case while you work:

- Casing and uncasing of movements, making adjustments etc.
- For non scratching the crystal
- Snapping on case backs
- Tightening or loosening movement screws
- Standard, gel, synthetic or non slip
- With or without dust cover
- Bergeon Swiss, Horotec Swiss or unbranded

Gel Cushions, Bergeon

- Gel case cushions
- Soft, malleable material, leaving no marks
- Will not scratch parts
- Matches the shape of watch case of all shapes
- For casing and decasing of movements, making adjustments etc.
- Non slip base
- Black, neutral or white
- Bergeon 5395

For full specification see additional information

www. Online Discounts

Black, Ø55mm Gel Case Cushion



- Ø55mm
- Height 20mm
- Soft, malleable material, leaving no marks
- Will not scratch parts
- Matches the shape of watch case of all shapes
- For casing and uncasing of movements, making adjustments etc.
- Non slip base
- Black colour
- Bergeon 5395-55.N

Code	Description	UOM	Price
C51734	Black, Ø55mm Gel Case Cushion	EACH	£22.50

Black, Ø75mm Gel Case Cushion



- Ø75mm
- Height 20mm
- Soft, malleable material, leaving no marks
- Will not scratch parts
- Matches the shape of watch case of all shapes
- For casing and uncasing of movements, making adjustments etc.
- Non slip base
- Black colour
- Bergeon 5395-75.N

Code	Description	UOM	Price
C51735	Black, Ø75mm Gel Case Cushion	EACH	£24.50

Neutral, Ø55mm Gel Case Cushion



- Ø55mm
- Height 20mm
- Soft, malleable material, leaving no marks
- Will not scratch parts
- Matches the shape of watch case of all shapes
- For casing and uncasing of movements, making adjustments etc.
- Non slip base
- Neutral colour
- Bergeon 5395-55

Code	Description	UOM	Price
C40488	Neutral, Ø55mm Gel Case Cushion	EACH	£22.50

Neutral, Ø75mm Gel Case Cushion



- Ø75mm
- Height 20mm
- Soft, malleable material, leaving no marks
- Will not scratch parts
- Matches the shape of watch case of all shapes
- For casing and uncasing of movements, making adjustments etc.
- Non slip base
- Neutral colour
- Bergeon 5395-75

Code	Description	UOM	Price
C40489	Neutral, Ø75mm Gel Case Cushion	EACH	£24.50

**Watch Case
Back Gasket
Grease
Applicator**



See Page 1264

White, Ø55mm Gel Case Cushion

- Ø55mm
- Height 20mm
- Soft, malleable material, leaving no marks
- Will not scratch parts
- Matches the shape of watch case of all shapes
- For casing and uncasing of movements, making adjustments etc.
- Non slip base
- White colour
- Bergeon 5395-55.B

Code	Description	UOM	Price
C51736	White, Ø55mm Gel Case Cushion	EACH	£22.95

White, Ø75mm Gel Case Cushion

- Ø75mm
- Height 20mm
- Soft, malleable material, leaving no marks
- Will not scratch parts
- Matches the shape of watch case of all shapes
- For casing and uncasing of movements, making adjustments etc.
- Non slip base
- White colour
- Bergeon 5395-75.B

Code	Description	UOM	Price
C51737	White, Ø75mm Gel Case Cushion	EACH	£24.95

Gel Cushions, Cousins

- Gel case cushions

- Soft, malleable material, leaving no marks
- Will not scratch parts
- Matches the shape of watch case of all shapes
- For casing and decasing of movements, making adjustments etc.
- Non slip base
- Cousins high quality range

For full specification see additional information

Code	Description	UOM	Price
C49425	Ø55mm Gel Cushion	EACH	£11.95
C49424	Ø75mm Gel Cushion	EACH	£13.50

Padded Cushions, Bergeon

- Felt hollow centre covered with synthetic non-scratching material
- For casing and decasing of movements, making adjustments etc.
- Non slip base
- Ø50mm overall diameter
- 13mm High
- Weight 35g
- Bergeon 5394

Code	Description	UOM	Price
C0347	Padded (Ø50mm) Cushion, Bergeon	EACH	£24.95

Padded Cushions, Value

- Padded
- Synthetic non-scratching material cover
- Non slip base
- Ø50 or Ø75mm overall diameter
- Great value

For full specification see additional information

Padded (Ø50mm) Cushion

- Ø50mm
- Sunken central zone, padded top, felt base

Code	Description	UOM	Price
C7984	Padded (Ø50mm) Cushion	EACH	£3.75

Padded (Ø75mm) Cushion

- Ø75mm
- 35g

Code	Description	UOM	Price
C31271	Padded (Ø75mm) Cushion	EACH	£4.75

Rubber Cushions

- Ø90mm
- Height 16mm
- Anti scratch synthetic rubber polymer material
- Reversible
- One flat side with compartment for small parts
- One side with concave recess for cases with domed watch glasses
- Delivered with anti-dust lid
- Horotec 09,305
- Swiss made

Code	Description	UOM	Price
C44318	Ø90mm Cushion with Dust Cover	EACH	£27.50



Silicone Cushions

- Silicone, non slip cushions
- Soft, non slip material, leaving no marks
- Wipe washable with soapy water
- Includes extra non slip silicon base
- Includes additional silicon cushion protector (C39291)
- Bergeon Swiss

For full specification see additional information

Silicone (Ø55mm) Cushion, Bergeon

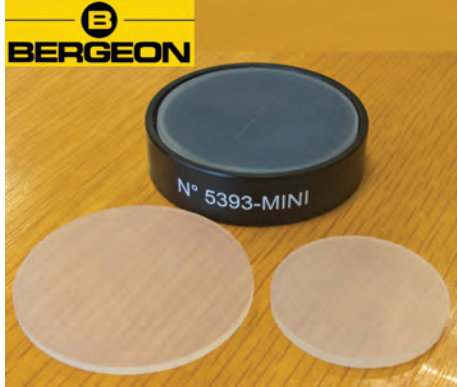

- Ø55mm
- Height 16mm
- Soft, non slip material, leaving no marks
- Wipe washable with soapy water
- Includes extra non slip silicon base
- Includes additional silicon cushion protector (C39291)
- Weight 50g
- Bergeon 5393-55

Code	Description	UOM	Price
C40487	Silicone (Ø55mm) Cushion, Bergeon	EACH	£41.95

Silicone (Ø75mm) Cushion, Bergeon

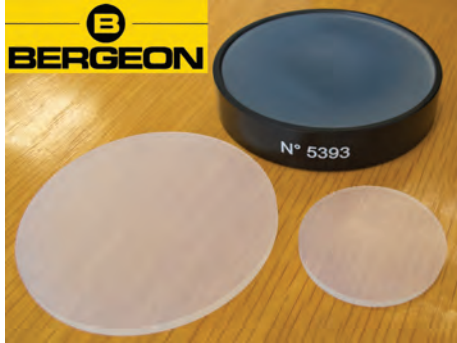

- Ø75mm
- Height 16mm
- Soft, non slip material, leaving no marks
- Wipe washable with soapy water
- Includes extra non slip silicon base
- Includes additional silicon cushion protector (C39291)
- Weight 50g
- Bergeon 5393-75

Code	Description	UOM	Price
C39008	Silicone (Ø75mm) Cushion, Bergeon	EACH	£42.75

Silicone Cushion Protector (Ø40mm), Bergeon



- Ø40mm diameter
- Use to protect casing cushion surface against indentation marks
- Extra protection for bezel claws, horns, bezels etc
- Bergeon 5393-P40

Code	Description	UOM	Price
C39291	Silicone Cushion Protector (Ø40mm), Bergeon	EACH	£3.45

WATCH CASE HOLDING



Watchmakers and repairers use watch case holding tools to hold watches securely while opening them up for a variety of reasons, from battery changes and glass replacement to full on repairs or servicing.

- CousinsUK brings you a large variety of watch case holders, including watch holding vices with plastic posts which prevent marring
- Posts are removable and can be set into different positions for various size and shape cases
- Most open and close with large knurled knob
- Many of our holders have frames that can fit into bench vices, for extra immovability
- Also available are our case holders with watch strap post aids, holding in place a watch strap or bracelet keeping your view free and unobstructed as well as leaving both hands free for your work
- For something different why not try our wooden case holder, this has the added benefit that it can be used for extra delicate work, as softer wood will not mark or scratch a case
- Pocket watch display holders are also available, an elegant solution to display your own or indeed your customers' pocket watches



Bench Top, A*F Swiss



Case Holding Stands - A*F Swiss

- Supports the watch while working on the case, movement or bracelet
- Sits on your work bench
- Soft, rubber inserts protects even the most delicate of items
- Easily work on all shaped cases
- Brilliant for watches with domed glasses
- Set of 3: Ø24, 30 & 40mm
- Base diameter Ø50mm
- Height 25mm
- Supplied in plastic storage and transport case
- Replacements available

Code	Description	UOM	Price
C40279	Watch Case Holder Set	PACK*3	£59.95
C40280	Ø24mm Case Holder	EACH	£18.95
C40281	Ø24mm Case Holder Insert	EACH	£3.95
C40282	Ø30mm Case Holder	EACH	£18.95
C40283	Ø30mm Case Holder Insert	EACH	£3.95
C40284	Ø40mm Case Holder	EACH	£18.95
C40285	Ø40mm Case Holder Insert	EACH	£3.95

Bench Top, Swiss Made - King Size



Swiss Made - Case Holding Stand

- Solid case holder designed for holding today's modern large size watches
- Can hold cases of many shapes and sizes
- Can hold case from Ø20 to Ø60mm
- Two directional adjusting screws
- Interchangeable holding pins
- Rubber feet for maximum stability
- Rubber ring cushion to protect the watch glass and bezel
- Supplied with 4 white nylon jaws
- Black plastic jaws available for special shaped cases or cases with pushers

Code	Description	UOM	Price
C40286	Bench Top Case Holder, King size	EACH	£114.95
C40288	Black Plastic Jaws for Case Holder	PACK*4	£34.95
C40287	White Nylon Jaws for Case Holder	PACK*4	£34.95



Bracelet & Case (Integrated)

VALUE



Case Holding - Watches with Integrated Bracelets

Tool to handle watches with integrated bracelets allowing user to keep the bracelet open while working inside the case.

- Comes with reversible case holding die, Ø30mm or Ø35mm (Universal case dies code C20829)
- 125 x 60mm
- Weight: 260g
- Made in India

Code	Description	UOM	Price
C37140	Watch Case Holder, Indian	EACH	£7.95

Bracelet & Case (Integrated), Horotec



Case Holding - Watches with Integrated Bracelets - Horotec Swiss

Tool to handle watches with integrated bracelets allowing user to keep the bracelet open while working inside the case.

- Dimensions: 60 x 105 mm
- Weight: 260g

Code	Description	UOM	Price
C30554	Horotec MSA 10.007 Watch Case Holder	EACH	£33.95

Clamp On, Indian

Case Holding - Watch - With Table Clamp

- Ø50mm capacity
- Ideal to fix to work bench
- Portable, easy to move
- No need for a bench vice
- Provides extra stability
- Metal body
- Made in India

Dimensions:
 • 115 x 80mm
 • Weight: 250g

Code	Description	UOM	Price
M39632	Clamp On, Ø50mm Capacity Case Holder	EACH	£5.95



Hand or Vice Held

Ø33mm Capacity, Metal Body

- Up to Ø33mm
- 4 red plastic multi position pegs
- Metal body
- Size 45 x 35 x 20mm



Code	Description	UOM	Price
C35087	Ø33mm Capacity, Metal Body	EACH	£3.95

Ø35mm Capacity, Metal Body

- Held in bench vice
- Up to Ø35mm
- 4 white plastic multi position pegs
- Metal body
- For replacement pegs see P36116
- Size 55 x 45 x 25mm



Code	Description	UOM	Price
C5326	Ø35mm Capacity, Metal Body	EACH	£4.95

Ø35mm Capacity, Metal Body - Crab

- Hand held
- Up to Ø35mm
- 4 red plastic multi position pegs
- Metal body
- Size 80 x 70 x 30mm
- Crab Style



Code	Description	UOM	Price
C39414	Ø35mm Capacity, Metal Body - Crab	EACH	£8.95

Ø45mm Capacity, Wooden Body

VALUE



- Ø45mm capacity
- Lightweight, non marking movement case holder
- Twin sided, precise machined holding compartments
- Easy action wing nut opening and closing method
- Carve or mill your own shape & design

Code	Description	UOM	Price
C36092	Ø45mm Capacity, Wooden Body	EACH	£3.95

Ø55mm Capacity, Metal Body

VALUE



- Up to Ø55mm
- 4 red plastic multi-position pegs
- Metal body
- For positioning pegs see C36094
- Size 70 x 65 x 25mm

Code	Description	UOM	Price
C31293	Ø55mm Capacity, Metal Body	EACH	£7.50

Jaw for C5326

VALUE



- Spare positioning pegs for C5326

Code	Description	UOM	Price
P36116	Jaw for C5326	PACK*4	£1.95

Jaw for C31293

VALUE



- Spare positioning pegs for C31293

Code	Description	UOM	Price
C36094	Jaw for C31293	PACK*4	£2.25

Hand or Vice Held, Bergeon

Ø35mm Capacity, Bergeon 5090



- Small Model
- Held in bench vice
- Body of nylon
- Red plastic chucks
- Capacity max Ø35mm
- Size 45 x 35 x 65mm

Code	Description	UOM	Price
C0303	Ø35mm Capacity, Bergeon 5090	EACH	£39.95

Watch Dial Protection Sheets

See Page 1282



SAME DAY DISPATCH

Ø44mm Capacity, Bergeon 2820

- Held in bench vice
- Body of steel
- Chucks in red plastic
- Capacity max Ø44mm



Code	Description	UOM	Price
C0306	Ø44mm Capacity, Bergeon 2820	EACH	£84.95

Ø65mm Capacity, Bergeon 5685

- Large model
- Can be fitted to bench vice
- Body of polyamide
- Red plastic jaws
- Capacity max Ø65mm
- Size 70 x 40 x 100mm



Code	Description	UOM	Price
C0304	Ø65mm Capacity, Bergeon 5685	EACH	£89.50

Jaw for Bergeon 2820

Replacement / Spare Jaw for Case Holding Tool
• Bergeon 2820 (C0306)



Code	Description	UOM	Price
C21205	Jaw for Bergeon 2820	EACH	£2.45

Jaw for Bergeon 5090A

Replacement / Spare Jaw for Case Holding Tool
• Bergeon 5090 (C0303)



Code	Description	UOM	Price
C22278	Jaw for Bergeon 5090A	EACH	£3.15

Jaw for Bergeon 5685

• Replacement Jaw for Case Holder 5685 (C0304)
• Bergeon 5685A



Code	Description	UOM	Price
C0305	Jaw for Bergeon 5685	EACH	£4.50

Screw Down with Base

VALUE



Case Holding - Watch - With Base

- Ø60mm capacity
- Ideal to fix to work bench
- No need for a bench vice
- Provides extra stability
- Supplied with fixing screws
- Made in India

Dimensions:
• 110 x 65mm
• Weight: 750g

Code	Description	UOM	Price
C37837	Ø60mm Capacity Case Holder with Base	EACH	£11.50

Unifix Case Holder for Vices

COUSINSUK



Unifix Case Holder

- High quality, traditional case holder
- Sits in a bench vice
- Simply rotate platform to move case holding pins. It's knurled round the edge for extra grip
- Platform rotates left and right for extra quick case holding or release
- Height adjusting case platform, gives ease of access and preference of working height
- Case platform with rubber coating to protect the watch glass
- Plastic coated jaw holders, prevents damage to the watch case
- Sturdy stainless steel
- Made in Germany

C44196 Specifications:
• Holds cases from Ø28 to Ø45mm
• Ø20mm case platform width
• 4 x 15mm tall screw in jaws
• Ø80mm x 50mm (width x height)
• 650g

C44197 Specifications:
• Holds cases from Ø28 to Ø68mm (by changing the position of the jaws)
• Ø25mm case platform width
• 4 x 15mm tall screw in jaws
• 4 x 22mm tall screw in jaws

- Ø110mm x 70mm (width x height)
- 950g

Code	Description	UOM	Price
C44196	Ø22mm to Ø45mm Unifix Case Vice	EACH	£64.95
C44197	Ø28mm to Ø68mm Unifix Case Vice	EACH	£138.95

WATCH CLEANING

ELMA WATCH CLEANING - ELMA SOLVEX

Elma Solvex VA

Elma Solvex VA



Elma Solvex VA - The new standard for the use of flammable solvents in watch movement cleaning.

- Multi frequency Ultrasonic & Vacuum Technology Cleaning
- Self Contained Discharge of Toxic Solvent Vapours
- Explosion Proof, TUV Rheinland Safety Approved & CE Certified
- The only watch cleaning machine with ATEX certification

Elmasolvex VA uses the best ultrasonic cleaning technology combined with vacuum inducing technology, whilst eliminating the grave threat of fire or explosion with its self-contained vapour filtration system.

A CE certified and TUV certificated safety requirement, this in house vacuum pump removes any risk of fire or explosion, by controlled discharge of solvent vapours. The use of ultrasound cleaning technology is thus legally possible and permitted.

- Pre-set or individually programmable cleaning cycles
- Cleaning and rinsing using multi-frequency ultrasound in rotation or oscillation process
- Parts are cleaned in a chamber in which cleaning and rinsing solutions are changed automatically
- Vacuum technology in this chamber also reaches difficult-to-access places and removes all gas bubbles from the movements and parts
- Ex-certified solvent-based cleaning of watch movements (TAceV Rheinland)
- Protection against solvent vapours and odours using extraction or self-contained filter system
- Machine can be completely rotated, media containers and connections are very easily accessible
- Media containers are easy to replace and rinse out.

Integrated particle filter for increasing the service life of the cleaning and rinsing solutions

- Closed system ensures minimal evaporation of cleaning fluid
- Filters through the fluid containers and cleaning chamber ensure no lost parts
- Quiet operation and containment of fumes and smells make for a better, safer working environment (workshop or retail)
- Wide range of practical accessories; see accessories catalogue
- 220 to 240 Volt (230 to 110 volt converter please see our code A52044)
- CE marked
- Made in Germany

Ultrasonic and vacuum technology guarantees

- Maximum cleanliness due to removal of interfering gas bubbles
- Explosion safety due to the Ex-protection measures integrated in the machine
- Ex-certified for flammable solvents with flashpoint ~ = 12 °C

Machine Includes:

- Ø80mm Basket frame, anti-static, Elma 105 3905 (R37650)
- Liquid container x4, Elma 103 8653 (R37673)
- Exhaust outlet tubes

Optional Extras:

- Ø80mm Basket set complete (R37640)
- Ø80mm Basket set complete, rilsan coated (R37641)
- Ø80mm Basket frame (R37649)
- Ø80mm Basket frame, anti-static (R37650) (one already included with machine)
- Ø64mm Basket set complete, including frame, lid & adapter (R37642)
- Ø64mm Basket frame (R37667)
- Ø64mm Basket adapter (R37668)
- Ø64mm Basket frame lid (R37669)
- Activated carbon unit (R37643)

Dimensions:

- Ø600mm x 606mm (Height), 50Kg

Code	Description	UOM	Price
R37628	Elmasolvex VA, 240 Volt	EACH	£10,995.00
R37682	Elma Solvex VA, 110 Volt (Japan)	EACH	£10,995.00
R37681	Elma Solvex VA, 115 Volt	EACH	£10,995.00

Ø64mm Basket & Fittings



Elma Solvex VA - Ø64mm Baskets & Fittings

If you already have (or even prefer) Ø64mm baskets, here are the fittings needed to adapt the Elma solvex VA for use with Ø64mm baskets.

- To use Ø64mm baskets with the VA, the basket frame, basket frame lid & adapter are used (all listed below)
- These items are all included, along with 4 baskets and a basket lid, in the basket set complete (R37642)
- For a full range of Ø64mm Baskets/Trays see Elma Solvex RM/SE (See link below)
- For mini watch cleaning baskets/parts capsules see code R37658

Code	Description	UOM	Price
R37668	Basket Adapter	EACH	£83.95
R37642	Basket Set Complete	EACH	£215.00
R37667	Basket Frame	EACH	£21.50
R37669	Basket Frame Lid	EACH	£34.50

Ø80mm Basket & Fittings



Elma Solvex VA - Ø80mm Baskets & Fittings

The range of accessories, replacements and fittings for the Ø80mm basket. Many different styles of tray available ensures you can have the right one for your job.

Trays available in:

Stainless Steel:

- Long lasting standard trays
- Electro polished

Rilsan Coated (RC):

- Stainless Steel covered in Rilsan
- A soft plastic coating that protects delicate parts
- Better drying properties than completely plastic trays

For mini watch cleaning baskets/parts capsules see code R37658

Code	Description	UOM	Price
R37640	Basket Set Complete	EACH	£695.00
R37641	Basket Set Complete (RC)	EACH	£795.00
R37649	Basket Frame	EACH	£93.50
R37650	Basket Frame, Anti Static	EACH	£93.95
R37651	Basket Lid	EACH	£44.95
R37660	Basket Lid (RC)	EACH	£54.95
R37652	Tray, 1 Section	EACH	£99.95
R37661	Tray, 1 Section (RC)	EACH	£109.05
R37657	Tray, 1 Section Double Height	EACH	£115.00
R37666	Tray, 1 Section Double Height (RC)	EACH	£136.95
R37653	Tray, 4 Section	EACH	£115.00
R37662	Tray, 4 Section (RC)	EACH	£149.95
R37654	Tray, 8 Section	EACH	£159.95
R37663	Tray, 8 Section (RC)	EACH	£165.00
R37655	Tray, 11 + Ø25mm Centre Section	EACH	£165.00
R37664	Tray, 11 + Ø25mm Centre Section (RC)	EACH	£189.95
R37656	Tray, 11 + Ø40mm Centre Section	EACH	£165.00
R37665	Tray, 11 + Ø40mm Centre Section (RC)	EACH	£196.95

Ø80mm Movement Holders

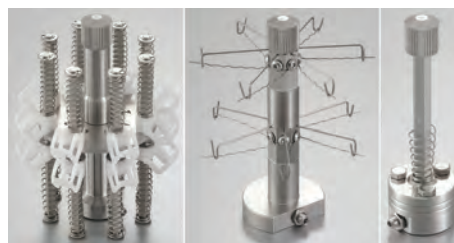

Elma Solvex VA - Ø80mm Movement Holders

Designed specifically for cleaning whole movements in the Elma Solvex VA.

- Type 1 - Spring loaded holder that gives the best support for cleaning watch movements
- Type 2 - Mainly designed for manufacturers, where cleaning does not require excessive movement
- Adapter - Designed so that other other Swiss made cleaning machine movement holders will work with The Solvex VA

Code	Description	UOM	Price
R37646	Movement Holder Type 1	EACH	£188.95

R37647	Movement Holder Type 2	EACH	£199.95
R37648	Movement Holder Adapter	EACH	£99.95

Activated Carbon Unit



Elma Solvex VA - Activated Carbon Unit

When there is no outdoor vent, fully self contained (great for showrooms/boutiques). Breaks down harmful and combustible fluid vapour. Prevents potentially harmful fumes from escaping into your working environment as well as preventing any possible combustion of flammable cleaning fluid vapour.

- Used with the Elma Solvex VA
- Carbon activated filter
- Needs no outdoor vent
- Fully self contained
- Lasts for up to 500 cycles*
- Replacements available

* Dependent on type of cleaning (ultrasonic/vibrosonic), heating and solvents used. As a minimum you can expect 150 to 200 cycles.

Code	Description	UOM	Price
R37643	Activated Carbon Filtration Unit	EACH	£850.00
R37644	Refill Set	PACK*3	£54.95
R37645	Replacement Filter	EACH	£30.95

Elma Solvex RM & SE

Elma Solvex RM



Elma Solvex RM - Can proven technology be improved?

For watchmakers and service centres who prefer to clean without ultrasound

- TUV and CE certified explosion-protection
- Maximum personnel and workshop safety due to connection of the machine to controlled exhaust air routing
- Now with 4 cleaning chambers and one drying chamber (fine filter, warm air technology)

- Solvent based or semi aqueous cleaning
- Completely automatic or with individually configurable parameters
- Service-friendly and easy-to-care for design
- Basket frame for five baskets, optional holder for circuit boards
- Wide range of practical accessories
- Rotation counter current principle combined with oscillation cleaning
- 240 (UK) or 115 volt versions available
- 220 to 240 Volt (230 to 110 volt converter please see our code A52044)
- Made in Germany

Machine Includes:

- Basket Lid, Ø64mm, Elma 1053496
- Jar x4, Elma 1049708
- Jar Lid x 4, Elma 1053139
- Wave Breaker x 4, Elma 1048417

Optional extras:

- Ø64mm Basket complete (C0386)
- Ø64mm Basket frame (R37674)
- Ø64mm Basket lid (C0386F)
- Ø64mm Tray (C0386E)
- Ø64mm Tray, Full Height (C0386E)
- Ø64mm 4 section tray (C0386C)
- Ø64mm 5 section tray (C0386D)
- Ø64mm 9 section tray (R37670)

Dimensions:

- Ø525mm x 650mm (Height)
- 28.5Kg

Code	Description	UOM	Price
R37629	Elmasolvex RM, 230 Volt	EACH	£3,495.00
R48551	Elmasolvex RM, 115 Volt	EACH	£3,495.00

Elma Solvex SE



Elma Solvex SE - Can a classic be invented again?

- TÄceV-certified explosion safety
- Maximum personnel and workshop safety due to connection of the machine to controlled exhaust air routing
- Now with 4 cleaning chambers and one heating chamber (fine filter, warm air technology)
- Manual operation with latching in the working heights and above the media container positions
- Service-friendly and easy-to-care for design
- Basket frame for five baskets, optional holder for circuit boards
- Wide range of practical accessories; see accessories catalogue
- Rotation counter current principle
- 220 to 240 Volt (230 to 110 volt converter please see our code A52044)
- CE marked
- Made in Germany

Machine Includes:

- Basket Lid, Ø64mm, Elma 1053496
- Jar x4, Elma 1049708
- Jar Lid x 4, Elma 1053139
- Wave Breaker x 4, Elma 1048417

Optional extras:

- Ø64mm Basket complete (C0386)
- Ø64mm Basket frame (R37674)
- Ø64mm Basket lid (C0386F)
- Ø64mm Tray (C0386E)
- Ø64mm Tray, Full Height (C0386E)
- Ø64mm 4 section tray (C0386C)
- Ø64mm 5 section tray (C0386D)
- Ø64mm 9 section tray (R37670)

Dimensions:

- Ø500mm x 703mm (Height)
- 24Kg

Code	Description	UOM	Price
R37630	Elmasolvex SE	EACH	£1,695.00

Ø64mm Baskets & Fittings



Elma Solvex - RM90 - Ø64mm Baskets & Fittings

This range of baskets and fittings can be used across Elma cleaning machine range.

- Used in Elma Solvex VA, RM & SE
- Used in Elma RM90
- Basket frame R37674 for RM & SE only
- For mini watch cleaning baskets/parts capsules see code R37658

Code	Description	UOM	Price
C0386	Basket Complete	EACH	£120.00
R37674	Basket Frame	EACH	£21.50
C0386F	Basket Lid	EACH	£11.95
C0386E	Tray (1 Section)	EACH	£18.75
C0386B	Tray (1 Section) Full Height	EACH	£34.95
C0386C	Tray (4 Section)	EACH	£26.95
C0386D	Tray (5 Section)	EACH	£34.95
R37670	Tray (9 Section)	EACH	£35.95

Ø64mm Movement Holder



Elma Solvex - Ø64mm Movement Holder

This range of baskets and fittings can be used across Elma cleaning machine range.

- Used in Elma Solvex RM & SE
- Used in Elma RM90

Code	Description	UOM	Price
C4811	Movement Holder	EACH	£89.95
C34695	Movement Holder Clip	EACH	£3.15

Jars, Lids & Wavebreakers



Elma Solvex - Jars, Lids & Wavebreakers

A complete replacement range for the Elma Solvex RM/SE. You won't find anyone with more accessories or spare parts.

Code	Description	UOM	Price
R37675	Jar Complete	EACH	£48.95
R37676	Jar with Wavebreaker	EACH	£40.95
R37677	Jar Lid	EACH	£3.50
R37678	Jar Seal	EACH	£7.95
R37679	Wavebreaker	EACH	£5.95

GREINER WATCH CLEANING

Greiner ACS900 Cleaning Machine

Greiner



An industry favourite and still a best seller - Fully automatic with Ultrasonic

Cousins incorporates a full set of Ø60mm baskets and accessories with multiple tray configurations, as well as movement holders and fittings, with this machine. A complete list is available below.

- Fully automatic operation, simple to set up and use
- Ultrasonic function
- Programmable cycle memories
- Totally independent controls & fully enclosed mechanism
- Quiet and smooth running
- All metal housing, uncompromised swiss build quality
- 20 piece basket/accessory kit
- 4 jar system & drying position
- Manufacturers one year guarantee
- 425 x 425 x 565mm (L x D x H), weight 31Kg
- 220 to 240 Volt (230 to 110 volt converter please see our code A52044)

The Greiner ACS900 has many practical features which includes a multi-memory function enabling the user to simply repeat a choice of personally programmed cycles according to regular work type and flow with

preferred or favourite settings. Conversely the operator has complete control if required to run a full or part cycle and action exactly as desired by simply entering independent settings at the beginning to bypass a memory function.

The Greiner will still automatically proceed through the programme you have chosen. The detailed instructions reveal the machines full potential, in particular the universal flexibility of the 4 jar system modified here so that you can organize the purpose of each jar and its running duration, this can be achieved via both a memory cycle you have already stored in the data bank, or by independent programme entry per jar at the start of the event.

Accessories Included:

- Ø64mm Basket complete including:
 - Basket holder, Greiner 17901 (C12182)
 - Basket frame, Greiner 17092 (C12183)
 - Basket lid, Greiner 17132 (C12184)
 - Tray, Open Ø64mm, Greiner 17129 (C12185)
 - Tray, 4 partitions Ø64mm, Greiner 17128 (C12186) x 2
 - Tray, 5 Partitions Ø64mm, Greiner 17127 (C12187)

- Ø64mm Movement holder complete including:
 - Movement holder support, Greiner 17122 (C12188)
 - Three movement holder (Horizontal), Greiner 17123 (C12189) x 5

- Other accessories included:
 - Coupling for basket holder (for Ø64 & Ø80mm basket holders), Greiner 17190 (C32097)
 - Ultrasonic tank, Greiner 17142
 - Glass jar, Greiner 17135 (C8860A) x 3
 - Glass jar lid, Greiner 17136 (C12170) x 4
 - Mini basket Ø20mm, Greiner 17131 (C12181)
 - Parts capsule, Greiner 17134 (C12180)
 - Wavebreaker, Greiner 17938 (C12171) x 3
 - Ultrasonic-Oscillator circuit 230V, Greiner 17102 (C47526)

Code	Description	UOM	Price
C8860	Greiner ACS900 Ultrasonic Cleaning Machine	EACH	£7,995.00

Basket Holder (Ø64mm & Ø80mm)

Universal holder coupling, will attached both Ø64mm & Ø80mm basket holders.



Allows your ACS900 to accept either diameter baskets without the need to physically change coupling.

- ACS900
- Aluminium
- For attachments 17091, 17098 & 17122

Code	Description	UOM	Price
C32097	Holder Coupling Ø64mm & Ø80mm, Greiner 17190	EACH	£129.95

Ø64mm Basket & Fittings



Ultrasonic Watch Cleaning Machine - Greiner ACS900

Code	Description	UOM	Price
C12182	Basket Holder, Greiner 17091	EACH	£46.95
C12183	Basket Frame, Greiner 17092	EACH	£46.95
C12184	Basket Lid (Mesh), Greiner 17132	EACH	£13.50
C12185	Tray (1 Section) Ø64mm, Greiner 17129	EACH	£20.95

C12186	Tray (4 section) Ø64mm, Greiner 17128	EACH	£25.50
C12187	Tray (5 Section) Ø64mm, Greiner 17127	EACH	£34.95

Ø64mm Movement Holder & Fittings



Ultrasonic Watch Cleaning Machine - Greiner ACS900

Code	Description	UOM	Price
C12188	Movement Holder Support, Greiner 17122	EACH	£45.95
C12189	Movement Holder (Horizontal) Ø64mm, Greiner 17123	EACH	£14.95
M35424	Movement Holder (Vertical) Ø64mm, Greiner 17137	EACH	£195.00

Ø80mm Basket & Fittings



Ultrasonic Watch Cleaning Machine - Greiner ACS900

Available in metal or plastic

Code	Description	UOM	Price
C32062	Ø80mm Holder Coupling, Greiner 17099	EACH	£159.95
C12174	Basket Holder, Greiner 17098	EACH	£134.95
C12179	Basket Frame, Greiner 15853	EACH	£174.95
C12175	Basket Lid (Mesh), Greiner 15852	EACH	£21.95
C55178	Basket Lid (Mesh), Greiner 15880, Plastic	EACH	£31.95
C12176	Tray (1 Section) Ø80mm, Greiner 15850	EACH	£46.95
C55179	Tray (1 Section) Ø80mm, Greiner 15881, Plastic	EACH	£55.95
C12177	Tray (4 Section) Ø80mm, Greiner 15851	EACH	£54.95
C55180	Tray (4 Section) Ø80mm, Greiner 15882, Plastic	EACH	£69.95
C12178	Tray (8 Section) Ø80mm, Greiner 15849	EACH	£79.95
C55181	Tray (8 Section) Ø80mm, Greiner 15883, Plastic	EACH	£89.95
C8860B	Tray (12 Section) Ø80mm, Greiner 15848	EACH	£94.95
C55182	Tray (12 Section) Ø80mm, Greiner 15884, Plastic	EACH	£117.95

Watch Cleaning & Rinsing Fluids

See Page 1251



Circuit Board

Greiner 17102

- Circuit board for Greiner ACS900
- Ultrasonic-Oscillator circuit
- 230 Volt



Code	Description	UOM	Price
C47526	ACS900 Circuit	EACH	£795.00

Exhaust System (for ACS900)



Exhaust tubing system for the Greiner ACS900 machine.

Simply attach either size flexible tube to the vent on the top of the machine using the tube clamp, and the fumes will evaporate along the tube, out of your workshop.

- 2 sizes of expandable, flexible tubing available
- 20cm extends to 100cm
- 50cm extends to 250cm
- Internal diameter both Ø100mm
- External diameter both Ø108mm
- Clamp available separately (see code C37192)

Code	Description	UOM	Price
C37190	Exhaust Tube 20 - 100cm, Greiner 17106	EACH	£37.95
C37191	Exhaust Tube 50-250cm, Greiner 17107	EACH	£59.95
C37192	Exhaust Tube Clamp, Greiner 17108	EACH	£7.60
C37193	Exhaust Tube Connection Piece & Screws, Greiner 17105	EACH	£31.95

Jars, Lids & Wavebreakers (ACS900)



Ultrasonic Watch Cleaning Machine - Greiner ACS900

Code	Description	UOM	Price
C8860A	Glass Jar	EACH	£37.95
C12170	Glass Jar Lid	EACH	£14.95

C12171	Glass Jar Wavebreaker, Greiner 17938	EACH	£39.95
W7726	Vibrograph Fuses, 9561.630A001-900000	EACH	£4.95

WATCH CLEANING MINI BASKETS



Watch cleaning baskets are perfect for holding small watch parts in ultrasonic and steam cleaning machines.

- These two piece stainless steel baskets either screw tightly together or have a lid that sits on top to avoid the loss of small parts, while the mesh screens allow the cleaning solution to filter through the container cleaning the parts
- These small parts basket will hold screws, gemstones, watch parts, and other small items allowing you to immerse and clean them thoroughly without fear of losing them

Bergeon Mini Baskets



- Bergeon Swiss miniature baskets for holding small components
- Will fit into most cleaning machines or ultrasonic tanks
- Screw together top and bottom
- Stainless steel
- Available in 2 sizes

Code	Description	UOM	Price
C0388	Ø16 x 12mm Mini Baskets, Bergeon	EACH	£21.75
C0389	Ø23 x 13.5mm Mini Baskets, Bergeon	EACH	£21.75

Elma Mini Baskets



- Elma Baskets
- Non-screw lid
- Will fit into most cleaning machines or ultrasonic tanks

- Stainless steel

Code	Description	UOM	Price
R37658	Ø20 x 11.5mm Mini Basket & Lid	EACH	£19.95
C0387	Ø20 x 13mm Mini Basket & Lid, Elma	EACH	£19.95

Greiner Mini Baskets



- Will fit into most cleaning machines or ultrasonic tanks

Code	Description	UOM	Price
C12181	Ø20 x 13mm Mini Basket, Greiner 17131	EACH	£24.75
C12180	Ø22 x 6mm Parts Capsule, Greiner 17134	EACH	£11.95

Indian Mini Baskets



- Will fit into most cleaning machines or ultrasonic tanks

Code	Description	UOM	Price
B36258	Ø16 x 16mm Mini Basket	EACH	£1.70
B36259	Ø21 x 11mm Mini Basket, Stainless Steel	EACH	£1.70
B36464	Ø24 x 24mm Mini Sphere	EACH	£1.70

Price breaks available, see website

WATCH GAUGES

Crown Gauge

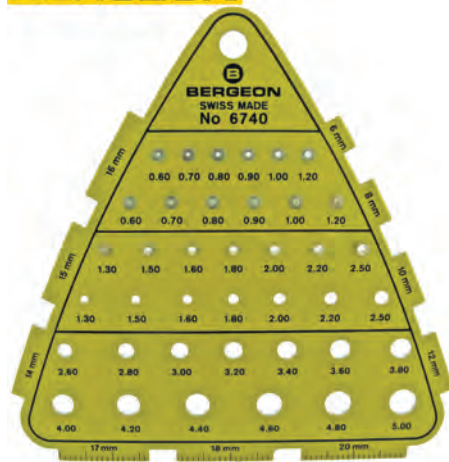

Bergeon 6740

- For measuring:
- Thread of Stems
 - Threads of Crowns
 - Diameters of Crowns

- Diameters of Pendant tubes
- Dimensions: 85 x 85 x 85 x 1 mm

Also suitable for measuring the distance between the lugs of watch cases.

Code	Description	UOM	Price
G0693	Watch Crown Gauge, Bergeon 6740	EACH	£37.50

Glass Gauge



Gauge for watch glasses

- Up to 70mm
- Aluminium
- Easy to store and transport
- Great value

Code	Description	UOM	Price
G39462	Watch Glass Gauge, Aluminium	EACH	£0.95

Hand Gauge



Bergeon 30464

- Accurately measures watch hand holes
- Can also be used for bushes and jewel holes

Code	Description	UOM	Price
G0698	Watch Hand Gauge, Bergeon 30464	EACH	£31.95

Ligne Gauge (for Watch Movements)

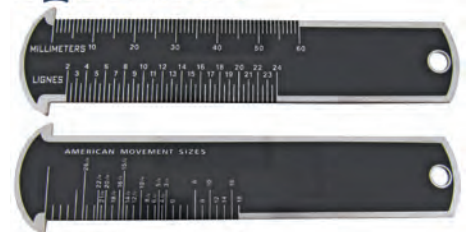

- Black
- Steel
- Between 2 to 24 ligne
- Millimeters 0 to 60mm
- For measuring the size of the watch movements

Code	Description	UOM	Price
G19002	Ligne Gauge	EACH	£2.45

Spring Bar Gauges

Callipers for measuring the distance between the lugs of a watch case.

- Both millimetre and inch display
- Millimetres: 8 to 22mm
- Inches: 5/16" to 7/8"
- Bergeon Swiss or Indian



Code	Description	UOM	Price
S39649	Spring Bar Gauge	EACH	£2.95
L0934	Spring Bar Gauge, Bergeon Swiss	EACH	£22.75

WATCH GLASS, DIAL & HAND CLEANING TOOLS

Glass, Dial & Hand (Watch) Cleaning Pen, Bergeon Swiss



Watch Glass, Dial & Hand Cleaning Pen - Bergeon Swiss

- Ideal for cleaning watch glasses without touching or handling the case
- Great for cleaning watch dials without leaving any marks
- Can be used for watch hands
- Also brilliant for polishing precious stones
- Better than any polishing cloth or swab
- Light & easy to handle
- Also fitted with a dust off brush
- Supplied with round and concave tip (Cousins Ref G39004)
- Triangular & round flat tips available
- Bergeon 7971

Code	Description	UOM	Price
G39003	Glass & Dial Cleaning Pen, Bergeon Swiss	EACH	£16.75
G39004	Ø12mm Round & Concave	EACH	£9.20
G39006	Ø12mm Round & Flat Tip	EACH	£9.20
G39005	10 x 10 x 10mm Triangular Tip	EACH	£9.20

Glass, Dial & Hand (Watch) Cleaning Pen, Cousins Swiss



Watch Glass, Dial & Hand Cleaning Pen - Cousins Swiss

- Made in Switzerland
- Ideal for cleaning watch glasses without touching or handling the case
- Great for cleaning watch dials without leaving any marks
- Can be used for watch hands
- Also brilliant for polishing precious stones
- Better than any polishing cloth or swab
- Light & easy to handle
- Also fitted with a dust off brush
- Supplied with round and concave tip (Cousins Ref G42449)
- Triangular & round flat tips available

Code	Description	UOM	Price
G42448	Glass & Dial Cleaning Pen, Cousins	EACH	£9.50
G42449	Ø12mm Round & Concave Tip	EACH	£4.75
G42450	Ø12mm Round & Flat Tip	EACH	£4.75
G42451	10x 10 x 10mm Triangular Tip	EACH	£4.75

Price breaks available, see website

Glass, Dial & Hand (Watch) Cleaning Pen - Mini, Bergeon Swiss



Watch Glass, Dial & Hand Cleaning Pen - Bergeon Swiss - Mini

- Designed specifically for watch hand cleaning
- Great for smaller more intricate glasses & dials
- Also brilliant for polishing precious stones
- Better than any polishing cloth or swab
- Light & easy to handle
- Also fitted with a dust off brush
- Supplied with round & flat tip (Cousins Ref G39671)
- Bergeon 7971- Mini

Dimensions:
 • Overall length: 90mm
 • Tip diameter: Ø5.5mm (approx)

Code	Description	UOM	Price
G39561	Glass, Dial & Hand Cleaning Pen	EACH	£16.85
G39671	Ø5mm Round & Flat Tip	EACH	£9.15

Glass, Dial & Hand (Watch) Cleaning Pen - Mini, Cousins Swiss



Watch Glass, Dial & Hand Cleaning Pen - Cousins - Mini

- Made in Switzerland
- Designed specifically for watch hand cleaning
- Great for smaller more intricate glasses & dials
- Also brilliant for polishing precious stones
- Better than any polishing cloth or swab
- Light & easy to handle
- Also fitted with a dust off brush
- Supplied with round & flat tip (Cousins Ref G42453)

Dimensions:
 • Overall length: 90mm
 • Tip diameter: Ø5.5mm (approx)

Code	Description	UOM	Price
G42452	Glass, Dial & Hand Cleaning Pen	EACH	£8.95
G42453	Ø5mm Round & Flat Tip	EACH	£4.75

Price breaks available, see website

WATCH HAND REMOVING AND FITTING

HAND (WATCH) COLLET TIGHTENING TOOL

Hand Collet Tightening Tool



Bergeon 3010 - Swiss Made

- Ensures that the pipe/collet is tightened evenly across it's entire circumference, ensuring a firm and even fit
- For watch hands, crowns and case tubes
- 18 interchangeable collets
- Supplied in stylish black wooden box



Cleaning Swabs
"very useful"

See Page 1253

Collet sizes:

- Ø0.40, 0.45, 0.50, 0.55, 0.60, 0.70, 1.10, 1.20, 1.30, 1.40, 1.50, 1.60, 1.70, 1.80, 2.00, 2.20, 2.40 & 2.60mm

Code	Description	UOM	Price
C43689	Hand & Crown Pipe & Case Tube Tightening Tool	EACH	£435.00

HAND (WATCH) FITTING PRESSES

Hand Fitting Multi Press (Watch), Non Swiss



Watch Hand Fitting - Fitting Press

- High precision hand fitting tool
- 3 posts make for quick, easy and accurate hand fitting
- Post height is adjustable
- Spring loaded press action
- Rotating stand
- Supplied with 3 dies for movement support
- As a budget item the finish may not be perfect
- Overall height 175mm

Tips:

- Ø1.50mm
- Ø1.00mm
- Ø0.60mm

Code	Description	UOM	Price
H47057	Hand Fitting Press	EACH	£55.95

Hand Fitting Multi Press (Watch), Bergeon Swiss



- High precision hand setting tool

- Enhanced guidance of the hand presses
- Excellent for intricate & delicate work
- 4 different stakes
- Holding base of Ø31mm
- Overall height 180mm
- Synthetic press tips ensures no scratching or marking
- Bergeon 8935
- Spare press tips available
- Ø2.60mm tip also available separately, this tip can be adjusted/sculpted to suit your need
- Intermediate plates are to be used with movement holders with hand setting pivots
- Additional press H44214, limits the force that can be exerted on hands. Force limiter adjustable from 5 Newtons to 40 Newtons

Tip sizes (External x Internal):

- Ø2.60 x 1.60mm (Yellow)
- Ø2.10 x 1.20mm (Red)
- Ø1.70 x 0.60mm (Grey)
- Ø1.50mm (Blue)

Intermediate Plates:

- Ø3.25mm Pivot
- Ø5.00mm Pivot

Code	Description	UOM	Price
H40483	Hand Fitting Press, Bergeon Swiss	EACH	£748.95
H44214	Runner with Torque (Measured Force)	EACH	£295.00
H40526	Ø1.50mm (Blue) Press Tip	EACH	£14.50
H40524	Ø1.70 x 0.60mm (Grey) Press Tip	EACH	£14.50
H40523	Ø2.10 x 1.20mm (Red) Press Tip	EACH	£14.50
H40522	Ø2.60 x 1.60mm (Yellow) Press Tip	EACH	£14.50
H40525	Ø2.60mm Press Tip (for bespoke)	EACH	£14.50
H43060	Ø3.25mm Pivot Intermediate Plate	EACH	£59.95
H43061	Ø5.00mm Pivot Intermediate Plate	EACH	£64.95

Hand Fitting Press (Watch), Horotec Swiss



Watch Hand Fitting - Fitting Press - Horotec Swiss

Hand fitting press for wrist and pocket watches. Allows for a quick, efficient and exact job. This tool gives precise control by holding the die vertically while pressing and fitting the hand into position.

- Watch Hand Fitting Press
- 8 different delrin stakes included
- Spring loaded press action
- Precise action
- Horotec 05.021

Dimensions:

- 60 x 50 x 105mm
- 220g

Code	Description	UOM	Price
H41119	Hand Fitting Press, Horotec Swiss	EACH	£61.95

H41120	Ø0.50mm Stake	EACH	£6.15
H41121	Ø0.70mm Stake	EACH	£6.15
H41122	Ø0.90mm Stake	EACH	£6.15
H41123	Ø1.20mm Stake	EACH	£6.15
H41124	Ø1.50mm Stake	EACH	£6.15
H41125	Ø1.70mm Stake	EACH	£6.15
H41127	Conical Stake	EACH	£6.15
H41126	Flat Stake	EACH	£6.15
H55373	Broach, Horotec	EACH	£11.55
H55117	Broach Spring, Horotec Swiss	EACH	£5.95

Hand Fitting Press (Watch), Horotec Swiss 3 Press



Horotec 05.022 - Swiss Made

Hand fitting press for wrist and pocket watches. Allows for a quick, efficient and exact job. This tool gives precise control by holding the die vertically while pressing and fitting the hand into position.

- Watch Hand Fitting Press
- With 3 presses, no need for constant die changing
- 8 different delrin stakes included
- Spring loaded press action
- Precise action
- For replacement stakes see from code H41120

Dimensions:

- 94 x 50 x 115mm
- 315g

Code	Description	UOM	Price
H44238	Hand Fitting Press, Horotec Swiss	EACH	£92.95

Hand Fitting Press (Watch), Horotec Swiss - 4 Press



Horotec 05.050 - Swiss Made

Hand fitting press for wrist and pocket watches. Allows for a quick, efficient and exact job. This tool gives precise control by holding the die vertically while pressing and fitting the hand into position.

- Watch Hand Fitting Press
- With 4 presses, no need for constant die changing
- Hour hand stake Ø1.35mm
- Minute hand stake Ø0.95mm
- Seconds stake Ø0.60mm
- Decentred stake
- Spring loaded press action
- Precise action
- Removable bottom plate means watch movement holders can be secured easily for extra precision
- See video link above

Dimensions:
 • 160 x 100 x 130mm
 • 1.45Kg

Code	Description	UOM	Price
H50419	Hand Press, Horotec 05.050	EACH	£425.00

Hand Fitting Press (Watch)



Watch Hand Fitting - Fitting Press

- Watch Hand Fitting Press
- 7 different hole diameters included
- Spring loaded press action
- Stainless steel construction
- Much sturdier & easier to use than other versions on the market
- Value item
- Made in India

Dimensions:
 • 65 x 80 x 150mm
 • 365g

Code	Description	UOM	Price
H37126	Hand Fitting Press	EACH	£13.95
H37761	Hand Fitting Stakes	PACK*7	£4.95



HAND (WATCH) FITTING TOOLS

Hand Fitting (Watch)

Hand Fitting Tool Set VALUE



- Set of 3 tools
- 90mm overall length
- Tool (blue/gold): Flat/0.80mm
- Tool (black/white): 1.00/0.50mm
- Tool (grey/red): 1.50/1.80mm
- Value item
- Knurled handles
- Brass bodies

Code	Description	UOM	Price
H37241	Hand Fitting Tool Set	PACK*3	£5.95

Hand Fitting Tool Set, Extra Long VALUE



- Set of 3 tools
- 140mm overall length
- Grey tool: 0.50 /1.00mm
- Red tool: 0.80/Flat 3.50mm
- Blue tool: 1.50/2.00mm
- Value item
- Knurled handles
- Lightweight aluminium

Code	Description	UOM	Price
H41169	Hand Fitting Tool Set, Extra Long	PACK*3	£6.50

Hand Fitting Tool, with Fibreglass Tips VALUE



- Fibreglass tips
- Hole size Ø0.50 & 1.00mm
- 95mm long
- Brass body
- Knurled handle

Code	Description	UOM	Price
H47059	Hand Fitting Tool, with Fibreglass Tips	EACH	£1.95

Hand Fitting Pressers VALUE



- Set of 3 pressers
- Supplied in pouch

- For fitting hands without scratching the dial

Code	Description	UOM	Price
H47058	Hand Fitting Pressers	PACK*3	£3.95

Hand Fitting (Watch), A*F Swiss



A*F Swiss

In plated brass, length 105mm, body diameter 6mm with two replaceable tips in nylon. Hole diameters 0.50mm & 1.00mm.

- Plated brass
- Body Ø6mm
- Two pierced end pieces
- Tips: 0.50 & 1.00mm
- Length 105 mm

Code	Description	UOM	Price
H7350	Ø0.50 & Ø1.00mm Tool	EACH	£9.95
H48027	Ø0.50mm Tip	EACH	£2.25
H48028	Ø1.00mm Tip	EACH	£2.25

Hand Fitting (Watch), A*F Swiss, Elegance



A*F 174.316 Swiss Made

Make hand fitting easy, with maximum control and accuracy. Thanks to their plastic ends, these tools are ideal to insert watch hands without scratching the dial. Two different hole diameters per tool available to ensure a perfect fit..

Aluminium handles in attractive blue anodised finish. Spare tips available.

Individual or Set of 3 tools:

- Ø0.50 & Ø1.00mm (white & black)
- Ø0.80mm & Concave (red & blue)
- Ø1.50mm & Flat (grey & brass)
- Swiss made

Code	Description	UOM	Price
H31401	Set of 3, A*F Swiss, Elegance	PACK*3	£29.95
H48019	Single Ø0.50 & Ø1.00mm (white & black)	EACH	£9.95
H48018	Single Ø0.80mm & Concave (red & blue)	EACH	£9.95
H48020	Single Ø1.50mm & Flat (grey & brass)	EACH	£9.95
H48025	Tip Ø0.50mm (White)	EACH	£2.95
H48023	Tip Ø0.80mm (Red)	EACH	£2.95
H48024	Tip Ø1.00mm (Black)	EACH	£2.95
H48026	Tip Ø1.50mm (Grey)	EACH	£2.95
H48021	Tip, Concave (Blue)	EACH	£2.95
H48022	Tip, Flat (Brass)	EACH	£2.95



Hand Fitting (Watch), Bergeon Swiss



Bergeon 7404 - Swiss Made

Make hand fitting easy, with maximum control and accuracy.

- Set of 3 tools, with or without base
- Individuals available separately
- Length 115mm
- Diameter Ø6mm
- Knureld handles

Sets contain:

- Bergeon 7404.1 (Grey Handle) Ø0.50 & Ø1.00mm
- Bergeon 7404.2 (Black Handle) Ø0.80 & Ø1.50mm
- Bergeon 7404.3 (Red Handle) Flat brass & Concave blue for centre positioning

Code	Description	UOM	Price
H40485	Set of 3 with Base, Bergeon 7404.503	PACK*3	£53.50
H20057	Set of 3 in Box, Bergeon 7404	PACK*3	£37.95
H0773	Single Ø0.50 & Ø1.00mm (white & black)	EACH	£13.75
H46470	Single Ø0.80 & Ø1.50mm (red & grey)	EACH	£13.75
H46471	Single Flat & Concave (Brass & Blue)	EACH	£13.75
H48041	Tip Ø0.50mm (White)	EACH	£2.95
H48042	Tip Ø0.80mm (Red)	EACH	£2.95
H48043	Tip Ø1.00mm (Black)	EACH	£2.95
H48044	Tip Ø1.50mm (Grey)	EACH	£2.95
H48045	Tip, Concave (Blue)	EACH	£2.95
H48046	Tip, Flat (Brass)	EACH	£2.95

Hand Fitting (Watch), Bergeon Swiss Ergonomic



Bergeon 8404-S04 - Swiss Made - Ergonomic

Make hand fitting easy, with maximum control and accuracy.

- Set of 4
- Knurled handles
- With rotating heads for an easy indexing of the hands
- Tips in synthetic material

- Supplied with smart & handy base
- Colour coded
- For spare tips see from our code H40526

Sizes:

- Grey: Ø0.60mm hole
- Red: Ø1.52mm hole
- Yellow: Ø1.60mm hole
- Blue: Ø1.50mm Flat

Code	Description	UOM	Price
H40484	Bergeon Hand Fitting Tool, Pack*4 & Base	PACK*4	£137.50

Hand Fitting (Watch), Horotec Swiss



Horotec Swiss - Delrin Tips

Make hand fitting easy, with maximum control and accuracy. Thanks to their plastic ends, these tools are ideal to insert watch hands without scratching the dial. Two different hole diameters per tool available to ensure a perfect fit.

Aluminium handles in attractive red anodised finish. Spare tips available.

Individual or Set of 4 tools:

- Flat (without hole) & Ø0.80mm (blue & yellow)
- Ø0.50 & Ø1.00mm (white & black)
- Ø0.65 & Ø1.10mm (blue & black)
- Ø1.50 & Ø2.00mm (black & red)
- Swiss made

Code	Description	UOM	Price
H48029	Set of 4, Horotec Swiss	PACK*4	£30.50
H56223	Set of 4, Horotec Swiss in Wooden Box	EACH	£59.95
H48030	Single Flat (without hole) & Ø0.80mm (blue & yellow)	EACH	£9.50
H48033	Single Ø0.50 & Ø1.00mm (white & black)	EACH	£9.50
H48036	Single Ø0.65 & Ø1.10mm (blue & black)	EACH	£11.75
H19819	Single Ø1.50 & Ø2.00mm (black & red)	EACH	£8.85
H48031	Tip, Flat (Blue)	EACH	£2.45
H48034	Tip Ø0.50mm (White)	EACH	£2.45
H48037	Tip Ø0.65mm (Blue)	EACH	£4.75
H48032	Tip Ø0.80mm (Yellow)	EACH	£2.45
H48035	Tip Ø1.00mm (Black)	EACH	£2.45
H48038	Tip Ø1.10mm (Black)	EACH	£4.95
H48039	Tip Ø1.50mm (Black)	EACH	£1.75
H48040	Tip Ø2.00mm (Red)	EACH	£1.75

Hand Fitting (Watch) Stakes & Base

- Set of 9 presses & handle
- 9 different sizes: Flat x 2, Ø0.80, 0.90, 1.00, 1.10, 1.20, 1.30, 1.50mm
- Value item
- Plastic handle
- Stainless steel base
- Made in India

VALUE



Code	Description	UOM	Price
H39644	Hand Fitting Tool	EACH	£7.95

Hand Fitting (Watch) Stakes & Base, Bergeon Swiss

Bergeon 5378 - Swiss Made

- With 8 stakes and holder spindle on nickel base
- Diameter 50 mm
- Stake sizes: Ø0.30, 0.50, 0.70, 1.15, 1.50 and 1.70mm



Code	Description	UOM	Price
H0774	Bergeon Hand Fitting Tool, 8 Stakes & Base	EACH	£51.95

Hand Fitting & Movement Holder

Bergeon 5409 - Swiss Made

The plate is engraved with circles to facilitate centring the movement on the rest rod. This plate is sustained by a spring and adjusts to the required height automatically.



- Universal movement holder and hand fitting

Code	Description	UOM	Price
M0985	Hand Fitting & Movement Holder	EACH	£76.95

HAND (WATCH) HOLDING TOOLS

Hand Holding (Watch)

Watch Hand Holding

A selection of watch hand holding tools used to hold watch hands while broaching, drilling the holes or filing hands shorter. Spring loaded for quick release and holding, steel construction and polished finished with a knurled handle and 10 holes.

Perfect for holding onto hands or other small parts.

Watch Hand Holding Tool, Indian

An Indian made watch hand holding tool excellently made and at an economy price useful for general purpose main stream watches.

- Indian



Code	Description	UOM	Price
H34932	Watch Hand Holding Tool, Indian	EACH	£4.95

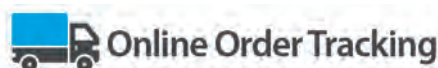

Watch Hand Holding Tweezers, Bergeon



The watch hand holding tweezers are handy little devices quickly holding your watch hands to work on and perfect for broaching.

- Bergeon 30004
- Pair of brass tweezers for holding hands while broaching, filing etc.
- In nickel-plated brass

Code	Description	UOM	Price
T1793	Watch Hand Holding Tweezers, Bergeon	EACH	£42.95

HAND (WATCH) REMOVING LEVERS

Hand Removing & Hairspring Levers, Bergeon Swiss



Bergeon 30020 - Swiss Made

The top quality collection of hand held levers for removing watch and clock hands, plus for turning & setting & reaming watch hairspring Collets.

- Assortment of Levers
- Wooden Case
- Avoid potential damage
- Bergeon Swiss

Contents:

- For turning & setting hairspring collets
- Bergeon 30019-P: Hole Ø0.45mm x Exterior Ø1.20mm
- Bergeon 30017-G: Hole Ø0.70mm x Exterior Ø1.80mm

Broaches for hairspring collets

- Bergeon 30015-P: Ø0.40 to Ø0.90mm
- Bergeon 30015-G: Ø0.70 to Ø1.25mm

Pairs of levers for hairspring collets

- Bergeon 30013: width 1.70mm, length 105mm
- Bergeon 30014: width 2.50mm, length 105mm

Pairs of levers for hands

- Bergeon 30011: width 7mm, length 105mm
- Bergeon 30012: width 9mm, length 105mm

Code	Description	UOM	Price
H0779	Assortment of Levers, Bergeon 30020	PACK*12	£256.50

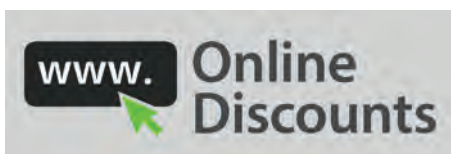

Hand Removing Levers, Bergeon Swiss

Bergeon Swiss Made

The hardened steel specular polish work surfaces with perfectly formed notches make it easier the positioning for the quick and easy removal of watch hands. Ideal for use in conjunction with our dial protectors.

2.5mm Wide, Bergeon 30018-1 by Petitpierre



Bergeon 30018-1 - Swiss Made

Front part in hardened steel with notch to make easier the positioning. Mirror finished tips with anodized aluminum handles.

- Tip width: 2.5mm
- Tip edge thickness: 0.15mm
- Lever's angle 70 °
- Length: 105mm
- Weight 7g

Code	Description	UOM	Price
L19456	2.5mm Wide, Bergeon 30018-1 by Petitpierre	PAIR	£109.75

2.5mm Wide, Bergeon 30019



Bergeon 30019 - Swiss Made

In hardened steel with notch to make easier the positioning. Mirror finished tips with knurled handles.

- Tip width: 2.5mm
- Tip edge thickness: 0.20mm
- Length: 110mm
- Weight 16gm

Code	Description	UOM	Price
H46467	2.5mm Wide, Bergeon 30019	PAIR	£45.95

3mm Wide, Bergeon 5431



Bergeon 5431 - Swiss Made

Hardened steel mirror finished tips with black plastic handles.

- Tip width: 3mm
- Length: 90mm
- Weight 13gm

Code	Description	UOM	Price
H0776	3mm Wide, Bergeon 5431	PAIR	£37.95



7mm Wide, Bergeon 30011



Bergeon 30011 - Swiss Made

In hardened steel with notch to make easier the positioning. Mirror finished tips with knurled handles.

- Tip width: 7mm
- Length: 105mm
- Weight 22gm

Code	Description	UOM	Price
H0777	7mm Wide, Bergeon 30011	PAIR	£56.95

9mm Wide, Bergeon 30012



Bergeon 30012 - Swiss Made

In hardened steel with notch to make easier the positioning. Mirror finished tips with knurled handles.

- Tip width: 9mm
- Length: 105mm
- Weight 24gm

Code	Description	UOM	Price
H0778	9mm Wide, Bergeon 30012	PAIR	£62.95

Hand Removing Levers, Cousins



Cousins - Made in Korea

For the quick and easy removal of watch hands. Ideal for use in conjunction with our dial protectors

- Hardened & polished tips
- Tip width 2mm
- Tip angle 70 °
- Tip thickness 2.2mm
- Overall length 100mm
- Elastomer coated handles
- Made in Korea

Code	Description	UOM	Price
H55418	Watch Hand Removing Levers, Cousins	PACK*2	£19.95

Hand Removing Levers, Horotec Swiss

Horotec - Swiss Made

- 05.009 (1mm) for sweep seconds and small subsidiary hands
- 05.007 (2.5mm) for wrist watches
- 05.008 (4mm) for pocket watches
- 05.014 (10mm) for alarm and wall clocks

Hand levers (pairs) with varnished aluminium handles. Ideal for use in conjunction with our dial protectors.

- Avoid potential damage
- With Varnished Aluminium Handles
- Various tip widths
- Lengths 105 & 115mm

1mm Wide, Horotec 05.009



Horotec 05.009 - Swiss Made

Pair of hand levers with varnished aluminium handles for sweep seconds hands and small counter hands of chronometers. Delivered with 2 dial protectors Horotec 70.004.

- Avoid potential damage
- For Sweep Second and Small Counter Hands for Chronometers
- With Varnished Aluminium Handles
- Tip width 1mm
- Length 105mm

Code	Description	UOM	Price
H32670	1mm Wide, Horotec 05.009	PAIR	£18.95

2.5mm Wide, Horotec 05.007



Horotec 05.007 - Swiss Made

Pair of hand levers with varnished aluminium handles for wrist watches. Delivered with 2 dial protectors Horotec 70.004.

- Avoid potential damage
- For wrist watches
- With Varnished Aluminium Handles
- Tip width 2.5mm
- Length 105mm

Code	Description	UOM	Price
H48219	2.5mm Wide, Horotec 05.007	PAIR	£19.85

4mm Wide, Horotec 05.008



Horotec 05.008 - Swiss Made

Pair of hand levers with varnished aluminium handles for pocket watches. Delivered with 2 dial protectors Horotec 70.004.

- Avoid potential damage
- For pocket watches
- With Varnished Aluminium Handles
- Tip width 4mm
- Length 105mm

Code	Description	UOM	Price
H48220	4mm Wide, Horotec 05.008	PAIR	£19.85

10mm Wide, Horotec 05.014



Horotec 05.014 - Swiss Made

Pair of hand levers with varnished aluminium handles for alarm & wall clocks. Delivered with 2 dial protectors Horotec 70.004.

- Avoid potential damage
- For pocket watches
- With Varnished Aluminium Handles
- Tip width 10mm
- Length 115mm

Code	Description	UOM	Price
H48221	10mm Wide, Horotec 05.014	PAIR	£39.95

Hand Removing Levers, Non Swiss

VALUE



Watch Hand Removing Levers

For the quick and easy removal of watch hands. Ideal for use in conjunction with our dial protectors.

- Lever action
- Avoid potential damage
- Made India

Code	Description	UOM	Price
H39643	Indian, 2.5mm Width	PAIR	£2.25

HAND (WATCH) REMOVING TOOLS

Hand Removing Tools (Watch), Bergeon



Watch Hand Removing - Bergeon Swiss

Bergeon PRESTO hand removers for wrist watches equipped with buffer to avoid damaging the dial.

- Wrist watch hand removers
- Cannon pinion removers
- Pocket watch hand removers
- Multi-spoke hand removers
- Second hand removers
- Non dial touch removers
- Alarm clocks & Timers

Bergeon 30636.1, Watch Hands

Bergeon 30636.1 - "Presto" Tools

- Hand remover for wrist watches
- Tips will not damage the dial
- Black handle

Code	Description	UOM	Price
H0784	Bergeon 30636.1, Watch Hands	EACH	£32.75



Bergeon 30637.2, Cannon Pinions & Pocket Watch Hands

Bergeon 30637.2 - "Presto" Tools

- For removing cannon pinions and hands of large watches
- Stronger
- Green handle



Code	Description	UOM	Price
H0783	Bergeon 30637.2, Cannon Pinions & Pocket Watch Hands	EACH	£38.75

Bergeon 30669.4, Alarm Clocks & Timers

Bergeon 30669.4 - "Presto" Tools

- For alarm clocks, timers and other instruments
- Strong tool with different spokes diam. 0.70 - 0.90 - 1.20 - 1.40 mm
- Violet handle



Code	Description	UOM	Price
H0782	Bergeon 30669.4, Alarm Clocks & Timers	EACH	£44.95

Bergeon 30670.6, Watch Seconds Hands

Bergeon 30670.6 - "Presto" Tools

- Second hand remover
- Excellent for curved countersink dials
- White handle



Code	Description	UOM	Price
H0786	Bergeon 30670.6, Watch Seconds Hands	EACH	£35.95

Bergeon 30671.7, Watch hands, No Touch

Bergeon 30671.7 - "Presto" Tools

- Hand remover that removes hands without touching the dial
- For curved dials, stop watches & movements without dials
- Points: Ø0.20 - 0.65 - 0.90 - 1.15 mm



Code	Description	UOM	Price
H0785	Bergeon 30671.7, Watch hands, No Touch	EACH	£42.95

Online Order Tracking

ALL FEEDBACK WELCOME

Hand Removing Tools (Watch), Cousins

Hand Remover, Cousins

- Hands, cannon pinions, sweep wheels and chronograph driving wheel remover
- Hand remover for wrist watches
- Tips will not damage the dial
- Black handle
- Made in China



Code	Description	UOM	Price
H37692	Hand Remover, Cousins	EACH	£9.75

Hand Removing Tools (Watch), Horotec



Watch Hand Removing - Horotec Swiss

- Remove delicate watch hands without touching the dial
- 3 pins: Ø0.15, 0.60 & 1.00mm
- 3 slotted hand extractors: Ø0.60, 1.45 & 2.10mm
- Powder coated steel base
- Stainless steel handle, pins and extractors
- Knurled handle
- Horotec 05.125

How to use:

- Insert the pin, followed by the extractor into the bottom of the handle
- Twist the red knurled handle top to move the pin up and down
- Lift the hands off when the pin and extractor are in place

Code	Description	UOM	Price
H53182	Hand Removing Tool, Horotec 05.125	EACH	£249.95
H53187	Hand Extractor, Ø0.60mm	EACH	£69.95
H53188	Hand Extractor, Ø1.45mm	EACH	£69.95
H53189	Hand Extractor, Ø2.10mm	EACH	£69.95
H53184	Pin Ø0.15mm	EACH	£17.65
H53185	Pin Ø0.60mm	EACH	£17.65
H53186	Pin Ø1.00mm	EACH	£17.65

Hand Removing Tools (Watch), Indian

Hand Remover, Indian

- Hands lifting tool
- Hand remover for wrist watches
- Traditional style of removing hands
- Made in India



Code	Description	UOM	Price
H37864	Hand Remover, Indian	EACH	£3.25

WATCH MOVEMENT SPECIFIC

AUTOMATIC ROTOR WEIGHT BOLT TOOLS

Multi-Collet (Various Calibres), Bergeon



Oscillating Rotor Weight Lock & Release Tool - Multi-Collet - Bergeon

- Bergeon 6923
- To release and lock the oscillating weight (rotor)
- Two heads included
- Head (A) - Ø10.30mm For ETA 2890 series, including 2892, 2893, 2894, 2895, 2896 & 2897
- Head (B) - Ø7.00mm For Valjoux 7750 & 7770 Valgrange A07111, A07161 & A07271
- Heads also available separately

Video Link: Oscillating Rotor Weight Lock & Release Tool

Code	Description	UOM	Price
W15208	Multi-Collet (Various Calibres), Bergeon	EACH	£109.95
W40006	Head A - ETA 2890 Series	EACH	£37.85
W40007	Head B - Valjoux 7750, 7770 & ETA A07 Series	EACH	£37.85

Rolex Oscillating Rotor Weight Axle Punches

See Page 1153

Multi-Collet (Various Calibres), Horotec



Horotec 03.675 - Swiss Made

Tool for assembling/disassembling weight bolts.

- To release and lock the oscillating weight (rotor)
- Two heads included
- For ETA 2890 series, including 2892, 2893, 2894 & 2895
- ETA 2000.1
- Valjoux 7750 & 7770, Valgrange A07111, A07161 & A07271

Code	Description	UOM	Price
W18532	Multi-Collet (Various Calibres), Horotec	EACH	£69.75

BALANCE & ESCAPEMENT

Balance Holding Tool

- Bergeon 7990
- Support for cleaning the impulse pin
- Holds the balance without damaging the hairspring
- No need to remove the balance bridge
- Diameter: Ø25mm
- Tapered slot, from Ø5 to Ø9mm wide



Code	Description	UOM	Price
B39562	Balance Holding Tool	EACH	£12.95

Balance & Hairspring Holding Tool

- Bergeon 30106
- Diameter: 35 mm
- With holes diameter 0.60mm to 2.80mm
- Tapered slot
- In nicked brass



Code	Description	UOM	Price
B0040	Balance & Hairspring Holding Tool	EACH	£29.95

Balance Cock Curving Tool



- Bergeon 5432A
- Balance Cock Curving Tool

Code	Description	UOM	Price
B0039	Balance Cock Curving Tool, Bergeon 5432A	EACH	£58.95

ORDER tracking

ONLINE QUOTES

ONLINE F.A.Q.

CUSTOMER SERVICE SECOND TO NONE

Balance Cylinder Removal Punches



- Bergeon 6581
- Punches to remove watch balance cylinders
- Ø0.60, 0.70, 0.80 & 0.90mm
- Overall length 85mm
- Pack*4
- Swiss made

Code	Description	UOM	Price
B49887	Punches to Unplug Cylinders, Bergeon Swiss	PACK*4	£38.95

Balance Hairspring Collet Tightening and Reaming Tool

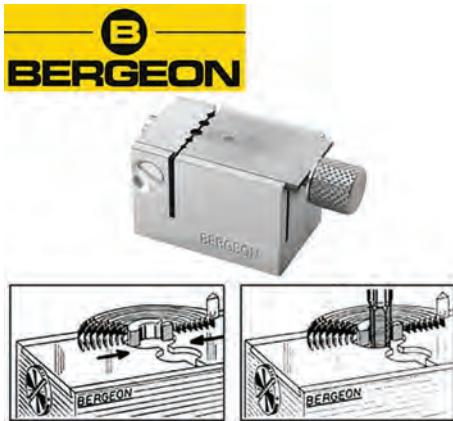

With 5 different notches for tightening all sizes of hairspring collets and for reaming.

- Bergeon 3007
- 70g

Code	Description	UOM	Price
C22531	Balance Hairspring Collet Tightening and Reaming Tool	EACH	£99.95

Balance Bridge Holding Tool



Simple but practical

To hold the wristwatch balance bridge (via the bridge screw hole) for inspection and correction of the hairspring whilst avoiding polluting the staff with oil.

- For holding bridge with balance attached while putting it in beat
- Straightening kinks in hairsprings
- Under-cutting screws
- Removing or adding timing washers, etc.

- Bergeon Swiss or unbranded

Code	Description	UOM	Price
B15259	Balance Hairspring Holding Tool	EACH	£3.75
S44355	Balance Bridge Holding Tool, Bergeon Swiss	EACH	£16.75

Balance Screw Holders, Set



Ideal tool for holding and removing watch balance screws after they have been loosened with a screwdriver. Also allows adjustments and inspection without removing the screw from the holder.

- Bergeon 2565
- Set of 8
- With sliding grips
- Overall length 100mm
- Sizes include: Ø0.25, 0.30, 0.35, 0.40, 0.45, 0.50, 0.60 & 0.70mm
- Excellent for balance & small screws

Individual Replacement Sizes Available.

Code	Description	UOM	Price
B4180	Balance Screw Holder Set, Bergeon	PACK*8	£249.95
B0042A	Ø.30mm Balance Screw Holder, Bergeon	EACH	£41.95
B0042B	Ø.35mm Balance Screw Holder, Bergeon	EACH	£41.95
V39479	Universal (fine tip) Balance Screw Holder, India	EACH	£1.95

Balance Staff Pivot Straightening Tool



Seitz Precision Tool for Straightening Balance Staff Pivots

Allows the pivots to be straightened without breaking due to a control device as well as a screw fitted with a stop.

- Bergeon 30350.D.02
- 41 Jewelled Holes
- Ø0.07 - Ø0.15mm
- Progression 0.025mm
- Detailed Operating Instructions

- 100g

Code	Description	UOM	Price
B34575	Seitz Balance Staff Pivot Straightening Tool	EACH	£445.00

Hairspring Holding Pin Vice



- Bergeon 4072
- Pin vice for holding watch balance hairsprings
- Stainless steel
- 105mm overall length
- Made in Switzerland

Code	Description	UOM	Price
P56316	Hairspring Holding Pin Vice, Bergeon 4072	EACH	£32.95

Hairspring Holding Tool



- Bergeon 30105 & 30105A
- Support for holding watch balance hairsprings
- Glass top
- Chromium plated bottom
- Overall diameter Ø35mm
- Either with Ø3.50 or Ø4.50mm centre hole
- Made in Switzerland

Code	Description	UOM	Price
B52887	Ø3.50mm Centre Hole Hairspring Holder	EACH	£59.95
B52888	Ø4.50mm Centre Hole Hairspring Holder	EACH	£59.95

Lever for Hairsprings



Bergeon 5430

- For lifting under the hairspring collet
- 1.80mm tip breadth
- Red plastic handles

Code	Description	UOM	Price
L0902	Lever for Hairsprings	PACK*2	£39.75

Pivot Rounding Tool

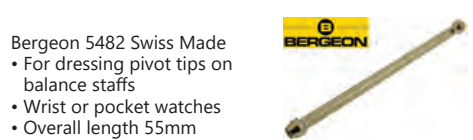

- Bergeon 5482 Swiss Made
- For dressing pivot tips on balance staffs
- Wrist or pocket watches
- Overall length 55mm

Code	Description	UOM	Price
P1227	Pivot Rounding Tool	EACH	£64.75

OVER 130,000 DIFFERENT ITEMS

Poising Tool

- Bergeon 2802-LN-MD
- Extra perfect finish
- High precision
- Spirit level Ø18mm
- Spirit level can be placed on the jaws
- Razor shaped stainless steel jaws
- Jaws 15mm length
- Tool with jaws without notch
- Three adjustable legs

Code	Description	UOM	Price
P1256	Poising Tool, Bergeon 2802-LN-MD	EACH	£385.00

Roller Adjusting Tweezers

- Bergeon 4852
- Tweezers to turn and remove rollers
- Gently grips the roller for repositioning
- Various diameters for all roller sizes
- In nickel plated brass

Code	Description	UOM	Price
R1463	Roller Adjuster Bergeon 4852	EACH	£51.95

Roller Remover

- Gently removes the friction fit roller from the staff, for replacement and repositioning
- V slots between hub of balance staff and seat of roller
- Slight pressure on sides of tool is sufficient to lift roller from balance seat
- Due to the manufacturers finishing the actual roller removing jaws may need filing and burnishing to suit
- Made in India

Code	Description	UOM	Price
R38801	Roller Remover	EACH	£3.50

Roller Remover, Bergeon Swiss

- Bergeon 2810
- Gently removes the friction fit roller from the staff, for replacement and repositioning
- V slots between hub of balance staff and seat of roller
- Slight pressure on sides of tool is sufficient to lift roller from balance seat
- Extra fine jaws permit work on both small and standard sizes

Code	Description	UOM	Price
R1462	Roller Remover, Bergeon Swiss	EACH	£16.75

Roller Remover with Punches, Bergeon Swiss

- Watch balance roller remover with 2 punches
- Punches with Ø0.10 & Ø0.20mm holes
- Stainless steel jaws to hold the balance
- Roller seat fits the V slot jaws & using slight pressure on the punch the roller is removed
- Steel body
- Bergeon 30070
- Swiss made



Code	Description	UOM	Price
R48644	Roller Remover with Punches, Bergeon 30070	EACH	£68.95
R48645	Ø0.10mm Punch	EACH	£10.95
R48646	Ø0.20mm Punch	EACH	£10.95
R48647	Jaw Plate for Roller Remover	EACH	£19.95

Stud Holder Tool

- Bergeon 6887
- Hairspring stud holder tool
- For secure anchoring of the stud during pinning

Code	Description	UOM	Price
S1634	Stud Holders Tool, Bergeon	EACH	£195.00

Truing Calipers

Balance (Escapement) - Truing Calipers

For checking the balance wheel is sitting true on the balance staff. By gently & slowly spinning the balance you can inspect & check to ensure a perfect fit.

Click website "More Information" & "PDF's" for full specification.

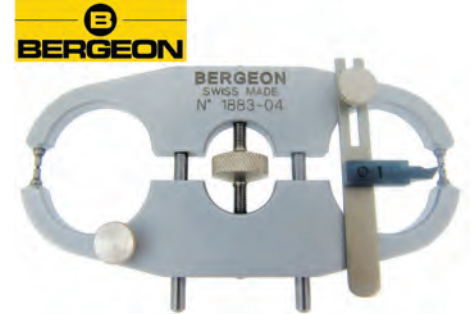
Truing Calipers, Bergeon 1883

- Large model with parallel opening
- With slide, carefully Made
- Pivot protectors in steel
- 1 hole Ø0.15mm
- 1 hole conic.
- Maximum opening 14mm

Code	Description	UOM	Price
C6119	Truing Calipers, Bergeon 1883	EACH	£164.95

Truing Calipers, Bergeon 4000

- Light Type
- For timer
- Pivot protectors in steel
- Simpler alternative to Bergeon 1883
- Maximum opening 11mm

Code	Description	UOM	Price
C0293	Truing Calipers, Bergeon 4000	EACH	£35.75

Truing Calipers, Bergeon 5896

- "Lyre" Truing Caliper
- Brass sanded, chrome plated
- Jewelled pivot protectors
- Holes: Ø0.15mm
- Maximum opening 11mm

Code	Description	UOM	Price
C0294	Truing Calipers, Bergeon 5896	EACH	£57.95

www. Online Discounts

PRICE PROMISE GUARANTEE

BARREL ARBOR TOOLS

Barrel Arbor Holders



- Bergeon 30610 +
- Barrel arbor holder
- Slide locking jaw
- Length 120mm
- Chrome plated bow and handle
- For checking security and condition of watch mainsprings

Code	Description	UOM	Price
B0043E	Ø0.75mm Barrel Arbor Holder	EACH	£41.95
B0043D	Ø1.00mm Barrel Arbor Holder	EACH	£41.95
B0043C	Ø1.25mm Barrel Arbor Holder	EACH	£41.95
B0043B	Ø1.50mm Barrel Arbor Holder	EACH	£41.95
B0043A	Ø1.75mm Barrel Arbor Holder	EACH	£41.95
B50665	Ø2.00mm Barrel Arbor Holder	EACH	£41.95
B50666	Ø2.30mm Barrel Arbor Holder	EACH	£41.95
B50667	Ø2.50mm Barrel Arbor Holder	EACH	£41.95

Barrel Cover Closer Tool



- Simple to use
- Close the barrel cover easily
- Use the same amount of pressure across the circumference
- Avoids damaging the barrel's profile
- Bergeon Swiss (Bergeon 7922), Italian Made or Cousins

Code	Description	UOM	Price
B39009	Barrel Cover Closing Tool, Bergeon Swiss	EACH	£18.50
B49427	Barrel Cover Closing Tool, Cousins	EACH	£6.95
B12036	Barrel Cover Closing Tool, Italian	EACH	£22.95

CANNON PINION TOOLS

Cannon Pinion Remover



Cannon Pinion Remover

- Bergeon 4854
- Can lift cannon pinions diameter Ø1.00 to Ø1.80mm
- With lever and wooden handle
- For small and large watches
- Adapted to all calibres
- To operate, the lever must always be pushed down
- To take apart the tool for cleaning, simply lift the handle up
- Length 130mm

• For further information please see the PDF available

Code	Description	UOM	Price
C0296	Cannon Pinion Remover, Bergeon	EACH	£58.95

Cannon Pinion Tightening Tool, Bergeon 4733



Cannon Pinion Tightening Tool - Bergeon 4733

- Bergeon 4733
- Cannon pinion tightening tool
- Regulated opening system
- Overall length 120mm

Code	Description	UOM	Price
T26446	Cannon Pinion Tightener, Bergeon 4733	EACH	£69.95

Cannon Pinion Tightening Tool, Bergeon 31001

Cannon Pinion Tightening Tool - Bergeon 31001

- Bergeon 31001
- For use with Bergeon jewellery kit (J31073)
- Cannon pinion tightening tool
- Punch diameter Ø4.00mm
- Stake diameter Ø5.00mm

Fit the special punch to the spindle and the special stake to the platform of the jewellery tool. The blades must be exactly opposite each other and the micrometer screw must be set before the work is started.

Items also available individually under item codes: J30587 & J30588

Code	Description	UOM	Price
C4270	Cannon Pinion Tightening Tool, Bergeon	PACK*2	£18.50

IMPROVED SPEED SEARCH

ONLINE F.A.Q.

Cannon Pinion & Pocket Watch Hand Remover

See Page 1132



CIRCUIT WRITER (CONDUCTIVE PAINT)

Conductive Pen



Conductive Pen - To repair defective circuits

- Quickly creates conductive traces on most surfaces
- Easy and economical to use
- Micro-tip for precision application
- Dries in minutes at room temperature
- Single component system
- Good electrical and thermal conductivity

Code	Description	UOM	Price
C12025	Conductive Pen, Etic Swiss	EACH	£31.95

Price breaks available, see website

CROWN REMOVING & WINDING TOOLS

Watch Crown Removing Tools



Bergeon 4344.9 - "Presto" Tools

Removes:

- Hands
- Cannon pinions
- Sweep wheels
- Chronograph driving wheels
- Crown remover for split stems
- Also removes hands and setting knobs on travel alarm-clocks
- Yellow handle

Code	Description	UOM	Price
C0396	Crown & Split Stem Removing Tool	EACH	£34.95

Crown Winder

VALUE



- Plunger opens and closes jaws
- Strong spring action holds button firm while winding
- Save wear and tear on fingers
- Ø4.5 to 6.0mm
- Made in India

Code	Description	UOM	Price
C37925	Crown Winder	EACH	£3.50

Crown Winders, A*F Swiss



- A*F Swiss 117.927
- Plunger opens and closes jaws
- Strong spring action holds button firm while winding
- Save wear and tear on fingers
- Ø3 to 5mm

Code	Description	UOM	Price
B7047	Ø3 to 5mm Watch Crown Winder	EACH	£18.25

Crown Winders, Bergeon Swiss



- Bergeon 30409A, B, C & D
- Plunger opens and closes jaws
- Strong spring action holds button firm while winding
- Save wear and tear on fingers
- To cover crown sizes 2 to 7mm

Code	Description	UOM	Price
B2271	Ø2 to 4mm, Bergeon 30409D	EACH	£24.50
B2268	Ø3 to 5mm, Bergeon 30409A	EACH	£24.50
B2270	Ø4 to 6mm, Bergeon 30409C	EACH	£24.50
B2269	Ø5 to 7mm, Bergeon 30409B	EACH	£24.50

DIAL BOLT TOOLS

Dial Bolt Opener



- Watch dial bolt opener
- Polished mirror tip
- Overall length 100mm
- Horotec 03.016

Code	Description	UOM	Price
D55903	Dial Bolt Opener, Horotec 03.016	EACH	£16.95



DIAL PROTECTORS & SUPPORTS

Dial Protectors & Supports

Dial Protectors & Supports

- Protects the dial whilst removing hands
- Ensures no scratches, marks or blemishes whilst watch is being worked on
- Bergeon Swiss or Horotec Swiss

For specifications see additional information

Plastic Dial Protectors, Bergeon Swiss



- Bergeon 6938
- 5 pieces
- Resistant synthetic material
- Soft non snap plastic
- Thickness 0.15mm
- Colour grey

Code	Description	UOM	Price
D19414	Plastic Dial Protectors, Bergeon Swiss	PACK*5	£3.25

Plastic Dial Protectors, Horotec Swiss



- Horotec 70.004
- Pack*10

Code	Description	UOM	Price
D46259	Plastic Dial Protectors, Horotec Swiss	PACK*10	£2.50

Dial Supports

- Bergeon 7153
- Many small holes allowing an easy and simple positioning of the dial feet
- Practical base for all types of Dial Plates.
- In synthetic Material
- Ø50mm
- 8mm Thick



Code	Description	UOM	Price
D32159	Dial Support, Bergeon Swiss	EACH	£42.95

ETACHRON SPECIFIC

ETACHRON Stud Removing Screwdriver



ETACHRON Stud Removing Screwdriver

- Fork type end for removing the stud from the stud support
- Screwdriver style tool
- Knurled handle
- Swivel octagonal head
- Bergeon 30081.EETC

Code	Description	UOM	Price
S51732	Screwdriver for Removing ETACHRON Studs	EACH	£19.95

ETACHRON Stud Removing Tools

Bergeon Swiss, Tool For Removing ETACHRON Studs



- Bergeon 6919
- Hand held tool for removing the studs on ETACHron

Code	Description	UOM	Price
E20151	Bergeon Swiss, Tool For Removing ETACHRON Studs	EACH	£24.50

Horotec Swiss, Tool For Removing ETACHRON Studs



- Horotec 03.015
- Hand held tool for removing the studs on ETACHron

Code	Description	UOM	Price
N48238	Horotec Swiss, Tool For Removing ETACHRON Studs	EACH	£17.95

Barrel Cover Closer Tool

See Page 1136



ETACHRON Stud Turning Screwdriver



ETACHRON Stud Turning Tools

- Screwdriver style tool
- Knurled handle
- Swivel octagonal head
- Bergeon 30081.TETC

Code	Description	UOM	Price
S51733	Screwdriver for Turning ETACHRON Studs	EACH	£19.95

ETA Special Tools



ETACHRON Stud Turning Tools

- Hand held tool for turning studs and balance spring buckles for ETACHRON
- Horotec Swiss

Code	Description	UOM	Price
E53181	Horotec Swiss, Tool for Turning ETACHROM Studs	EACH	£21.75

JEWELLING TOOLS (BERGEON, KIF, INCA, NOVODIAC & SEITZ)

Bergeon Jewelling Tools

Pallet Alignment Tool, Bergeon



- Bergeon 2229.03
- This precision instrument enables micrometric adjustment of pallet stone position for length, lift,

angle etc. prior to fixing - no need to remove staff and greatly simplifies this very exacting task.

Code	Description	UOM	Price
E9511	Pallet Alignment Tool. Bergeon 2229.03	EACH	£785.00

Pallet Fork Burnisher, Bergeon



- Bergeon 4847
- Swiss Made
- Pallet fork burnisher double ended
- One end to polish the fork notch
- Other to polish inside the horns

Code	Description	UOM	Price
B21024	Pallet Fork Burnisher, Bergeon	EACH	£72.95

Horia Jewelling Tools

Horia Jewelling Tool

Horia Jewelling Tool

- Horia Swiss jewellery tool
- With micrometric screw for rectifying end shakes
- Horia 61.01.03/61.01.04
- Bergeon 5372.61/5372.61.4

- Dimensions:
- 80 x 45 x 120mm (length x width x height)
 - 25mm maximum opening
 - Table Ø20mm

- Two versions available:
- Ø3mm spindle fitting version has a spindle (top half) fitting of Ø3mm & a table fitting (bottom half) of Ø4mm
 - Ø4mm spindle fitting version has a spindle (top half) fitting of Ø4mm & a table fitting (bottom half) of Ø4mm
 - Ø3mm replacement spindle available, also converts a Ø4mm press to a Ø3mm press
 - Ø4mm replacement spindle available, also converts a Ø3mm press to a Ø4mm press

Code	Description	UOM	Price
J50541	Ø3mm Spindle Fitting Horia Jewelling Tool	EACH	£415.00
J50542	Ø4mm Spindle Fitting Horia Jewelling Tool	EACH	£415.00
J52229	Ø3mm Spindle (Converts Ø4mm Press to Ø3mm Press)	EACH	£79.95
J52138	Ø4mm Spindle (Converts Ø3mm Press to Ø4mm Press)	EACH	£79.95



Horia Jewelling Tool with Lever Press



Horia Jewelling Tool with Lever Press

- Horia Swiss jewellery tool
- With micrometric screw for rectifying end shakes
- With lever press
- Horia 63.03.01/63.04.01
- Bergeon 5373.63/5373.63.4

- Dimensions:
- 95 x 50 x 125mm (length x width x height)
 - 30mm maximum opening
 - Table Ø20mm

- Two versions available:
- Ø3mm spindle fitting version has a spindle (top half) fitting of Ø3mm & a table fitting (bottom half) of Ø4mm
 - Ø4mm spindle fitting version has a spindle (top half) fitting of Ø4mm & a table fitting (bottom half) of Ø4mm
 - Ø3mm replacement spindle available, also converts a Ø4mm press to a Ø3mm press
 - Ø4mm replacement spindle available, also converts a Ø3mm press to a Ø4mm press

Code	Description	UOM	Price
J50543	Ø3mm Spindle Fitting Horia Jewelling Tool with Lever Press	EACH	£439.95
J50544	Ø4mm Spindle Fitting Horia Jewelling Tool with Lever Press	EACH	£439.95
J52230	Ø3mm Spindle (Converts Ø4mm Press to Ø3mm Press)	EACH	£94.95
J52225	Ø4mm Spindle (Converts Ø3mm Press to Ø4mm Press)	EACH	£94.95

Assortment, 8 Pump Pushers & 3 Anvils



Horia Jewelling Assortment

- 8 pump pushers: Ø0.65, 0.75, 0.85, 0.95, 1.05, 1.15, 1.25 & 1.35mm
- 3 anvils: Ø1.00, 1.30 & 2.00mm
- Either for Ø3mm spindle fitting tool or Ø4mm spindle fitting tool
- Horia AS01.03/AS01.04

SAME DAY DISPATCH

ORDER tracking

WORLDWIDE DELIVERY

• Bergeon 5374.A/5374.A4

Code	Description	UOM	Price
J50545	Ø3mm Spindle Fitting Assortment	PACK*11	£181.50
J50546	Ø4mm Spindle Fitting Assortment	PACK*11	£181.50

Assortment, 12 Pump Pushers & 6 Anvils



Horia Jewelling Assortment

- 12 pump pushers: Ø0.65, 0.75, 0.85, 0.95, 1.05, 1.15, 1.25 & 1.35, 1.45, 1.55, 1.65 & 1.75mm
- 6 anvils
- Either for Ø3mm spindle fitting tool or Ø4mm spindle fitting tool
- Horia AS03.03/AS03.04
- Bergeon 5374.B/5374.B4

Code	Description	UOM	Price
J50547	Ø3mm Spindle Fitting Assortment	PACK*18	£315.00
J50548	Ø4mm Spindle Fitting Assortment	PACK*18	£325.00

Assortment, 15 Pump Pushers, 15 Anvils, Pallet Staff Pusher & Guard Pin Pusher



Horia Jewelling Assortment

- 15 pump pushers: Ø0.55, 0.65, 0.75, 0.85, 0.95, 1.05, 1.15, 1.25, 1.35, 1.45, 1.55, 1.65 & 1.85, 2.05 & 2.35mm
- 15 anvils
- Pallet staff pusher & anvil
- Guard pin pusher & anvil
- Either for Ø3mm spindle fitting tool or Ø4mm spindle fitting tool
- Horia AS02.03/AS02.04
- Bergeon 5374.C/5374.C4

Code	Description	UOM	Price
J50549	Ø3mm Spindle Fitting Assortment	PACK*34	£565.00
J50550	Ø4mm Spindle Fitting Assortment	PACK*34	£565.00

Assortment, 24 Pump Pushers & 24 Anvils



Horia Jewelling Assortment

- 24 pump pushers: Ø0.65, 0.75, 0.85, 0.95, 1.05, 1.15, 1.25, 1.35, 1.45, 1.55, 1.65, 1.75, 1.85, 1.95, 2.05, 2.15, 2.25, 2.35, 2.45, 2.55, 2.65, 2.75, 2.85 & 2.95mm
- 24 anvils
- Either for Ø3mm spindle fitting tool or Ø4mm spindle fitting tool
- Horia AS04.03/AS04.04
- Bergeon 5374.D/5374.D4

Code	Description	UOM	Price
J50551	Ø3mm Spindle Fitting Assortment	PACK*48	£650.00
J50552	Ø4mm Spindle Fitting Assortment	PACK*48	£650.00

Anvils By Size



Horia Anvils by Size

- Horia Anvils by Size
- Individual anvils
- Ø4mm fitting (for jewellery tool table)
- Fits either size Horia tool
- Horia 1100.XX
- Bergeon 5374.E

Code	Description	UOM	Price
J50625	Ø1.50mm Anvil	EACH	£16.95
J50603	Ø1.80mm Anvil	EACH	£16.95
J50604	Ø1.90mm Anvil	EACH	£16.95
J50605	Ø2.00mm Anvil	EACH	£16.95
J50606	Ø2.10mm Anvil	EACH	£16.95
J50607	Ø2.20mm Anvil	EACH	£16.95
J50608	Ø2.40mm Anvil	EACH	£16.95
J50609	Ø2.50mm Anvil	EACH	£16.95
J50610	Ø2.70mm Anvil	EACH	£16.95
J50611	Ø2.90mm Anvil	EACH	£16.95
J50612	Ø3.00mm Anvil	EACH	£16.95
J50613	Ø3.20mm Anvil	EACH	£16.95
J50614	Ø3.30mm Anvil	EACH	£16.95
J50615	Ø3.40mm Anvil	EACH	£16.95
J50616	Ø3.50mm Anvil	EACH	£16.95
J50617	Ø3.60mm Anvil	EACH	£16.95
J50618	Ø3.80mm Anvil	EACH	£16.95
J50619	Ø4.00mm Anvil	EACH	£49.95
J50620	Ø4.10mm Anvil	EACH	£16.95
J50621	Ø4.20mm Anvil	EACH	£16.95
J50622	Ø4.30mm Anvil	EACH	£16.95
J50623	Ø4.40mm Anvil	EACH	£16.95
J50624	Ø4.50mm Anvil	EACH	£16.95

Guard Pin Pusher & Anvil

Horia Guard Pin Pusher & Anvil

- Guard Pin Pusher & Anvil
- Either for Ø3mm spindle fitting tool or Ø4mm spindle fitting tool
- Horia 1410.03/1410.04
- Bergeon 2237.3/2237.4



Code	Description	UOM	Price
J50628	Ø3mm Fitting Guard Pin Pusher & Anvil	EACH	£64.95
J50629	Ø4mm Fitting Guard Pin Pusher & Anvil	EACH	£64.95

Pallet Staff Pusher & Anvil

Horia Pallet Staff Pusher & Anvil

- Pallet Staff Pusher & Anvil
- Anvil Ø1.50mm
- Pusher Ø0.80mm
- Either for Ø3mm spindle fitting tool or Ø4mm spindle fitting tool
- Horia 1400.03/1400.04
- Bergeon 2238.3/2238.4



Code	Description	UOM	Price
J50626	Ø3mm Fitting Pallet Staff Pusher & Anvil	EACH	£44.50
J50627	Ø4mm Pallet Staff Pusher & Anvil	EACH	£44.50

Pump Pushers by Size (Ø3mm Fitting)

Pump Pushers by Size

- Horia Pump Pushers by Size
- Individual pump pushers
- Ø3mm fitting
- Fits size Horia tools J50541 & J50543
- Horia 1020.03
- Bergeon 5374.F



Code	Description	UOM	Price
J50553	Ø0.55mm Pump Pusher	EACH	£22.25
J50554	Ø0.65mm Pump Pusher	EACH	£22.25
J50555	Ø0.75mm Pump Pusher	EACH	£22.25
J50556	Ø0.85mm Pump Pusher	EACH	£22.25
J50557	Ø0.95mm Pump Pusher	EACH	£22.25
J50558	Ø1.05mm Pump Pusher	EACH	£22.25
J50559	Ø1.15mm Pump Pusher	EACH	£22.25
J50560	Ø1.25mm Pump Pusher	EACH	£22.25
J50561	Ø1.35mm Pump Pusher	EACH	£22.25
J50562	Ø1.45mm Pump Pusher	EACH	£22.25
J50563	Ø1.55mm Pump Pusher	EACH	£22.25
J50564	Ø1.65mm Pump Pusher	EACH	£22.25
J50565	Ø1.75mm Pump Pusher	EACH	£22.25
J50566	Ø1.85mm Pump Pusher	EACH	£22.25
J50567	Ø1.95mm Pump Pusher	EACH	£22.25
J50568	Ø2.05mm Pump Pusher	EACH	£22.25
J50569	Ø2.15mm Pump Pusher	EACH	£22.25
J50570	Ø2.25mm Pump Pusher	EACH	£22.25
J50571	Ø2.35mm Pump Pusher	EACH	£22.25
J50572	Ø2.45mm Pump Pusher	EACH	£22.25
J50573	Ø2.55mm Pump Pusher	EACH	£22.25
J50574	Ø2.65mm Pump Pusher	EACH	£22.25
J50575	Ø2.75mm Pump Pusher	EACH	£22.25
J50576	Ø2.85mm Pump Pusher	EACH	£22.25
J50577	Ø2.95mm Pump Pusher	EACH	£22.25

Pump Pushers by Size (Ø4mm Fitting)

Pump Pushers by Size

- Horia Pump Pushers by Size
- Individual pump pushers
- Ø4mm fitting
- Fits size Horia tools J50542 & J50544
- Horia 1020.04
- Bergeon 5374.F4



Code	Description	UOM	Price
J50578	Ø0.55mm Pump Pusher	EACH	£32.95
J50579	Ø0.65mm Pump Pusher	EACH	£21.95
J50580	Ø0.75mm Pump Pusher	EACH	£21.95
J50581	Ø0.85mm Pump Pusher	EACH	£21.95

J50582	Ø0.95mm Pump Pusher	EACH	£21.95
J50583	Ø1.05mm Pump Pusher	EACH	£21.95
J50584	Ø1.15mm Pump Pusher	EACH	£21.95
J50585	Ø1.25mm Pump Pusher	EACH	£21.95
J50586	Ø1.35mm Pump Pusher	EACH	£21.95
J50587	Ø1.45mm Pump Pusher	EACH	£21.95
J50588	Ø1.55mm Pump Pusher	EACH	£21.95
J50589	Ø1.65mm Pump Pusher	EACH	£21.95
J50590	Ø1.75mm Pump Pusher	EACH	£21.95
J50591	Ø1.85mm Pump Pusher	EACH	£21.95
J50592	Ø1.95mm Pump Pusher	EACH	£21.95
J50593	Ø2.05mm Pump Pusher	EACH	£21.95
J50594	Ø2.15mm Pump Pusher	EACH	£21.95
J50595	Ø2.25mm Pump Pusher	EACH	£21.95
J50596	Ø2.35mm Pump Pusher	EACH	£21.95
J50597	Ø2.45mm Pump Pusher	EACH	£21.95
J50598	Ø2.55mm Pump Pusher	EACH	£21.95
J50599	Ø2.65mm Pump Pusher	EACH	£21.95
J50600	Ø2.75mm Pump Pusher	EACH	£21.95
J50601	Ø2.85mm Pump Pusher	EACH	£21.95
J50602	Ø2.95mm Pump Pusher	EACH	£21.95

Inca Jewelling Tools

Incabloc Punch & Stake Set



Incabloc - Swiss Made

Set of 6 punches and 7 stakes. Specially adapted to the different dimensions of the Incabloc shock absorber. An illustrated table clearly indicates the procedure for each type of block. Suitable for use with any staking tool having a fitting of diameter Ø4.00mm. Horotec 13.153

Contents:

- 7 Stakes Ext Ø x Hole Ø: 1.65 x 1.20, 2.00 x 1.60, 2.30 x 1.90, 2.50 x 2.00, 3.00 x 2.50, 3.50 x 3.00, 4.00 x 3.50mm
- 6 Punches sizes Ext Ø x Hole Ø: 1.57 x 1.20, 1.87 x 1.40, 2.07 x 1.60, 2.47 x 1.90, 2.97 x 2.40, 3.47 x 2.80mm

Code	Description	UOM	Price
I19223	Incabloc Punch & Stake Set	EACH	£84.95



BROWSE & BUY



BROWSE & BUY



ORDER tracking

Kif Jewelling Tools

Kif Shockspring Tool

KIF



Set of 3 special vertical keys for turning Kif Trior shock springs to accurately remove or refit without loss or damage.

- Tool with or without shocksprings
- Tool with shocksprings contains 5 x KIF 1-2, 5 x KIF 1-3 & 5 x KIF 1-4 springs
- Small, medium and large (Ø1.60, Ø1.90 & Ø2.10mm)
- Sizes given correspond to Kif diameter
- Swiss
- Pack*3

Code	Description	UOM	Price
K0888	Kif Shockspring Tool	PACK*3	£23.95
K48080	Kif Shockspring Tool with Kif Shocksprings	PACK*3	£29.95
K39893	Ø1.60 Kif Shockspring Tool	EACH	£9.95
K39894	Ø1.90 Kif Shockspring Tool	EACH	£9.95
K39895	Ø2.10 Kif Shockspring Tool	EACH	£9.95

Novodiac Jewelling Tools

Novodiac Shockspring Tools



Novodiac Swiss Made

For removing and fitting the springs in Novodiac shock devices.

Code	Description	UOM	Price
N48217	ETA 2801, 2824.2, 2834.2, 2836.2 Novodiac Tool, A*F Swiss	EACH	£38.95
N48236	ETA 2801, 2824.2, 2834.2, 2836.2 Novodiac Tool, Horotec Swiss	EACH	£18.95
N48218	ETA 2671, 2660, 2671, 2688 Novodiac Tool, A*F Swiss	EACH	£38.95
N48237	ETA 2671, 2660, 2671, 2688 Novodiac Tool, Horotec Swiss	EACH	£16.50



TRADE SUPPLIER

Seitz Jewelling Tools

Seitz Jewelling Complete Outfit



- Seitz Jewelling Outfit
- Bergeon 30300
- Complete Set

- 1 Jewelling tool
 - 12 Flat (simple) pushers
 - 4 Stakes
 - 12 Pump pushers
 - 11 Concave pushers
 - 15 Reamers with spindle
 - 4 Tools for reducing holes in plates
 - 4 Tools for reducing hour hand holes
 - 3 Tools for setting levers
 - 1 Platform stake
 - 1 Micrometer needle with stake
 - 1 Bush for nut
 - 1 Pusher and stake for lanterning cannon pinions
 - 1 Bakelite base
- In wooden case

Code	Description	UOM	Price
J0885	Seitz Jewelling Complet Outfit	EACH	£875.00

Seitz Jewelling Tool with Spindle

- Bergeon30300.P
- See PDF for Full Operating Instructions



Code	Description	UOM	Price
J31073	Jewelling Tool with Spindle, Bergeon 30300P	EACH	£289.95
J31075	Spring For Spindle, Bergeon 31002.1	EACH	£1.25

Seitz Jewelling Concave Pushers

- Seitz - Bergeon 30521.1 & Size
- Replacement Concave Pushers
- Seitz 30300 Jewelling Outfit (J0885)

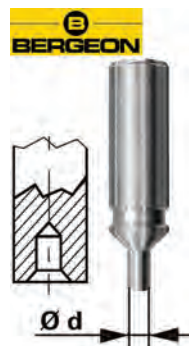

For driving in endstones

Code	Description	UOM	Price
J31078	Concave Pusher Set, Seitz	PACK*11	£49.95
J31056	Ø0.65mm Concave Pusher	EACH	£4.50
J31057	Ø0.75mm Concave Pusher	EACH	£4.50
J31058	Ø0.85mm Concave Pusher	EACH	£4.50
J30938	Ø0.95mm Concave Pusher	EACH	£4.50
J31061	Ø1.05mm Concave Pusher	EACH	£4.50

J30939	Ø1.15mm Concave Pusher	EACH	£4.50
J31059	Ø1.25mm Concave Pusher	EACH	£4.50
J31060	Ø1.35mm Concave Pusher	EACH	£4.50
J19448	Ø1.45mm Concave Pusher	EACH	£4.50
J31062	Ø1.55mm Concave Pusher	EACH	£4.50
J31063	Ø1.75mm Concave Pusher	EACH	£4.50

Seitz Jewelling Pump Pushers

- Seitz - Bergeon 30523-1 & Size
- Replacement Pump Pusher
- Seitz 30300 Jewelling Outfit (J0885)

For driving, for lowering balance jewels, flat jewels.



Code	Description	UOM	Price
J31079	Pump Pushers Set, Seitz	PACK*12	£220.00
J31064	Ø0.65mm Pump Pusher	EACH	£19.50
J31065	Ø0.75mm Pump Pusher	EACH	£19.50
J31066	Ø0.85mm Pump Pusher	EACH	£19.50
J30940	Ø0.95mm Pump Pusher	EACH	£19.50
J30941	Ø1.05mm Pump Pusher	EACH	£19.50
J30942	Ø1.15mm Pump Pusher	EACH	£19.50
J31067	Ø1.25mm Pump Pusher	EACH	£19.50
J31068	Ø1.45mm Pump Pusher	EACH	£19.50
J31069	Ø1.75mm Pump Pusher	EACH	£19.50
J31070	Ø1.95mm Pump Pusher	EACH	£19.50
J31071	Ø2.55mm Pump Pusher	EACH	£19.50
J31072	Ø2.95mm Pump Pusher	EACH	£19.50

Seitz Jewelling Flat Pushers, (Simple)

- Seitz - Bergeon 30520.A1 & Size
- Replacement Simple (Flat) Pusher
- Seitz 30300 Jewelling Outfit (J0885)

For driving, lowering flat jewels or endstones flush with the plate.



Code	Description	UOM	Price
J31077	Flat Pushers Set, Seitz	PACK*12	£96.95
J7531	Ø0.65mm Flat Pusher	EACH	£10.70
J30937	Ø0.75mm Flat Pusher	EACH	£10.70
J31051	Ø0.85mm Flat Pusher	EACH	£10.70
J18338	Ø0.95mm Flat Pusher	EACH	£10.70
J18339	Ø1.05mm Flat Pusher	EACH	£10.70
J31052	Ø1.15mm Flat Pusher	EACH	£10.70
J18340	Ø1.25mm Flat Pusher	EACH	£10.70
J18341	Ø1.45mm Flat Pusher	EACH	£10.70
J31053	Ø1.75mm Flat Pusher	EACH	£10.70
J31054	Ø1.95mm Flat Pusher	EACH	£10.70
J31055	Ø2.55mm Flat Pusher	EACH	£10.70
J18342	Ø2.95mm Flat Pusher	EACH	£10.70

Seitz Jewelling Micrometer Needle and Stake

- Seitz - Bergeon 30520.D
- Seitz Jewelling Outfit (J0885)

The jewellery tool can be used as a micrometer gauge. The hardened stake 30520.D2 (J31085) is fitted to the platform and the micrometer needle 30520.D1 (J31084) to the spindle.



Code	Description	UOM	Price
J31085	Micrometer Needle & Stake Set	PACK*2	£15.95
J31084	Micrometer Needle	EACH	£6.50
J30575	Stake Ø12mm for Micrometer Needle	EACH	£5.95
J30589	Stake Ø28mm, Bergeon 30520.C	EACH	£38.50

Seitz Jewelling Pushers and Stake for Lanterning Cannon Pinions

- Seitz - Bergeon 31001
- for use with Bergeon jewellery kit
- Cannon pinion tightening tool
- Items available as a set under item code: C4270

Fit the special punch to the spindle and the special stake to the platform of the jewellery tool. The blades must be exactly opposite each other and the micrometer screw must be set before the work is started.



Code	Description	UOM	Price
J30587	Pusher, Bergeon 31001.1	EACH	£12.50
J30588	Stake, Bergeon 31001-2	EACH	£6.50

Seitz Jewelling Pushers and Stake for Levers

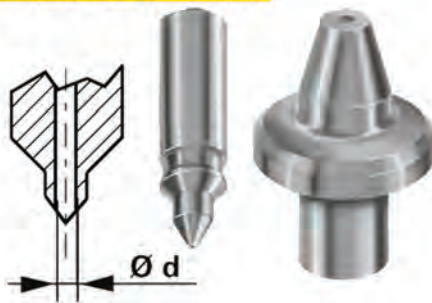

- Seitz - Bergeon 30525
- Replacement Pushers & Stakes
- Seitz 30300 Jewelling Outfit (J0885)

Lever's height on the pallet staff can be adjusted to within 0.005mm.

This is done by using the set of tools for setting levers.

Code	Description	UOM	Price
J31087	Lever Setting Set, Seitz	PACK*3	£39.95
J30584	Ø0.12mm Pusher for Setting Levers	EACH	£18.95
J30585	Ø0.18mm Pusher for Setting Levers	EACH	£18.95
J30586	Stake for Setting Levers	EACH	£9.95

Seitz Jewelling Reamers



- Seitz - Bergeon 30522A & Size
- Seitz - Bergeon 30522-B
- Reamer shank diameter Ø2.35mm
- Spindle for reamers
- Replacement reamers
- Seitz 30300 jewellery outfit (J0885)

For reaming holes for driving in larger jewels.

Code	Description	UOM	Price
J30573	Reamer Spindle	EACH	£25.95
J31076	Reamer Set, Seitz	PACK*15	£112.50
R7650A	Ø0.69mm Reamer	EACH	£6.85
R7650B	Ø0.79mm Reamer	EACH	£6.85
R19800	Ø0.89mm Reamer	EACH	£6.85
R7650C	Ø0.99mm Reamer	EACH	£6.85
R7650D	Ø1.09mm Reamer	EACH	£6.85
R7650E	Ø1.19mm Reamer	EACH	£6.85
R7650F	Ø1.29mm Reamer	EACH	£6.85
R7650G	Ø1.39mm Reamer	EACH	£6.85
R7650H	Ø1.49mm Reamer	EACH	£6.85
J31049	Ø1.59mm Reamer	EACH	£6.85
R7650I	Ø1.79mm Reamer	EACH	£6.85
R7650J	Ø1.99mm Reamer	EACH	£6.85
R7650K	Ø2.29mm Reamer	EACH	£6.85
R7650L	Ø2.59mm Reamer	EACH	£6.85
J31050	Ø2.99mm Reamer	EACH	£6.85

Seitz Jewelling Reducing Hour Hand Hole Tools

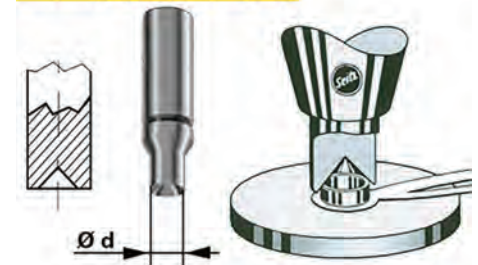

- Seitz - Bergeon 31000
- Set of 4 Tools
- Sizes: Ø1.25, 1.75, 2.25 & 2.75mm
- Seitz Jewelling Outfit (J0885)

Tools for reducing hour hand holes. These make it possible to reduce hand holes very accurately, to within 0.005mm. It is essential to use the micrometer screw for this work.

Code	Description	UOM	Price
J31086	Reducing Hour Hand Hole Tools Set	PACK*4	£21.95
J30580	Ø1.25mm Hour Hand Hole Reducing Tool	EACH	£7.50
J30581	Ø1.75mm Hour Hand Hole Reducing Tool	EACH	£7.50
J30582	Ø2.25mm Hour Hand Hole Reducing Tool	EACH	£7.50
J30583	Ø2.75mm Hour Hand Hole Reducing Tool	EACH	£7.50



Seitz Jewelling Reducing Jewel Hole Tools

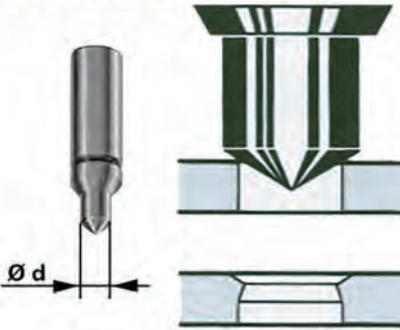

- Seitz - Bergeon 30524
- Set of 4 Tools
- Sizes: Ø1.00, 1.50, 2.00 & 2.50mm
- Seitz Jewelling Outfit (J0885)

Tools for reducing holes, these tools are useful when one wishes to avoid replacing a jewel that is still in good condition, but not held tightly enough in its hole.

Code	Description	UOM	Price
J31088	Reducing Hole Tools Set	PACK*4	£17.95
J30576	Ø1.00mm Reducing Jewel Hole Tool	EACH	£5.95
J30577	Ø1.50mm Reducing Jewel Hole Tool	EACH	£5.95
J30578	Ø2.00mm Reducing Jewel Hole Tool	EACH	£5.95
J30579	Ø2.50mm Reducing Jewel Hole Tool	EACH	£5.95

Seitz Jewelling Stakes

- Seitz - Bergeon 30520-B
- Stakes for the platform
- Drill with hole & without hole
- Seitz Jewelling Outfit (J0885)



Code	Description	UOM	Price
J30574	Stakes Set, Seitz	PACK*4	£17.95
J31080	Ø1.50mm Stake, Non Perforated	EACH	£4.95
J31081	Ø2.00mm Stake, Perforated	EACH	£4.95
J31082	Ø4.00mm Stake, Perforated	EACH	£4.95
J31083	Ø5.00mm Stake, Perforated	EACH	£4.95

MAINSRING WINDERS

Watch, Bergeon 2795-ETA



Bergeon 2795ETA

Assortment of 12 mainspring winders for ETA calibres contents includes one handle in wooden case with the following winders.

Set includes:

- 2729ETA01 suitable for calibre 1727
- 2729ETA02 suitable for calibres 2000.1/2004.1/2094
- 2729ETA03 suitable for calibres 2660/2671/2678/2688
- 2729ETA04 suitable for calibres 2801.2/2804.2
- 2729ETA05 suitable for calibres 2824.2/2834.2/2836.2
- 2729ETA06 suitable for calibre 2846.2
- 2729ETA07 suitable for calibres 2892A2/2893.1 .2 .3/2894.2/2895.2/2896/2897
- 2729ETA08 suitable for calibre 7001
- 2729ETA09 suitable for calibres 7750/7751/7753/7754
- 2729ETA10 suitable for calibres 7760/7765
- 2729ETA11 suitable for calibres 6497.1/6498.1
- 2729ETA12 suitable for calibres 6497.2/6498.2

Replacement winder handles, see our codes M43272 & M43273

Replacement winders available, see our code M44115

Code	Description	UOM	Price
M20152	Assortment of 12 Mainspring Winders for ETA Calibres	EACH	£695.00

Watch, Bergeon 5355



Assortment of 7 right hand mainspring winders & 7 left hand arbors for mainsprings

- Ø5.60mm to Ø9.80mm right hand mainspring winders and handle
- Ø5.60mm to Ø9.80mm left hand arbors and handle
- No.0 to 6 right & left hand
- In wooden case
- Pack*16
- Winders available separately, see code M40221
- Winder Handles available separately, see codes M43272 & M43273

Set Includes (right and left hand):

- No.0 = Ø5.60mm
- No.1 = Ø6.00mm
- No.2 = Ø6.50mm
- No.3 = Ø7.10mm
- No.4 = Ø7.80mm
- No.5 = Ø8.60mm
- No.6 = Ø9.80mm
- Right hand handle
- Left hand handle

Code	Description	UOM	Price
M38468	Mainspring Winder, Bergeon 5355	EACH	£443.95

Watch, Bergeon 5356



Mainspring Winder - Wrist & Pocket Watch

- Assortments of 17 winders & 17 arbors for Nivaflex mainsprings and other qualities of steel
- Winders available separately, see code M40221
- Winder Handles available separately, see codes M43272 & M43273

Contents:

- 17 mainspring winders for right hand No 00 - 15 and 1 handle
- 17 arbors for left hand No 00 - 15 and 1 handle
- Ø5.3mm to Ø19mm
- In wooden case
- Red point: on right
- Blue point: on left

Code	Description	UOM	Price
M0952	Bergeon 5356 Pocket and Wrist Watch Mainspring Winder	EACH	£950.00

Watch, Bergeon Arbors for Winders

Bergeon - Swiss Made - Right & Left Hand Arbors

- Replacement arbors for Bergeon mainspring winders
- Can turn a right hand winder into a left hand winder
- Can be used with any Bergeon mainspring winders, including our sets M38468 & M0952
- To be used with mainspring winders, see code M40221 for range
- If size is not currently listed, please ask via our online support system
- Bergeon 2729.MNG.XX & 2729.MND.XX



Code	Description	UOM	Price
M55826	Left Hand, Ø7.80mm (No.4) Arbor	EACH	£24.50
M49225	Left Hand, Ø8.60mm (No.5) Arbor	EACH	£24.50
M50361	Left Hand, Ø9.80mm (No.6) Arbor	EACH	£24.50
M48702	Left Hand, Ø10.80mm (No.7) Arbor	EACH	£24.50
M48703	Left Hand, Ø12.00mm (No.8) Arbor	EACH	£24.50
M48704	Left Hand, Ø13.00mm (No.9) Arbor	EACH	£24.50



MOVEMENT HOLDERS

Ø7mm to 50mm, Plastic Rings

- Movement Holders
- Plastic Rings
- Set of 12
- Diameter: Ø7mm to Ø50mm



Code	Description	UOM	Price
M0984	Ø7mm to Ø50mm Plastic Ring Holders	PACK*12	£2.25

Adjustable

Adjustable Movement Holders

- Ladies or gents
- Adjustable
- Aluminium
- Knurled handles
- Made in India



Code	Description	UOM	Price
M38222	Ø9mm to Ø23mm Movement Holder	EACH	£2.45
M38221	Ø9mm to Ø65mm Movement Holder	EACH	£3.95

3 ¾ to 11 Ligne, A*F Swiss

- A*F Swiss
- Swiss Made
- Adjustable 3 ¾ to 11 ligne
- Steel Frame



Code	Description	UOM	Price
M0972	3 ¾ to 11 Ligne, A*F Swiss	EACH	£25.50

3 ¾ to 11 Ligne, Bergeon 4039P - Carbon Fibre

- Bergeon 4039P
- Swiss Made
- Adjustable 3 ¾ to 11 ligne
- Carbon Fibre Frame



Code	Description	UOM	Price
M32570	3 ¾ to 11 Ligne, Bergeon 4039P - Carbon Fibre	EACH	£14.75

3 ¾ to 11 Ligne, Bergeon 4039

- Bergeon 4039
- Swiss Made
- Adjustable 3 ¾ to 11 ligne
- Steel Frame



Code	Description	UOM	Price
M0974	3 ¾ to 11 Ligne, Bergeon 4039	EACH	£15.85

Watch, Bergeon Winders by Size

- Bergeon watch mainspring winders by size
- Barrel drum and arbor
- Replacements for all Bergeon sets
- For use with Bergeon winder handles, our code M43272 & M43273
- Replacements for our sets M38468 & M0952
- Right or left hand available
- If size is not currently listed, please ask via our online support system
- Bergeon 2729



- Dimensions:
- Right/Left Handed, Size (Bergeon number)
 - Size equals barrel drum size (outer diameter)

Code	Description	UOM	Price
M47696	Left Hand, Ø6.00mm (No.1) Winder	EACH	£41.95
M47697	Left Hand, Ø6.50mm (No.2) Winder	EACH	£41.95
M45736	Left Hand, Ø7.80mm (No.4) Winder	EACH	£41.95
M48985	Left Hand, Ø9.80mm (No.6) Winder	EACH	£41.95
M44277	Left Hand, Ø10.80mm (No.7) Winder	EACH	£41.95
M48986	Left Hand, Ø12.00mm (No.8) Winder	EACH	£41.95
M51701	Left Hand, Ø13.00mm (No.9) Winder	EACH	£41.95
M52449	Left Hand, Ø14.00mm (No.10) Winder	EACH	£41.95
M49312	Left Hand, Ø17mm (No.13) Winder	EACH	£41.95
M48343	Left Hand, Ø18.00mm (No.14) Winder	EACH	£41.95
M40221	Right Hand, Ø6.00mm (No.1) Winder	EACH	£41.95
M40222	Right Hand, Ø7.80mm (No.4) Winder	EACH	£41.95
M51473	Right Hand, Ø8.60mm (No.5) Winder	EACH	£41.95
M45756	Right Hand, Ø9.80mm (No.6) Winder	EACH	£41.95
M37765	Right Hand, Ø10.80mm (No.7) Winder	EACH	£41.95
M37766	Right Hand, Ø12.00mm (No.8) Winder	EACH	£41.95
M51048	Right Hand, Ø14.00mm (No.10) Winder	EACH	£41.95
M52010	Right Hand, Ø15.00mm (No.11) Winder	EACH	£41.95
M48357	Right Hand, Ø18.00mm (No.14) Winder	EACH	£41.95

M48705	Left Hand, Ø14.00mm (No.10) Arbor	EACH	£24.50
M48706	Left Hand, Ø15.00mm (No.11) Arbor	EACH	£24.50
M48707	Left Hand, Ø16.00mm (No.12) Arbor	EACH	£24.50
M48708	Left Hand, Ø17.00mm (No.13) Arbor	EACH	£24.50
M48709	Left Hand, Ø18.00mm (No.14) Arbor	EACH	£24.50
M48710	Left Hand, Ø19.00mm (No.15) Arbor	EACH	£24.50
M54002	Right Hand, Ø6.00mm (No.2) Arbor	EACH	£24.50
M54003	Right Hand, Ø7.80mm (No.4) Arbor	EACH	£24.50
M55114	Right Hand, Ø8.60mm (No.5) Arbor	EACH	£24.50
M55115	Right Hand, Ø9.80mm (No.6) Arbor	EACH	£24.50
M55609	Right Hand, Ø10.80mm (No.7) Arbor	EACH	£24.50

Watch, Bergeon Handle for Winders



- Cylindrical handles for watch mainspring winders
- Plunger releases the mainspring straight from the winder into the barrel
- Right & left hand
- Can be used with any Bergeon mainspring winders, including our sets M20152, M38468 & M0952
- To be used with mainspring winder arbors, see code M40221 for range
- Bergeon 30082-M & 30082-MG
- Swiss

Code	Description	UOM	Price
M43273	Left Hand Mainspring Winder Handle	EACH	£33.95
M43272	Right Hand Mainspring Winder Handle	EACH	£33.95

Watch, Bergeon Winders by Calibre

- Bergeon watch mainspring winders by calibre
- Barrel drum and arbor
- Replacements for all Bergeon sets
- For use with Bergeon winder handles, our code M43272 & M43273
- Replacements for our set M20152



Code	Description	UOM	Price
M44115	AS 1727	EACH	£47.50
M44116	ETA 2000.1, 2004.1, 2094	EACH	£47.50
M44117	ETA 2660, 2671, 2678, 2688	EACH	£47.50
M44118	ETA 2801.2, 2804.2	EACH	£47.50
M42400	ETA 2824.2, 2834.2, 2836.2	EACH	£44.75
M44119	ETA 2846.2	EACH	£47.50
M44120	ETA 2892A2, 2893.1 .2 .3, 2894.2, 2895.2, 2896, 2897	EACH	£47.50
M44121	ETA 7001	EACH	£47.50
M44123	ETA 6497.1, 6498.1	EACH	£47.50
M44124	ETA 6497.2, 6498.2	EACH	£47.50
M41896	Valjoux 7750, 7751, 7753, 7754 Winder	EACH	£44.75
M44122	Valjoux 7760, 7765	EACH	£47.50

Watch, Rolex Calibres



Watch Mainspring Winders Specific to Rolex Calibres

- Watch mainspring winders specific to Rolex calibres
- Calibres 1530, 1575, 2130, 2135, 3035 & 3135
- High quality
- Winders also available individually
- Supplied in plastic box
- Made in South Korea

Code	Description	UOM	Price
M53338	Rolex Mainspring Winder Set	PACK*3	£375.00
M53340	Rolex 1530/1575 Mainspring Winder	EACH	£139.95
M53339	Rolex 2130/2135 Mainspring Winder	EACH	£139.95
M53341	Rolex 3035/3135 Mainspring Winder	EACH	£139.95

8 ¾ to 19 Ligne, Bergeon 4040P - Carbon Fibre

- Bergeon 4040P
- Swiss Made
- Adjustable 8 ¾ to 19 Ligne.
- Carbon Fibre Frame



Code	Description	UOM	Price
M32569	8 ¾ to 19 Ligne, Bergeon 4040P - Carbon Fibre	EACH	£15.75

8 ¾ to 19 Ligne, Bergeon 4040

- Bergeon 4040
- Swiss Made
- Adjustable 8 ¾ to 19 Ligne.
- Steel Frame



Code	Description	UOM	Price
M0975	8 ¾ to 19 Ligne, Bergeon 4040	EACH	£15.90

Ø25mm to Ø62mm, Bergeon 30211 - Pocketwatch

- Bergeon 30211
- Swiss Made
- Pocket Watch
- Steel Frame



Code	Description	UOM	Price
M32676	Ø25mm to Ø62mm, Bergeon 30211 - Pocketwatch	EACH	£52.90

By Size, Bergeon 1996



Bergeon 1996 (+ Ligne size) - Swiss Made

- Individual movement holders specific to one ligne size only
- With adjustable hollow centre screw for hand setting support
- Base Ø31mm
- Swiss Made

Code	Description	UOM	Price
M43030	4 ¼ Ligne Movement Holder	EACH	£35.50
M43031	5 Ligne Movement Holder	EACH	£35.50
M43032	5 ½ Ligne Movement Holder	EACH	£35.50
M43033	5 ½ Ligne Movement Holder	EACH	£35.50
M43034	5 ¾ Ligne Movement Holder	EACH	£35.50
M43035	6 Ligne Movement Holder	EACH	£35.50
M43036	6 ½ Ligne Movement Holder	EACH	£35.50
M43037	6 ¾ Ligne Movement Holder	EACH	£35.50
M43038	7 ¼ Ligne Movement Holder	EACH	£35.50
M43039	7 ½ Ligne Movement Holder	EACH	£35.50
M0976	7 ¾ Ligne Movement Holder	EACH	£35.50
M43040	8 Ligne Movement Holder	EACH	£35.50

M2995	8 ¼ Ligne Movement Holder	EACH	£35.50
M0977	8 ¾ Ligne Movement Holder	EACH	£35.50
M43041	9 Ligne Movement Holder	EACH	£35.50
M43042	9 ¼ Ligne Movement Holder	EACH	£35.50
M43043	9 ½ Ligne Movement Holder	EACH	£35.50
M0978	9 ¾ Ligne Movement Holder	EACH	£35.50
M0979	10 ½ Ligne Movement Holder	EACH	£35.50
M43044	10 ¾ Ligne Movement Holder	EACH	£35.50
M43045	11 Ligne Movement Holder	EACH	£35.50
M43046	11 ¼ Ligne Movement Holder	EACH	£35.50
M0980	11 ½ Ligne Movement Holder	EACH	£35.50
M35295	11 ¾ Ligne Movement Holder	EACH	£35.50
M36112	12 Ligne Movement Holder	EACH	£35.50
M43047	12 ¼ Ligne Movement Holder	EACH	£35.50
M0981	12 ½ Ligne Movement Holder	EACH	£35.50
M43048	12 ¾ Ligne Movement Holder	EACH	£35.50
M43049	13 Ligne Movement Holder	EACH	£35.50
M43050	13 ¼ Ligne Movement Holder	EACH	£35.50
M43051	13 ½ Ligne Movement Holder	EACH	£35.50
M43052	13 ¾ Ligne Movement Holder	EACH	£35.50
M43053	14 Ligne Movement Holder	EACH	£35.95
M43054	14 ½ Ligne Movement Holder	EACH	£35.95
M43055	15 Ligne Movement Holder	EACH	£35.95
M43056	16 Ligne Movement Holder	EACH	£35.95
M43057	17 Ligne Movement Holder	EACH	£35.95
M43058	17 Ligne Movement Holder	EACH	£35.95
M43059	19 Ligne Movement Holder	EACH	£35.95

By Size, Bergeon 5914



Bergeon 5914 (+ ligne size) - Swiss Made

- Individual movement holders specific to one ligne size only
- Round shape
- Reversible
- In nickelled brass
- Swiss Made

Code	Description	UOM	Price
M43079	4 ¼ Ligne Movement Holder	EACH	£23.90
M43080	5 Ligne Movement Holder	EACH	£23.90
M43081	5 ¼ Ligne Movement Holder	EACH	£23.90
M43082	5 ½ Ligne Movement Holder	EACH	£23.90
M43083	5 ¾ Ligne Movement Holder	EACH	£23.90
M43084	6 Ligne Movement Holder	EACH	£23.90
M43085	6 ½ Ligne Movement Holder	EACH	£23.90
M43086	6 ¾ Ligne Movement Holder	EACH	£23.90
M43087	7 Ligne Movement Holder	EACH	£23.90
M43088	7 ½ Ligne Movement Holder	EACH	£23.90
M43089	7 ¾ Ligne Movement Holder	EACH	£23.90
M43090	8 Ligne Movement Holder	EACH	£23.90
M43091	8 ¼ Ligne Movement Holder	EACH	£23.90
M43092	8 ¾ Ligne Movement Holder	EACH	£23.90
M43093	9 Ligne Movement Holder	EACH	£23.90
M43094	9 ¼ Ligne Movement Holder	EACH	£23.90
M43095	9 ½ Ligne Movement Holder	EACH	£23.90
M43096	9 ¾ Ligne Movement Holder	EACH	£23.90
M43097	10 ½ Ligne Movement Holder	EACH	£23.90
M43098	10 ¾ Ligne Movement Holder	EACH	£23.90
M43099	11 Ligne Movement Holder	EACH	£23.90
M43100	11 ¼ Ligne Movement Holder	EACH	£23.90
M43101	11 ½ Ligne Movement Holder	EACH	£23.90
M43102	11 ¾ Ligne Movement Holder	EACH	£23.90
M43103	12 Ligne Movement Holder	EACH	£23.90
M43104	12 ¼ Ligne Movement Holder	EACH	£23.90
M43105	12 ½ Ligne Movement Holder	EACH	£23.90

M43106	12 ¾ Ligne Movement Holder	EACH	£23.90
M43107	13 Ligne Movement Holder	EACH	£23.90
M43108	13 ¼ Ligne Movement Holder	EACH	£23.90
M43109	13 ½ Ligne Movement Holder	EACH	£23.90
M43110	13 ¾ Ligne Movement Holder	EACH	£23.90
M43111	14 Ligne Movement Holder	EACH	£23.90
M43112	14 ½ Ligne Movement Holder	EACH	£23.90
M43113	16 Ligne Movement Holder	EACH	£29.95
M43114	16 ½ Ligne Movement Holder	EACH	£29.95
M43115	17 Ligne Movement Holder	EACH	£30.95
M43116	18 Ligne Movement Holder	EACH	£30.95
M43117	18 ½ Ligne Movement Holder	EACH	£30.95
M43118	19 Ligne Movement Holder	EACH	£30.95
M43119	19 ½ Ligne Movement Holder	EACH	£31.85
M43120	22 Ligne Movement Holder	EACH	£31.85

By Size, Bergeon 7100 (For Hand Setting)



Bergeon 7100 (+ Ligne size) - Swiss Made

- Individual movement holders specific to one ligne size only
- Tempered steel bearing screw with polished tip & locking system for hand setting
- Anodised aluminium
- Base Ø31mm
- Swiss Made

Code	Description	UOM	Price
M49639	6 ¾ Ligne Movement	EACH	£49.95
M49646	6 ¾ x 8 Ligne Movement	EACH	£62.45
M49640	7 ¾ Ligne Movement	EACH	£49.95
M49641	8 ¼ Ligne Movement	EACH	£49.95
M49642	8 ¾ Ligne Movement	EACH	£49.95
M49643	10 ½ Ligne Movement	EACH	£49.95
M49644	11 ½ Ligne Movement	EACH	£49.95
M49645	13 ¼ Ligne Movement	EACH	£49.95

By Size, Economy



- Individual movement holders
- Ladies or gents
- Plastic
- Incredible value
- Inexpensive to replace of lost or damaged
- Colour may vary
- Made in India

Code	Description	UOM	Price
M39630	6 ¾ to 8 Ligne Movement Holder	EACH	£1.50
M39631	10 ½ Ligne Movement Holder	EACH	£1.50

Spring Loaded, Swiss Style

VALUE



Movement Holders - Swiss Style

- Spring loaded
- Metal construction
- Ladies or gents

Code	Description	UOM	Price
M39628	Up to Ø15mm (Ladies)	EACH	£4.95
M39629	Up to Ø20mm (Gents)	EACH	£4.95

Universal, Sprung Loaded

VALUE



- Spring loaded universal style
- Nicked steel tubes with black steel ends
- White nylon pins
- Maximum capacity Ø36mm diameter

Code	Description	UOM	Price
M7612	36mm Capacity Sprung Loaded Watch Movement Holder	EACH	£3.85

Swivel Base, Horotec Swiss

HOROTEC SWISS



Horotec 14.447 - Swivel Movement Holder

- Ø75mm platform
- Ø95mm base
- Platform is mounted on 360 ° ball joint & capable of leaning at 45 °, giving maximum flexibility whilst working
- Platform has anti skid coating
- Aluminium base
- Platform is removable
- Perfect for your bench or for viewing parts under a microscope
- Overall height 40mm
- Horotec Swiss

Code	Description	UOM	Price
M49775	Ø75mm Movement Swivel Platform	EACH	£194.95

for ETA 251.2XX Series



A*F - Swiss Made
Bergeon - Swiss made

Metal or plastic movement holder for hand setting and chronograph function checking.

- 13 ¼ Ligne
- 4 pushers @ 2h, 4h, 8h & 10h
- See web "more Info" for full specification

Specifically for ETA calibres:

- 251.252
- 251.262
- 251.265
- 251.272

Code	Description	UOM	Price
251252MA	A*F Swiss ETA 251.2XX Series Movement Holder	EACH	£32.95
M44216	Bergeon Swiss ETA 251.2XX Series Movement Holder	EACH	£189.95

for ETA 251.471

A*F 185.137 - Swiss Made



Plastic movement holder for hand setting and chronograph function checking. For calibre ETA 251.471.

- 10 ½ Ligne
- Movement holder with 2 push pieces
- Specifically for calibre ETA 251.471

Code	Description	UOM	Price
251471MA	ETA 251.471 Watch Movement Holder	EACH	£36.08

for ETA 2824

Horotec 09.050.02



Plastic movement holder for movement repair hand setting function checking. For calibre ETA 2824.

- 11 ½ Ligne
- Green Plastic

Code	Description	UOM	Price
M48226	ETA 2824, Horotec 09.050.02	EACH	£3.00

for ETA 2892.A2

Begeon 1999 - Swiss Made



Metal movement holder for hand setting and chronograph function checking. For calibre ETA 2892.A2

- 11 ½ to 13 ¼ Ligne
- 4 pushers @ 4h, 8h, 10h & 11h
- 4 support screws in tempered steel

Code	Description	UOM	Price
M44276	ETA 2892.A2 Movement Holder	EACH	£164.50

for ETA 2892.2 & Omega 1140

A*F 185.140.1140 - Swiss Made



Plastic movement holder for hand setting and chronograph function checking. For calibres ETA 2892.2 & Omega 1140.

- Omega 1140
- ETA 2892.2
- 11 ¼ Ligne
- 2 Pushers

Code	Description	UOM	Price
M12157	Omega 1140 & ETA 2892-2 Movement Holder	EACH	£23.95

for ETA 2894 & 2894.2



Horotec 09.010-30 - Swiss Made
Horotec 09.010-40 - Swiss Made

Metal round watch movement holder with 2 pushers and supports specific for calibres ETA 2894 & 2894.2

- 12 ½ Ligne
- 2 pushers
- 4 support screws in tempered steel (2894.2)

Code	Description	UOM	Price
M48223	ETA 2894, Horotec 09.010.30	EACH	£159.95
M48224	ETA 2894.2, Horotec 09.010.40	EACH	£174.95

for Frederic Piguet 1185

HORIA
MECANIQUE DE PRECISION



Horia - Swiss Made

Metal movement holder for hand setting and chronograph function checking. For calibre Frederic Piguet 1185.

- 4 adjustable screws
- 1 tightening screw
- 6 pushers
- 4 supports

Code	Description	UOM	Price
M50553	Frederic Piguet 1185 Movement Holder	EACH	£350.00

PRICE PROMISE
GUARANTEE



Online Discounts

for Ronda 4XXX, 5XXX Series



Horotec 09.010-47 - Swiss Made

Metal round watch movement holder with 2 pushers and supports specific for the Ronda calibres detailed below

- 2 pushers
- 4 support screws in tempered steel

For Ronda calibres:

- 4002.B, 4003.B, 4120.B, 4210.B, 4220.B, 5010.B, 5020.B, 5022.D, 5030.D, 5040.B, 5040.D, 5040.E, 5050.B, 5050.C, 5051.C, 5130.B & 5130.B

Code	Description	UOM	Price
M49600	Ronda 4XXX & 5XXX Movement Holder	EACH	£205.00

for Omega 861

A*F 185.140.861 - Swiss Made

Plastic movement holder for hand setting and chronograph function checking. For calibre Omega 861.

- Omega 861
- 12 Ligne
- 2 Pushers
- 2 supports

Code	Description	UOM	Price
M12158	Omega 861 Movement Holder	EACH	£26.95

for Unitas 6497 / 6498

Horotec 09.010-38 - Swiss Made

Metal round pocket watch movement holder with 2 supports for ETA calibre Unitas 6497 & 6498

- 16 1/2 Ligne
- 2 support screws in tempered steel

Code	Description	UOM	Price
M48222	Unitas 6497/6498. Horotec 09.010.38	EACH	£113.95

for Valjoux 7750 & 7753, A*F Swiss, Metal

A*F 185.141.7750-53 - Swiss Made

Metal movement holder for calibre Valjoux 7750 & 7753

- 13 1/4 Ligne

- Pushers @ 2h & 4h (for both calibres)

Code	Description	UOM	Price
M40274	for Valjoux 7750 & 7753, A*F Swiss, Metal	EACH	£94.95

Cousins Swiss Style, Valjoux 7750, Metal

Cousins Swiss Style

Metal movement holder calibre Valjoux 7750.

- 13 1/4 Ligne
- Pushers access @ 2h, 4 & 10h

Code	Description	UOM	Price
M53094	Cousins Swiss Style, Valjoux 7750, Metal	EACH	£45.95

for Valjoux 7750, Horotec Swiss

Horotec 09.050.01

Plastic movement holder for calibre Valjoux 7750.

- 13 1/4 Ligne
- Pusher access & 2 & 4h

Code	Description	UOM	Price
M48227	for Valjoux 7750, Horotec Swiss	EACH	£6.75

for Valjoux 7750 Series with Hand Fiting Supports, A&F



A*F Swiss Made

- Metal or plastic movement holders for hand setting and chronograph function checking
- For calibres Valjoux 7750 & 7753

Code	Description	UOM	Price
7750MB	for Valjoux 7750, A*F Swiss, Plastic	EACH	£25.95
M40275	for Valjoux 7750, A*F Swiss, Metal	EACH	£88.95
M40276	for Valjoux 7750, A*F Swiss, Metal, Tip Support	PACK*4	£2.95
M40277	for Valjoux 7750, A*F Swiss, Metal, Space Screw	PACK*4	£2.95

for Valjoux 7750 Series with Hand Fiting Supports, Bergeon

Bergeon 1998 - Swiss Made

- Metal movement holder for hand setting and chronograph function checking
- For calibre Valjoux 7750.
- 13 1/4 Ligne
- Pushers @ 2h & 4h
- Supports at centre and 12 o'clock

Code	Description	UOM	Price
M44215	for Valjoux 7750, Bergeon, Metal,	EACH	£194.95
M53158	Bergeon, Valjoux 7750, Metal, Tip Support & Screw	EACH	£16.75

for Valjoux 7750 Series & Sellita SW500 with Hand Fiting Supports, Bergeon 7100

Bergeon 7100 - Swiss Made



- Metal movement holder for hand setting and chronograph function checking
- For calibre Valjoux 7750 & Sellita SW500
- 13 1/4 Ligne
- Pushers @ 2h, 4h, 8 & 10h
- Supports at centre and 12 o'clock

Code	Description	UOM	Price
M55946	Bergeon, Valjoux 7750 & Sellita SW500 Movement Holder	EACH	£125.00

for Valjoux 7750 Series with Hand Fiting Supports, Cousins

Cousins Swiss Style

- Metal movement holder for hand setting and chronograph function checking
- For calibre Valjoux 7750.
- 13 1/4 Ligne
- Pushers @ 2h, 4h, 8h & 10h
- Supports at centre and 12 o'clock

Code	Description	UOM	Price
M53246	Cousins Swiss Style, Valjoux 7750, Metal	EACH	£49.95

for Valjoux 7750 Series with Hand Fiting Supports, ETA

From ETA Switzerland - Swiss Made

- Metal movement holder specifically for various Valjoux
- Calibres with up to 3 push-pieces
- Specifically for calibres: 7750, 7751, 7753, 7754, 7757, 7758, 7760, 7765, 7768 & 7770

Code	Description	UOM	Price
7750MA	for Valjoux 7750 Series, ETA	EACH	£495.00

for Valjoux 7750 Series with Hand Fiting Supports, Horia

Horia - Swiss Made

- Super quality metal movement holder for hand setting and chronograph function checking
- For calibres Valjoux 7750 & 7753
- 13 1/4 Ligne
- 6 Pushers
- Multiple support screws

Code	Description	UOM	Price
M48225	for Valjoux 7750 to 7753, Horia	EACH	£295.00

TRADE SUPPLIER

Online Discounts

for Zenith 400 Series & Rolex 4030

Horia - Swiss Made

Metal movement holder for hand setting and chronograph function checking. For calibre Zenith 400, 410 & 420 & Rolex calibre 4030.

- 6 pushers
- 2 supports



Code	Description	UOM	Price
M40278	Zenith 400 Series Movement Holder	EACH	£350.00

for Zenith 3019

A*F 185.140.3019 - Swiss Made

Plastic movement holder for hand setting and chronograph function checking. For calibre Zenith 3019.

- 13 ¼ Ligne
- Pushers @ 2h & 4h
- 4 supports



Code	Description	UOM	Price
M13751	Zenith 3019 Movement Holder	EACH	£60.95

OILING TOOLS

When oiling a watch, it is essential to have a tool that provides accuracy as well as the ability to deliver the right quantity of lubricant. Too much oil can be just as bad as too little.

Here on this page you will notice our large range of oiling tools to apply oils to everyday watches as well as the most top quality brands.

- Bergeon oiling tools have been considered the very best for generations and have adapted their designs with smart thinking in mind.
- A*F Swiss range of oil tools are excellent in quality as a standard everyday use
- We have a selection of Indian made oil tools and for the price, are of a well-made quality ideal for the beginner, learner or student watchmaker

Oil Pots (Multiple Cups)**3 In 1 Oil Pot, Indian** **VALUE**

- 3 In 1 Oil Pot Opaque Hard Plastic
- Ø50mm overall
- Lidded
- Sinks: 15, 13 and 11mm



Code	Description	UOM	Price
O7982	3 In 1 Oil Pot, Indian	EACH	£1.50

3 Pot Oil Stand, Indian **VALUE**

- Excellent value steel construction
- Three different sized ruby red style plastic reservoirs
- Rubber padded bottom, non-slip and plastic flip covering lid
- With 3 oil nib cleaners



Size: 60 x 45 x 30mm

Code	Description	UOM	Price
O36113	3 Pot Oil Stand, Indian	EACH	£9.95

4 Pot Oil Stand, Made in France

- 85 x 40 x 27mm overall.
- Non slip base
- Plastic reservoirs
- Roll top
- Made in France



Code	Description	UOM	Price
O1041	4 Pot Oil Stand, Made in France	EACH	£20.95

4 Pot Oil Stand, Bergeon Swiss - Die Cast

- Bergeon 30180A
- Oil cup stand in die cast alloy, sanded
- 90 x 50mm

- 4 red agate reservoirs
- Ø6mm
- Ø8mm
- Ø9mm
- Ø10mm

Code	Description	UOM	Price
O1035	4 Pot Oil Stand, Bergeon Swiss - Die Cast	EACH	£94.95

Moebius 8991, Fixodrop Epilame

See Page 1260

**4 Pot Oil Stand, Bergeon Swiss - Polished**

- Bergeon 30180
- Polished finish
- Oil cup stand in polished brass, chromium plated

- 4 red agate reservoirs
- Ø6mm
- Ø8mm
- Ø9mm
- Ø10mm

Code	Description	UOM	Price
O1036	4 Pot Oil Stand, Bergeon Swiss - Polished	EACH	£259.95

4 Pot Oil Stand, Swiss Style

- 4 oil pot stand, Swiss style
- 4 ceramic reservoirs (3 white & 1 red)
- Heavy metal oil cup stand & lids
- High quality
- With pith wood holder
- 90 x 50 x 20mm

Code	Description	UOM	Price
O39557	4 Pot Oil Stand, Swiss Style	EACH	£34.95

Oil Pots (Single Cups) A* F Swiss

- A*F Swiss Made
- Single with lid
- Synthetic material
- Colour coded

- Dimensions:
- Well diameter (colour)

**PRICE PROMISE
GUARANTEE**

• Ø45mm Overall

Code	Description	UOM	Price
O1037	Ø9mm (Red) Oil Cup, A*F Swiss	EACH	£24.75
O7616	Ø11mm (Blue) Oil Cup, A*F Swiss	EACH	£24.75
O7617	Ø20mm (Green) Oil Cup, A*F Swiss	EACH	£24.75
O7618	Ø27mm (Yellow) Oil Cup, A*F Swiss	EACH	£24.75

Oil Pots (Single Cups) Bergeon Swiss



Bergeon 6885 series - Swiss Made

- Single with lid
- Glass wells
- Synthetic material
- Colour coded
- Overall diameter Ø34mm

Dimensions:

- Well diameter (colour)

Code	Description	UOM	Price
O47441	Ø6mm (Red) Oil Cup	EACH	£14.85
O47442	Ø8mm (Blue) Oil Cup	EACH	£14.85
O47443	Ø10mm (Green) Oil Cup	EACH	£14.85
O47444	Ø12mm (Yellow) Oil Cup	EACH	£14.85
O47445	Ø12mm (Grey) Oil Cup	EACH	£14.85
O47446	Ø12mm (Black) Oil Cup	EACH	£14.85

Oil Pots (Single Cups) Value

VALUE



Value - Made in India

- Single with lid
- Synthetic material
- Colour coded

Dimensions:

- Well diameter (colour)
- Ø30mm Overall (cream = Ø45mm)

Code	Description	UOM	Price
O38659	Ø8mm (Black) Oil Cup	EACH	£1.45
O38660	Ø10mm (Blue) Oil Cup	EACH	£1.45
O7983	Ø11mm (Cream) Oil Cup	EACH	£1.30
O38661	Ø14mm (Green) Oil Cup	EACH	£1.45
O38662	Ø17mm (Red) Oil Cup	EACH	£1.45

Stem Oiler,
Bergeon Swiss

See Page 1158



Oilers (Automatic), Bergeon (New Style)



Automatic Oilers - Bergeon

An automatic oiler is the best tool for any application which requires a precise amount of oil to be carefully deposited.

- New Ergonomic style
- Easy use
- Oil is inside & protected against dust
- Supplied on base
- Capacity 100mm³
- Capacity for spare needle in the end (not supplied)
- Bergeon recommend cleaning the reservoirs in an ultrasonic tank

A39007 - Bergeon 7721

Complete set of all 3 automatic oilers, supplied on ergonomic stand

A38400 - Bergeon 7718.1A:

For shock protection devices in watches and balance bearings of all kinds.

A38401 - Bergeon 7719.2A:

For pallets, mechanical parts, oiling spots difficult to reach.

A38402 - Bergeon 7720.5:

For train wheel pivots, cup bearings, everywhere the oiler has to be positioned before depositing oil.

For Bergeon automatic oiler spare parts please see category below.

Automatic Oiler Set



- Bergeon 7721
- Includes auto oiler 1A, 2A & 5
- Supplied on ergonomic plastic stand

Code	Description	UOM	Price
A39007	Automatic Oiler Set	PACK*3	£179.95

Auto Oiler 1A - Bergeon 7718-1A

- Bergeon 7718.1A
- For shock protection devices in watches and balance bearings of all kinds
- Capacity 100mm³



Code	Description	UOM	Price
A38400	Auto Oiler 1A - Bergeon 7718-1A	EACH	£63.95

Auto Oiler 2A - Bergeon 7719-2A

- Bergeon 7719.2A
- For pallets, mechanical parts, oiling spots difficult to reach
- Capacity 100mm³



Code	Description	UOM	Price
A38401	Auto Oiler 2A - Bergeon 7719-2A	EACH	£63.95

Auto Oiler 5 - Bergeon 7720-5

- Bergeon 7720.5
- For train wheel pivots, cup bearings, everywhere the oiler has to be positioned before depositing oil
- Capacity 100mm³



Code	Description	UOM	Price
A38402	Auto Oiler 5 - Bergeon 7720-5	EACH	£63.95

Oilers (Automatic - Spare Parts), Bergeon (New Style)



Automatic Oilers - Spare Parts - Bergeon Swiss - New Style

Bergeon recommend cleaning the reservoirs in an ultrasonic tank

Code	Description	UOM	Price
A37073	Metal Tube & Reservoir (No.1A & 5) Bergeon 7718DR	EACH	£18.25
A37074	Metal Tube & Reservoir (No.2A) Bergeon 7719DR	EACH	£18.95
A40003	Needle (No.1A) Bergeon 7718P	EACH	£14.85
A40004	Needle (No.2A) Bergeon 7719P	EACH	£12.95
A40005	Needle (No.5) Bergeon 7720P	EACH	£13.85



Oilers, Assorted in Wallet

A*F Swiss Set in Wallet

- A*F Swiss
- Set of 5
- Supplied in wallet
- Plastic oilers

- Tip Width:
- 0.15mm Black
 - 0.25mm Red
 - 0.35mm Blue
 - 0.45mm Green
 - 0.55mm Yellow



Code	Description	UOM	Price
O1051	A*F Swiss Set in Wallet	PACK*5	£7.50

Bergeon Swiss Box Set

- Bergeon 30102-4
- Set of 4
- Assortment of 4 oilers
- Partitioned sliding box
- Colour coded
- Plastic oilers



- Contents:
- Extra fine
 - Fine
 - Medium
 - Large

Code	Description	UOM	Price
O1049	Bergeon Swiss Box Set	PACK*4	£14.50

Bergeon Swiss Set In Wallet



- Bergeon 30102-S
- Assortment of 4 oilers
- Supplied in wallet
- Colour coded
- Plastic oilers

- Contents:
- Extra fine
 - Fine
 - Medium
 - Large

Code	Description	UOM	Price
O1050	Bergeon Swiss Set In Wallet	PACK*4	£8.25

Indian Set in Wallet

- Indian
- Set of 5
- Assortment of 5 oilers
- Supplied in wallet
- Plastic oilers



- Contents:
- Super Fine
 - Extra fine
 - Fine
 - Medium
 - Large

Code	Description	UOM	Price
O31269	Indian Set in Wallet	PACK*5	£4.95

Oilers, Bergeon



Oilers - Bergeon

- 1 needle oiler
- Bergeon 30102

(Fitted pin arrives the wrong way round, simply remove with pliers and fit the correct way round)

- Tip size
- Black* - 0.18mm Tip
 - Red* - 0.18mm Tip
 - Blue - 0.24mm Tip
 - Green - 0.45mm Tip
 - Yellow - 0.80mm Tip

* Black oiler without Bergeon livery (tip size the same)

Code	Description	UOM	Price
O50352	Super Fine (Black) Oiler	EACH	£2.50
O50353	Fine (Red) Oiler	EACH	£2.50
O50354	Fine (Blue) Oiler	EACH	£2.50
O50355	Medium (Green) Oiler	EACH	£2.50
O50356	Large (Yellow) Oiler	EACH	£2.50

Oilers (3 in 1) A*F Swiss



Oilers - A*F Swiss

- 3 in 1 (2 spares in handle)
- Plastic
- Swiss Made
- A*F Swiss

(Fitted pin arrives the wrong way round, simply remove with pliers and fit the correct way round)

- Tip size
- Black* - 0.18mm Tip
 - Red* - 0.18mm Tip
 - Blue - 0.24mm Tip
 - Green - 0.45mm Tip
 - Yellow - 0.80mm Tip

* Choice of colour (tip size the same)

Code	Description	UOM	Price
O1044	Super Fine (Black) Oiler	EACH	£3.75
O1047	Super Fine (Red) Oiler	EACH	£3.75
O1045	Fine (Blue) Oiler	EACH	£3.75
O1046	Medium (Green) Oiler	EACH	£3.75
O1048	Large (Yellow) Oiler	EACH	£3.75

Oilers (3 in 1) Bergeon



Oilers - Bergeon Swiss

- Fitted pin arrives the wrong way round, simply remove with pliers and fit the correct way round
- Tip size: 0.18mm
- Plastic

Code	Description	UOM	Price
O7619	Super Fine (Black) Oiler, Bergeon	EACH	£4.45
N7615	Super Fine (Black) Oiler Needle, Bergeon	EACH	£1.25

Oilers (3 in 1) Incabloc, Specialist



Horotec Swiss Made - Precision Incabloc Oiler

- Super fine needle
- Supplied with 4 needles (3 stored in the oiler body)
- Fitted needle supplied the wrong way round, simply remove and reverse
- Reversible needle
- Aluminium gold hexagonal handle
- Handle Ø6mm

Code	Description	UOM	Price
O49486	Incabloc Oiler	EACH	£10.50
O49487	Incabloc Oiler Needle	EACH	£2.50

Oilers (Ergonomic) Bergeon



Oilers - Bergeon Swiss

Bergeon Oilers HH (Haute Horlogerie)

High precision needles, in stainless steel, electropolished. Ergonomic handle with coloured rings for identification and perfect grip. Specially adapted for all precision oiling.

- Very good hold of the drop
- Repeatability of the oil's quantity
- Precision of the drop's deposit
- Synthetic handle, antistatic
- Set of 4 our codes O1049 & O1050
- Swiss Made

Tip size

- Black* - 0.18mm Tip (Bergeon 7013-N)
- Red* - 0.18mm Tip (Bergeon 7013-R)
- Blue - 0.24mm Tip (Bergeon 7013-B)
- Green - 0.32mm Tip (Bergeon 7013-V)
- Yellow - 0.45mm Tip (Bergeon 7013-J)

* Choice of colour (tip size the same)

Code	Description	UOM	Price
S32250	Bergeon Set of 4 Ergonomic Watch Oilers	PACK*4	£74.95
S32251	Super Fine (Black) Bergeon Ergonomic	EACH	£19.75
S32252	Super Fine (Red) Bergeon Ergonomic	EACH	£19.75
S32253	Fine (Blue) Bergeon Ergonomic	EACH	£19.75
S32254	Medium (Green) Bergeon Ergonomic	EACH	£19.75
S32255	Large (Yellow) Bergeon Ergonomic	EACH	£19.75

Oilers (Single Blade)

VALUE



Oilers - Indian

- Single Bladed Oilers
- Ideal for students
- Plastic
- Indian Made

Code	Description	UOM	Price
O36099	Ø0.20mm (Red) Oiler - Super Fine	EACH	£0.95
O36100	Ø0.22mm (Blue) Oiler - Extra Fine	EACH	£0.95
O36114	Ø0.30mm (Black) Oiler - Fine	EACH	£0.95
O36101	Ø0.40mm (Yellow) Oiler - Medium	EACH	£0.95
O36115	Ø0.50mm (Green) Oiler - Large	EACH	£0.95



ONLINE ORDER STATUS

Hairspring Degreaser Cleaning Fluid

See Page 1253



Oiler Stand, Cousins

COUSINSUK



Oiler Stand

- High quality oiler stand
- Ceramic oil wells
- Anodised aluminium oil cups
- High quality in anodized aluminium base
- Rotating base
- 5 Colour coded oiler cups & pith woods
- Space for 4 oilers
- Cousins UK

Code	Description	UOM	Price
O53093	Oiler Stand, CousinsUK	EACH	£114.95

Oiler Set, Bergeon 6875

BERGEON



Oiler Set - Bergeon Swiss

- 5 oilers, 5 oil cups & 5 pith wood buttons
- Agate oil wells
- Anodised aluminium oil cups
- Anodised aluminium oiler handles
- High quality in anodized aluminium base
- Rotating base with bronze bearings
- Colour coded oilers, cups & pith woods
- Bergeon 6875

Includes:

- Ø6mm well & oiler
- Ø8mm well & oiler
- Ø9mm well & oiler
- Ø10mm well & oiler
- Ø16mm well & oiler

Code	Description	UOM	Price
O47447	Oiler Set, Bergeon 6875	EACH	£515.00

ONLINE QUOTES



Oiler Set, Bergeon 31226.A

BERGEON



Bergeon 31226.A - Swiss Made

- Assortment of 4 oilers
- Supplied on heavy duty chrome base
- With 4 pith wood buttons
- Colour coded
- Plastic oilers

Contents:

- Extra fine
- Fine
- Medium
- Large

Code	Description	UOM	Price
O47449	Bergeon Swiss Set on Stand	PACK*4	£119.95

Oiler Set, Horotec 17.103

HOROTEC



Horotec 17.103 - Swiss Made

- Assortment of 4 oilers & reservoirs
- Shot blasted, anodised aluminium base
- With 4 white ceramic oil reservoirs
- 4 Aluminium oilers, Ø6mm
- Colour coded oilers & reservoirs
- Horotec 17.103

Contents:

- Extra fine
- Fine
- Medium
- Large

Code	Description	UOM	Price
B55902	Oiler Set, Horotec 17.103	EACH	£139.95

Watch Oils

See Page 1268



Oiler Set, Value

VALUE



Oiler Set

- Set of 4 oilers & 4 oil cups
- Plastic oilers & cups
- Supplied with wooden stand
- Excellent value

Oilers included: Super Fine (Black), Extra fine (Red), Fine (Blue), Medium (Green)
Oil cups included: Black (Ø8mm), Blue (Ø10mm), Green (Ø14mm), Red (Ø17mm)

Code	Description	UOM	Price
038658	Single Oilers & Cups Set	EACH	£7.50

OMEGA SPECIFIC

Omega Tools

Co-Axial Regulating (Square), Cousins



CousinsUK - Non Swiss

For adjusting the balance wheel of Omega movements for co-axial calibres listed below that require a square timiny key.

- Square timing key for all co-axial Omega movements
- For all co axial movements including calibres: 2300A, 2500A, 2500B, 2500C, 2610A, 2627A, 2628B, 3301A, 3303A, 3313B, 3603A, 3890A and similar

Code	Description	UOM	Price
X32818	Co-Axial Regulating (Square), Cousins	EACH	£44.95

OVER 130,000 DIFFERENT ITEMS

Moebius Fixodrop Special Bottle

See Page 1261



Co-Axial Regulating (Square), Omega Swiss

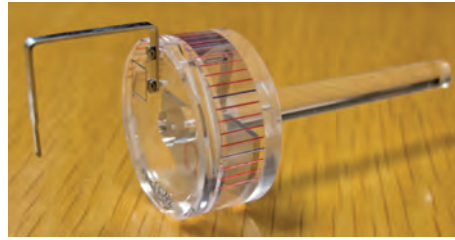

Omega - Swiss Made

For adjusting the balance wheel of Omega movements for co-axial calibres listed below that require a square timiny key.

- Square timing key for all co-axial Omega movements
- For all co axial movements including calibres: 2300A, 2500A, 2500B, 2500C, 2610A, 2627A, 2628B, 3301A, 3303A, 3313B, 3603A, 3890A and similar

Code	Description	UOM	Price
X30550	Co-Axial Regulating (Square), Omega Swiss	EACH	£239.95

Co-Axial Regulating (Tork), Cousins



CousinsUK - Non Swiss

For adjusting the balance wheel of Omega movements for co-axial calibres listed below that require a torx timiny key.

- Torx timing key for all co-axial Omega movements
- For all co axial movements including calibres: 8500 & 8501 and similar

Code	Description	UOM	Price
M44369	Co-Axial Regulating (Tork), Cousins	EACH	£44.95

Co-Axial Regulating (Tork), Omega Swiss

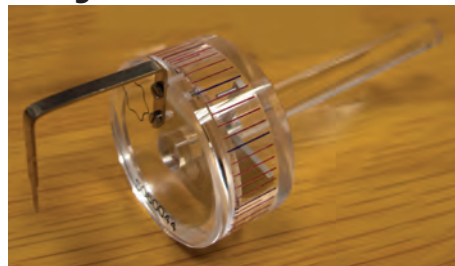

Omega - Swiss Made

For adjusting the balance wheel of Omega movements for co-axial calibres listed below that require a torx timiny key.

- Torx timing key for all co-axial Omega movements
- For all co axial movements including calibres: 8500 & 8501 and similar

Code	Description	UOM	Price
X29133	Co-Axial Regulating (Tork), Omega Swiss	EACH	£299.95

Die (Case Back) Planet Ocean Ø33.30mm, Omega Swiss

Omega 508 0013



Code	Description	UOM	Price
X21126	Die (Case Back) Planet Ocean Ø33.30mm, Omega Swiss		£0.00

Ø20mm (Omega Seamaster) Horotec, Universal



Horotec 07.330.020
• 5 Pin Metal Die



Universal Fitting Dies for Tools:

- Bergeon Swiss
- Horotec Swiss
- Swiss Style

Fitting:

- Universal = dies fit directly on to the tools

Code	Description	UOM	Price
M19220	Ø20mm (Omega Seamaster) Horotec, Universal	EACH	£23.50

Ø30mm (Omega Seamaster) Horotec, Universal



Horotec 07.330.030
• 5 Pin Metal Die



Universal Fitting Dies for Tools:

- Bergeon Swiss
- Horotec Swiss
- Swiss Style

Fitting:

- Universal = dies fit directly on to the tools

Code	Description	UOM	Price
M19221	Ø30mm (Omega Seamaster) Horotec, Universal	EACH	£28.95

Die (Case Back) Seamaster Ø20mm, Omega Swiss



Omega 508 0012

- For opening and closing Omega "Seamaster" case backs
- Metal die



Code	Description	UOM	Price
X15210	Die (Case Back) Seamaster Ø20mm, Omega Swiss	EACH	£90.94

www. Online Discounts

PRICE PROMISE GUARANTEE

Die (Case Back) Seamaster Ø30mm, Omega Swiss

- Omega 508 0011
- For opening and closing Omega "Seamaster" case backs
- Metal die



Code	Description	UOM	Price
X9550D	Die (Case Back) Seamaster Ø30mm, Omega Swiss	EACH	£90.94

Die Holder Plus Ø20 & 30mm Dies, Horotec



Horotec Swiss 07.304 (M19219) is supplied with a Die Holder & 2 metal dies (5 pins) Ø20 & 30mm for Omega Seamaster ladies & Gents case backs. The dies will also fit any of our universal case back tools listed below.

- Universal Fitting Dies for Tools:
- Bergeon Swiss
 - Horotec Swiss
 - Swiss Style

Fitting:
• Universal = dies fit directly on to the tools listed above

Code	Description	UOM	Price
M19219	Die Holder Plus Ø20 & 30mm Dies, Horotec	EACH	£79.95

Extractor Tube Set



- Omega 5100051
- Used for Seamaster X-33 Crown & Pusher Tubes Helium Valve and De-Ville Co-Axial Tubes
- Will also remove other helium valves (for fitting helium valves see tool X12513)

Instructions for Use:

- Take the Extractor in the hand wrench
- Insert the extractor inside the screwed Tube
- Force the extractor while turning Anti Clockwise
- With the help of the extractor
- Pull out the screwed tube in the direction it rotates
- Then screw out
- Once separated from the watch case
- Release the screwed tube from the extractor
- Block the body firmly with pliers and turn extractor clockwise
- Remove the titanium gasket
- Gasket can be released with small screwdriver

- By pressing from inside of it's seating
- Clean the residues of glue in the hole with a tap
- Burrs and remaining glue inside case clean with Mill Cutter
- Fit New Titanium gasket on the screw tube
- Cover the thread of the new screw tube with Loctite 243 (Product Code C20803)
- And screw it with specific key in the middle of case
- Allow to dry 24 hours

Code	Description	UOM	Price
X22225	Extractor Tube Set	EACH	£59.95

Helium Valve Fitting Tool



- Model 1993
- 1503-825
- Omega valve part number 086.0061
- For fitting the helium valve pusher
- For extracting helium valves see tool X22225

Code	Description	UOM	Price
X12513	Helium Valve Fitting Tool	EACH	£68.50

Regatta Extractor Tube Key



- Omega 5100356
- 8 sided key for crown tube
- Case Number 177.0519
- Necessary for the re-fitting of the threaded pendant tubes

A specific tube key is required for it's proper return without damage to the working surfaces.

Code	Description	UOM	Price
X24097	Regatta Extractor Tube Key	EACH	£72.00

Tap 5024100901 for Omega M2.5 x 0.25



Code	Description	UOM	Price
X24098	Tap 5024100901 for Omega M2.5 x 0.25	EACH	£34.25



ROLEX SPECIFIC

Microstella Regulating Tool for Rolex Balances



Horotec 03.670

Micro-stella key used to adjust Rolex balance wheels. The tool fits the unique star head of the balance adjusting screws. Screwing in gives faster rate, screwing out slower rate.

- Calibres 2130, 3035, 3055, 3135, 3155 and similar
- Includes instructions

Code	Description	UOM	Price
R8717	Microstella Regulating Tool for Rolex Balances	EACH	£24.95

Rolex Calibre Movement Holders



Watch movement holders for specific Rolex calibres.

Horotec Swiss

Code	Description	UOM	Price
M9672	Movement Holder Cal. 1570	EACH	£12.50
M9673	Movement Holder Cal. 2135	EACH	£13.95
M9674	Movement Holder Cal. 3035	EACH	£14.50

Oscillating Rotor Weight Axle Punches



For Specific Rolex Calibres - Horotec Swiss

- For fitting & removing weight axles
- Improved version
- Swiss made
- Pack*4
- Replacements available
- Horotec 03.666

Set contains:

- Calibre 1570 punch
- Calibre 2130 & 2135 punch
- Calibre 2235 punch

• Calibre 3035 & 3135 punch

Code	Description	UOM	Price
R44356	Axle Punch Set	PACK*4	£56.95
R15264	Calibre 1570 Axle Punch	EACH	£17.25
R15265	Calibre 2130 & 2135 Axle Punch	EACH	£17.50
R15266	Calibre 2235 Axle Punch	EACH	£17.95
R15267	Calibre 3035 & 3135 Axle Punch	EACH	£18.50

Taps for Rolex Pendant Tubes

VALUE



Taps for Rolex Pendant Tubes

- These taps are made specifically to help you re-align the threads of Rolex case tubes
- Ensures a proper fit
- High speed steel (HSS)

Sizes:

- T52795: Ø2.50 x 0.25 (Thread x Pitch) - For Ø5.30mm Rolex tubes
- T52796: Ø3.00 x 0.35 (Thread x Pitch) - For Ø6.00mm Rolex tubes

Code	Description	UOM	Price
T52795	Ø2.50 x 0.25 Tap	EACH	£7.95
T52796	Ø3.00 x 0.35 Tap	EACH	£7.95

Thread Cutting Tools

COUSINSUK



- Tool to easily cut the thread on Rolex cases
- Popular Rolex Oyster case sizes
- Ø5.30 or Ø6.00mm
- Stainless steel handles
- Thread x pitch (Rolex tube size)

Code	Description	UOM	Price
R44747	Ø2.50 x 0.25mm Tap Tool (For Ø5.30mm Rolex Tubes)	EACH	£40.95
R44748	Ø3.00 x 0.35mm Tap Tool (For Ø6.00mm Rolex Tubes)	EACH	£42.50

ONLINE CATALOGUES

PRICE PROMISE GUARANTEE

ALL FEEDBACK WELCOME

SCREW EXTRACTION

Screw Extractor

BERGEON



Bergeon 30209 - Swiss Made

Removal of damaged watch screws with precise alignment of special milled tips and support.

- Supplied with 1 x removable double ended driving extractor (S1520), Ø0.80 & Ø1.00mm
- Handle extractor Ø0.80mm

Reversible Screw Extractors:

- 30209A = Ø0.40mm & Ø0.50mm
- 30209B = Ø0.60mm & Ø0.70mm
- 30209C = Ø0.80mm & Ø1.00mm

Code	Description	UOM	Price
S1517	Screw Extractor Tool	EACH	£62.95
S1518	Ø0.40mm & Ø0.50mm Extractor, Bergeon 30209A	EACH	£8.75
S1519	Ø0.60mm & Ø0.70mm Extractor, Bergeon 30209B	EACH	£8.75
S1520	Ø0.80mm & Ø1.00mm Extractor, Bergeon 30209C	EACH	£8.75

STAKING SETS, BLOCKS & PUNCHES

Staking & Riveting Blocks



Large selection of staking blocks are available for watchmakers, clockmakers and jewellers as it can be used as a base for riveting & drilling or for bushing & closing holes.

All steel staking blocks are case hardened and well polished to ensure a long life. We have

various types from 9 holes to 36 holes and some have machined slits incorporated.

9 Hole

- Ø50mm
- 11mm Thick
- Holes: Ø3 to 10mm
- Steel

VALUE



Code	Description	UOM	Price
S32058	Riveting Round Stake with 9 Holes	EACH	£2.75

9 Hole with V

- 9 holes from Ø0.80 to Ø4.00mm
- With V stake
- 4 Serrations
- Steel
- Made in India

VALUE



Code	Description	UOM	Price
S36502	Riveting Stake with V Stake	EACH	£4.95

9 Hole, Brass

- Brass body Ideal for protecting soft clock parts
- 9 holes from Ø1.50 to Ø6.00mm
- With added feature of opening slide action
- 73 x 25 x 13mm

VALUE

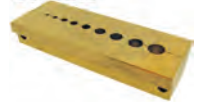

Code	Description	UOM	Price
S9729	Split 9 Hole Riveting Stake	EACH	£10.90

15 Hole

- Holes from Ø0.90 to Ø6.10mm
- 5 Slots
- 55 x 45 x 18mm
- Steel
- Made in India

VALUE



Code	Description	UOM	Price
S36482	Riveting Stake, 15 Hole, Indian	EACH	£4.95

15 Hole, Bergeon 1907

- With holes from Ø0.80 to Ø6.30mm
- 4 Slots
- Size: 46 x 46 x 15mm
- Steel
- Bergeon Swiss

BERGEON



Code	Description	UOM	Price
S1539	Bergeon 1907 15 Hole Riveting Stake	EACH	£81.80

Hole Closing & Riveting Clock Punches

See Page 698



15 Hole, Bergeon 30205

- With holes from Ø2.00 to Ø8.60mm
- 4 Slots
- Size: 65 x 45 x 20mm
- Steel
- Bergeon Swiss



Code	Description	UOM	Price
S7679	Bergeon 30205 15 Hole Riveting Stake	EACH	£62.95

24 Hole, Bergeon 1901

- With holes from Ø0.50 to Ø2.20mm
- Steel
- Bergeon Swiss



Code	Description	UOM	Price
S1537	Bergeon 1901 24 Hole Riveting Stake	EACH	£25.25

36 Hole

- 2 Sizes
- 36 hole staking blocks
- Steel
- Made in India



Dimensions:

- Smallest hole size to maximum hole size (plate size)

Code	Description	UOM	Price
S47502	Ø0.25 to 2.35mm Holes (55 x 20 x 5mm)	EACH	£3.50
S47501	Ø0.50 to 3.75mm Holes (75 x 25 x 10mm)	EACH	£3.85

36 Hole, Bergeon 1902

- With holes from Ø0.50 to Ø2.50mm
- Steel
- Bergeon Swiss



Code	Description	UOM	Price
S1538	Bergeon 1902 36 Hole Riveting Stake	EACH	£26.75

Staking Sets

Staking Set

VALUE



Contents:

- 1 Staking tool
- 120 punches, tempered steel for extra strength
- 20 stakes
- Punches are diameter Ø5mm
- Wooden storage box with additional storage draw
- Made in India

Code	Description	UOM	Price
S39653	Staking Set	EACH	£259.95

Staking Set - Bergeon 1808.92A (made by Star)



"Star" and "Bergeon" collaboration has produced this excellent and practical version comprising of a nickel plated cast stake holder frame with lockable rotating stake plate. Bergeon Swiss, made by Star.

Contents:

- 1 Staking tool
- 105 punches
- 20 stakes
- Strong wooden storage box

Code	Description	UOM	Price
S1543	Bergeon 1808-92A Staking Set	EACH	£595.00

Staking Set - Bergeon 4765-140.92 (made by Star)



"Star" and "Bergeon" collaboration has produced this complete, comprehensive & excellent version comprising of a nickel plated cast stake holder frame with lockable rotating stake plate. With height adjustable micrometer base, which enables the punches to be fitted instead of the stakes. Bergeon Swiss, made by Star.

Contents:

- 1 Staking tool
- 105 punches
- 25 stakes
- 12 Pushers
- 15 reamers
- 2 chamfering tools
- Strong wooden storage box

Code	Description	UOM	Price
S49897	Staking Set, Bergeon 4765.140.92	EACH	£1,250.00

Staking Set - Bergeon 5285B



Bergeon 5285B staking set.

- Die cast alloy
- Matt chromed
- Adjustable tube Ø4.70mm
- Knurled nut enables adjustment of shake
- All punches and stakes are fitted in a numbered gilded metal plate
- Each punch is likewise numbered
- A special cap enables gripping of punches for removal
- Please see PDF above for full specification
- Bergeon 5285B

Contents:

- 1 Staking tool
- 50 punches
- 10 stakes

Online Discounts

Cousins Watchmakers & Jewellers Hammers

"Excellent Quality"

See Page 807



- Strong wooden storage box

Code	Description	UOM	Price
S7684	Bergeon 5285B Staking Tool	EACH	£439.95

Staking Set - Bergeon 5285D



Comprehensive Bergeon 5285D staking set

- Die cast alloy
- Matt chromed
- Adjustable tube Ø4.70mm
- Knurled nut enables adjustment of shake
- All punches and stakes are fitted in a numbered gilded metal plate
- Each punch is likewise numbered
- A special cap enables gripping of punches for removal
- Please see PDF above for full specification
- Bergeon 5285D

Contents:

- 1 Staking tool
- 1 Staking tool base
- 100 punches
- 20 stakes
- Strong wooden storage box

Code	Description	UOM	Price
S1541	Bergeon 5285D Staking Tool	EACH	£845.00

Staking Set Spindle, Collets & Stop Ring, Bergeon



Bergeon 30601-127-131

- Staking Set Spindle, Collets & Stop Ring
- Fits Bergeon staking frame and features a set of 4 collets
- With an adjustable stop ring give depth control
- Collets Ø: 0.80mm, 1.00mm, 1.20mm and 1.50mm capacity

Code	Description	UOM	Price
S7683	Spindle, Collets & Stop Ring, Bergeon 30601-127-131	EACH	£107.95

Staking Tool, Bergeon 5285



- Bergeon 5285
- Staking Tool (Base not included)
- Die cast iron press
- Matt chromed
- Fine workmanship
- Adjustable tube
- Ø4.7mm
- Knurled nut enables adjustment of shake

Code	Description	UOM	Price
S8293	Staking Tool, Bergeon 5285	EACH	£139.95

Staking Tool Base, Bergeon 5285S

- Bergeon 5285S
- Staking tool base
- Raising the staking tool allows the use of punches as stakes



Code	Description	UOM	Price
S1542	Tool Base, Bergeon 5285S	EACH	£60.95

Staking Tool Plate, Bergeon 5285-PLT

- Bergeon 5285-PLT
- Staking Tool Plate



Code	Description	UOM	Price
S23372	Staking Tool Plate, Bergeon 5285-PLT	EACH	£59.95

WORLDWIDE DELIVERY



PRICE PROMISE GUARANTEE

Staking Set Individual Punches

Staking Punch Cap

Bergeon 5285G - Swiss Made

- A special cap enables gripping of punches for removal



Code	Description	UOM	Price
P7647	Punch Cap, Bergeon 5285G	EACH	£4.95

Centering Spindle Staking Punch

Bergeon - Swiss Made

- Punch Ø4.7mm
- The last 3 digits of Bergeon 5285 *** is stamped on the original and replacement Punch



Code	Description	UOM	Price
P7637J	293 Punch, Bergeon 5285	EACH	£5.75

Chamfering Staking Punch

Bergeon - Swiss Made

- Punch Ø4.7mm
- The last 3 digits of Bergeon 5285 *** is stamped on the original and replacement Punch.



Code	Description	UOM	Price
P7639	296 (Ø1.00mm) Punch, Bergeon 5285	EACH	£9.85
P7639A	297 (Ø2.00mm) Punch, Bergeon 5285	EACH	£9.85
P7639B	298 (Ø3.00mm) Punch, Bergeon 5285	EACH	£9.85
P7639C	299 (Ø4.00mm) Punch, Bergeon 5285	EACH	£9.85

Concaved Drilled Staking Punch

Bergeon - Swiss Made

- Punch Ø4.7mm
- The last 3 digits of Bergeon 5285 *** is stamped on the original and replacement Punch



Bergeon 5285-235 to 247
• Sizes: Hole Ø x Outer Ø

Code	Description	UOM	Price
P7635	235 (Ø0.40mm x Ø2.00mm) Bergeon	EACH	£4.95
P31034	236 (Ø0.45mm x Ø2.10mm) Bergeon	EACH	£4.95
P7635B	237 (Ø0.50mm x Ø2.20mm) Bergeon	EACH	£4.95
P7635C	238 (Ø0.60mm x Ø2.40mm) Bergeon	EACH	£4.95
P7635D	239 (Ø0.70mm x Ø2.60mm) Bergeon	EACH	£4.95

OVER 130,000 DIFFERENT ITEMS

P31035	240 (Ø0.80mm x Ø2.80mm) Bergeon	EACH	£4.95
P31036	241 (Ø0.90mm x Ø3.00mm) Bergeon	EACH	£4.95
P7635G	242 (Ø1.00mm x Ø3.20mm) Bergeon	EACH	£4.95
P31037	243 (Ø1.20mm x Ø3.40mm) Bergeon	EACH	£4.95
P30597	244 (Ø1.40mm x Ø3.60mm) Bergeon	EACH	£4.95
P7635J	245 (Ø1.60mm x Ø3.70mm) Bergeon	EACH	£4.95
P31038	246 (Ø1.80mm x Ø3.80mm) Bergeon	EACH	£4.95
P7635L	247 (Ø2.00mm x Ø4.00mm) Bergeon	EACH	£4.95

Domed Drilled Staking Punch

Bergeon - Swiss Made

- Punch Ø4.7mm
- The last 3 digits of Bergeon 5285 *** is stamped on the original and replacement Punch



Bergeon 5285-248 to 272
• Sizes: Hole Ø x Outer Ø

Code	Description	UOM	Price
P7635M	248 (Ø0.30 x Ø1.30mm) Bergeon	EACH	£4.95
P31039	249 (Ø0.35 x Ø1.35mm) Bergeon	EACH	£4.95
P7635O	250 (Ø0.40 x Ø1.40mm) Bergeon	EACH	£4.95
P7635P	251 (Ø0.45 x Ø1.45mm) Bergeon	EACH	£4.95
P7635Q	252 (Ø0.50 x Ø1.50mm) Bergeon	EACH	£4.95
P7635R	253 (Ø0.55 x Ø1.55mm) Bergeon	EACH	£4.95
P7635S	254 (Ø0.60 x Ø1.60mm) Bergeon	EACH	£4.95
P7635T	255 (Ø0.65 x Ø1.65mm) Bergeon	EACH	£4.95
P21971	256 (Ø0.70 x Ø1.70mm) Bergeon	EACH	£4.95
P31040	257 (Ø0.75 x Ø1.75mm) Bergeon	EACH	£4.95
P31041	258 (Ø0.80 x Ø1.80mm) Bergeon	EACH	£4.95
P31042	259 (Ø0.85 x Ø1.85mm) Bergeon	EACH	£4.95
P7635Y	260 (Ø0.90 x Ø1.90mm) Bergeon	EACH	£4.95
P7635Z	261 (Ø0.95 x Ø1.95mm) Bergeon	EACH	£4.95
P7635ZA	262 (Ø1.00 x Ø2.00mm) Bergeon	EACH	£4.95
P7635ZB	263 (Ø1.10 x Ø2.10mm) Bergeon	EACH	£4.95
P19764	264 (Ø1.20 x Ø2.20mm) Bergeon	EACH	£4.95
P7635ZD	265 (Ø1.30 x Ø2.30mm) Bergeon	EACH	£4.95
P19767	266 (Ø1.40 x Ø2.40mm) Bergeon	EACH	£4.95
P7635ZF	267 (Ø1.50 x Ø2.50mm) Bergeon	EACH	£4.95
P19765	268 (Ø1.60 x Ø2.60mm) Bergeon	EACH	£4.95
P19766	269 (Ø1.80 x Ø2.80mm) Bergeon	EACH	£4.95
P31043	270 (Ø2.00 x Ø3.00mm) Bergeon	EACH	£4.95
P31044	271 (Ø2.20 x Ø3.20mm) Bergeon	EACH	£4.95
P19228	272 (Ø2.50 x Ø3.50mm) Bergeon	EACH	£4.95

Domed Undrilled Staking Punch

Bergeon - Swiss Made

- Punch Ø4.7mm
- The last 3 digits of Bergeon 5285 *** is stamped on the original and replacement Punch



Code	Description	UOM	Price
P7636	273 (Ø1.00mm) Bergeon	EACH	£5.95
P7636A	274 (Ø1.30mm) Bergeon	EACH	£5.95
P7636B	275 (Ø1.50mm) Bergeon	EACH	£5.95
P31045	276 (Ø1.70mm) Bergeon	EACH	£5.95
P7636D	277 (Ø1.90mm) Bergeon	EACH	£5.95

P7636E	278 (Ø2.00mm) Bergeon	EACH	£5.95
P7636F	279 (Ø2.40mm) Bergeon	EACH	£5.95
P21972	280 (Ø2.70mm) Bergeon	EACH	£5.95
P7636H	281 (Ø3.00mm) Bergeon	EACH	£5.95
P30596	282 (Ø4.00mm) Bergeon	EACH	£5.95

Flat Drilled Staking Punch

Bergeon - Swiss Made

- Punch Ø4.7mm
- The last 3 digits of Bergeon 5285 *** is stamped on the original and replacement Punch



Bergeon 5285-200 to 224
• Sizes: Hole Ø x Outer Ø

Code	Description	UOM	Price
P7633	200 (Ø0.30mm x Ø1.30mm) Bergeon	EACH	£4.95
P7633A	201 (Ø0.35mm x Ø1.35mm) Bergeon	EACH	£4.95
P7633B	202 (Ø0.40mm x Ø1.40mm) Bergeon	EACH	£4.95
P7633C	203 (Ø0.45mm x Ø1.45mm) Bergeon	EACH	£4.95
P7633D	204 (Ø0.50mm x Ø1.50mm) Bergeon	EACH	£4.95
P7633E	205 (Ø0.55mm x Ø1.55mm) Bergeon	EACH	£4.95
P7633F	206 (Ø0.60mm x Ø1.60mm) Bergeon	EACH	£4.95
P7633G	207 (Ø0.65mm x Ø1.65mm) Bergeon	EACH	£4.95
P7633H	208 (Ø0.70mm x Ø1.70mm) Bergeon	EACH	£4.95
P7633I	209 (Ø0.75mm x Ø1.75mm) Bergeon	EACH	£4.95
P7633J	210 (Ø0.80mm x Ø1.80mm) Bergeon	EACH	£4.95
P7633K	211 (Ø0.90mm x Ø1.90mm) Bergeon	EACH	£4.95
P7633L	212 (Ø1.00mm x Ø2.00mm) Bergeon	EACH	£4.95
P7633M	213 (Ø1.10mm x Ø2.10mm) Bergeon	EACH	£4.95
P7633N	214 (Ø1.20mm x Ø2.20mm) Bergeon	EACH	£4.95
P7633O	215 (Ø1.50mm x Ø2.30mm) Bergeon	EACH	£4.95
P31030	216 (Ø1.40mm x Ø2.40mm) Bergeon	EACH	£4.95
P7633Q	217 (Ø1.50mm x Ø2.50mm) Bergeon	EACH	£4.95
P7633R	218 (Ø1.60mm x Ø2.60mm) Bergeon	EACH	£4.95
P31031	219 (Ø1.70mm x Ø2.70mm) Bergeon	EACH	£4.95
P7633T	220 (Ø1.90mm x Ø2.90mm) Bergeon	EACH	£4.95
P31032	221 (Ø2.00mm x Ø3.00mm) Bergeon	EACH	£4.95
P31033	222 (Ø2.20mm x Ø3.20mm) Bergeon	EACH	£4.95
P7633W	223 (Ø2.40mm x Ø3.40mm) Bergeon	EACH	£4.95
P7633X	224 (Ø2.60mm x Ø3.60mm) Bergeon	EACH	£4.95



Flat Undrilled Staking Punch

Bergeon - Swiss Made

- Punch Ø4.7mm
- The last 3 digits of Bergeon 5285 *** is stamped on the original and replacement Punch



Code	Description	UOM	Price
P7634	225 (Ø1.00mm) Bergeon	EACH	£4.95
P7634A	226 (Ø1.20mm) Bergeon	EACH	£4.95
P7634B	227 (Ø1.40mm) Bergeon	EACH	£4.95
P7634C	228 (Ø1.60mm) Bergeon	EACH	£4.95
P7634D	229 (Ø1.80mm) Bergeon	EACH	£4.95
P7634E	230 (Ø2.20mm) Bergeon	EACH	£4.95
P7634F	231 (Ø2.60mm) Bergeon	EACH	£4.95
P7634G	232 (Ø3.00mm) Bergeon	EACH	£4.95
P7634H	233 (Ø3.70mm) Bergeon	EACH	£4.95
P7634I	234 (Ø4.20mm) Bergeon	EACH	£4.95

Screw Removing Staking Punch

Bergeon - Swiss Made

- Punch Ø4.7mm
- The last 3 digits of Bergeon 5285 *** is stamped on the original and replacement Punch



Code	Description	UOM	Price
P7637	283 (Ø0.30mm) Bergeon	EACH	£5.75
P7637A	284 (Ø0.40mm) Bergeon	EACH	£5.75
P50878	118A (Ø0.45mm) Bergeon	EACH	£5.75
P7637B	285 (Ø0.50mm) Bergeon	EACH	£5.75
P7637C	286 (Ø0.60mm) Bergeon	EACH	£5.75
P7637D	287 (Ø0.70mm) Bergeon	EACH	£5.75
P7637E	288 (Ø0.80mm) Bergeon	EACH	£5.75
P7637F	289 (Ø0.90mm) Bergeon	EACH	£5.75
P7637G	290 (Ø1.00mm) Bergeon	EACH	£5.75
P7637H	291 (Ø1.20mm) Bergeon	EACH	£5.75
P7637I	292 (Ø1.50mm) Bergeon	EACH	£5.75

Triangular Staking Punch

Bergeon - Swiss Made

- Punch Ø4.7mm
- The last 3 digits of Bergeon 5285 *** is stamped on the original and replacement Punch

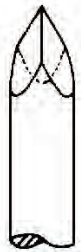

Code	Description	UOM	Price
P7638	294 (Ø3.50mm) Bergeon	EACH	£5.95
P7638A	295 (Ø4.70mm) Bergeon	EACH	£7.25

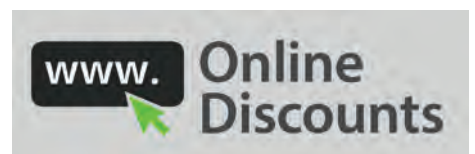

Stake, Concave

Bergeon - Swiss Made

- Bergeon 5285 -
 • 314 (Ø3.00mm) Stake
 • 315 (Ø5.00mm) Stake
 • 316 (Ø7.00mm) Stake



Code	Description	UOM	Price
P15261	314 (Ø3.00mm) Stake	EACH	£3.65
P31047	315 (Ø5.00mm) Stake	EACH	£3.65
P31048	316 (Ø7.00mm) Stake	EACH	£3.65

Stake, Domed Undrilled

Bergeon - Swiss Made

- Bergeon 5285 -
 • 311 (Ø3.00mm) Stake
 • 312 (Ø5.00mm) Stake

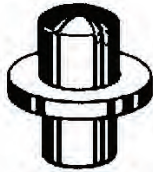

Code	Description	UOM	Price
P7642A	311 (Ø3.00mm) Bergeon	EACH	£3.65
P7642B	312 (Ø5.00mm) Bergeon	EACH	£3.65

Stake, Flat Drilled

Bergeon - Swiss Made

- Bergeon 5285 -
 • 306 (Ø1.00 x Ø2.00mm) Bergeon
 • 307 (Ø1.50 x Ø3.00mm) Bergeon
 • 308 (Ø2.00 x Ø4.00mm) Bergeon
 • 309 (Ø2.00 x Ø5.00mm) Bergeon
 • 310 (Ø3.50 x Ø7.50mm) Bergeon
 • Sizes: Hole Ø x Outer Ø

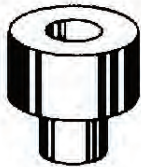

Code	Description	UOM	Price
P7641B	306 (Ø1.00 x Ø2.00mm) Bergeon	EACH	£3.65
P7641A	307 (Ø1.50 x Ø3.00mm) Bergeon	EACH	£3.65
P19768	308 (Ø2.00 x Ø4.00mm) Bergeon	EACH	£3.65
P31046	309 (Ø2.00 x Ø5.00mm) Bergeon	EACH	£3.65
P21958	310 (Ø3.50 x Ø7.50mm) Bergeon	EACH	£3.65

Stake, Flat Drilled, Brass

Bergeon - Swiss Made

- Bergeon 5285 -
 • 319 (Ø2.00mm x Ø7.00mm) Stake
 • Sizes: Hole Ø x Outer Ø

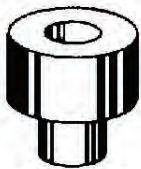

Code	Description	UOM	Price
P7646	319 (Ø2.00mm x Ø7.00mm) Stake	EACH	£3.65

Stake, Flat Drilled, Split

Bergeon - Swiss Made

- Bergeon 5285 -
 • 317 (Ø3.00 x Ø6.00mm) Bergeon
 • Sizes: Hole Ø x Outer Ø

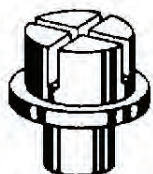

Code	Description	UOM	Price
P7644	317 (Ø3.00 x Ø6.00mm) Bergeon	EACH	£6.95

Stake, Flat Undrilled

Bergeon - Swiss Made

- Bergeon 5285 -
 • 300 (Ø2.00mm) Bergeon
 • 301 (Ø3.00mm) Bergeon
 • 302 (Ø4.00mm) Bergeon
 • 303 (Ø5.00mm) Bergeon
 • 304 (Ø7.00mm) Bergeon
 • 305 (Ø9.00mm) Bergeon



Code	Description	UOM	Price
P7640	300 (Ø2.20mm) Bergeon	EACH	£3.50
P7640A	301 (Ø3.00mm) Bergeon	EACH	£3.65
P7640C	302 (Ø4.00mm) Bergeon	EACH	£3.50
P7640D	303 (Ø5.00mm) Bergeon	EACH	£3.50
P7640E	304 (Ø7.00mm) Bergeon	EACH	£3.50
P7641	305 (Ø9.00mm) Bergeon	EACH	£3.50

Stake, Flat Undrilled, Brass

Bergeon - Swiss Made

- Bergeon 5285 -
 • 318 (Ø5.00mm) Bergeon



Code	Description	UOM	Price
P7645	318 (Ø5.00mm) Bergeon	EACH	£3.25

STEM CUTTERS AND OILERS

Stem Cutters



The specifically factory modified jaws (which give them an appearance of being out of alignment) actually ensure an even, perfect cut, when cutting watch stems from side on.

- High quality watch winding stem cutters
- A must for any manufacturer or repairer
- Provides a clean, flush cut
- Cut stems to required size
- Supplied with wooden box

Code	Description	UOM	Price
S41168	Stem Cutter	EACH	£78.50



Stem Cutter, Horotec Swiss



Horotec 03.602 - Swiss Made

- Excellent tool for precisely cutting one or multiple watch stems
- Micrometric screw, graduated in 1/10mm allows exact setting of cut length
- Blocking screw so the length can be kept the same for batch work
- Extra ruler etched on base, 0-15mm
- Suitable for tap 9, 10 or 12 (Ø0.90, 1.00 or 1.20mm) stems
- Specific holding groove for each tap size

Code	Description	UOM	Price
C44218	Stem Cutting Tool, Horotec Swiss	EACH	£274.95
C51717	Blade for Stem Cutter	EACH	£34.95

Stem Cutting Gauge, Bergeon Swiss



- Tool to measure stems precisely before cutting
- Excellent for batch work
- Rodin steel
- 33 x 23mm
- Bergeon 2002

Code	Description	UOM	Price
S46466	Stem Cutting Gauge, Bergeon 2002	EACH	£99.95



Stem Oiler, Bergeon Swiss



Bergeon 2678 - Bergeon Swiss

Rapidly and quickly ensures perfect oiling of all types of watch winding stems. The stem is placed on the lower pad and sandwiched by pressing down on the upper arm which springs back up after releasing.

- Tool specifically designed to ensure lubrication of the stem efficiently and easily
- Two (bottom and top) padded cushions
- Easy spring operation
- 80 x 40 x 60mm (L x W x H)

Code	Description	UOM	Price
040218	Winding Stem Oiler, Bergeon 2678	EACH	£74.95

Wheel, Hand & Roller Remover, Bergeon



Bergeon 6016 - Swiss Made
 • Fork shape
 • Ø1.20 mm

- The practical tool for removing:
- Intermediate wheels
 - Minute and seconds hands
 - Transmission wheels of chronographs
 - The rollers

Code	Description	UOM	Price
W1851	Wheel Remover (Chrono Transmission) - Bergeon	EACH	£23.95

WATCH PUSHER OR TUBE REMOVING AND FITTING TOOLS

Corrector Setting Tool



Corrector Setting Tool

- Corrector setting tool
- Anodized brass, knurled handle
- Stainless steel head
- Black POM tip (replacement available)
- Overall length 60mm
- Horotec 03.018

Code	Description	UOM	Price
S55897	Corrector Setting Tool	EACH	£16.95
S55898	Tip for Corrector Tool	EACH	£5.95

Multi Function Fitting & Removing Tools, Horotec

Horotec Swiss - Choice of 3 multi-function tools

Removing & fitting functions:

- Chronograph pusher external splines
- Pendant tube internal splines
- Oscillating rotor weight bolts
- Battery covers for Swatch, Fossil etc.
- See website "more info" for individual tool information
- Replacement tube, pusher & bolt keys are available and interchangeable

4 Multi Function Tool, Horotec MSA 03.621



Horotec Swiss MSA 03.621

4 Multi Function Removing & Fitting Tool:

- 1 = Chronograph Pushers
- 2 = Pendant Tubes
- 3 = Oscillating Rotor Weight Bolts
- 4 = Battery Covers for Swatch, Fossil etc.

Consists of 18 interchangeable keys plus hand piece on stand (120 x 70 x 35mm)
 • Tube keys: Ø1.50, 1.80, 2.00, 2.65, 2.75, 2.95, 3.00 & 3.00mm (inverted)
 • Pusher keys: Ø3.00, 2.50, 3.60, 4.35 & 4.80mm
 • Oscillating weight bolt keys: 2892 & 7750
 • Swatc battery cover keys: Gents, ladies & medium

Code	Description	UOM	Price
P19224	4 Multi Function Tool, Horotec MSA 03.621	EACH	£187.95

3 Multi Function Tool, Horotec MSA 03.623



Horotec Swiss MSA 03.623

3 Multi Function Removing & Fitting Tool:

- 1 = Chronograph Pushers
- 2 = Pendant Tubes
- 3 = Oscillating Rotor Weight Bolts

Consists of 15 interchangeable keys plus hand piece on stand (120 x 70 x 35mm):
 • Tube keys: Ø1.50, 1.80, 2.00, 2.65, 2.75, 2.95, 3.00 & 3.00mm (inverted)
 • Pusher keys: Ø3.00, 2.50, 3.60, 4.35 & 4.80mm
 • Oscillating weight bolt keys: 2892 & 7750

Code	Description	UOM	Price
P19404	3 Multi Function Tool, Horotec MSA 03.623	EACH	£178.95

2 Multi Function Tool, Horotec MSA 03.622



Horotec Swiss MSA 03.622

TRAIN WHEEL REMOVING TOOLS

5 Spoke Wheel Remover, Bergeon

Bergeon 30638.3 - "Presto" Tools

- For removing wheels on third wheel arbors and for chronograph driving wheels with 5 spokes
- Blue handle



Code	Description	UOM	Price
W1850	Bergeon 5 Spoke Wheel Remover	EACH	£36.95

6 Spoke Wheel Remover, Bergeon

Bergeon 4079.3A - "Presto" Tools

- For removing wheels on third wheel arbors and for chronograph driving wheels with 6 spokes
- Red handle



Code	Description	UOM	Price
W1849	Bergeon 6 Spoke Wheel Remover	EACH	£45.50



3 Multi Function Removing & Fitting Tool:

- 1 = Chronograph Pushers
- 2 = Pendant Tubes

Consists of 13 interchangeable keys plus hand piece on stand (120 x 70 x 35mm)
 • Tube keys: Ø1.50, 1.80, 2.00, 2.65, 2.75, 2.95, 3.00 & 3.00mm (inverted)
 • Pusher keys: Ø3.00, 2.50, 3.60, 4.35 & 4.80mm

Code	Description	UOM	Price
P19254	2 Multi Function Tool, Horotec MSA 03.622	EACH	£145.00

Hand Piece, Horotec



Multi functional hand piece only for removing and fitting screw-on pushers or crown tubes, oscillating weight bolts and battery covers

- Horotec Swiss MSA 03.620-A

Code	Description	UOM	Price
P19255	Hand Piece, Horotec	EACH	£20.95

Oscillating Weight Bolt Key for 2892

- Horotec Swiss MSA03.620.2892
- For calibres ETA 2892, 2893, 2894 & 2895



Code	Description	UOM	Price
P38795	Oscillating Weight Bolt Key for 2892	EACH	£26.95

Oscillating Weight Bolt Key for 7750

- Horotec Swiss MSA03.620.7750
- For calibres Valjoux 7750 & ETA 2001.1



Code	Description	UOM	Price
P38796	Oscillating Weight Bolt Key for 7750	EACH	£25.95

Pusher Key, Ø3.00mm

- Horotec Swiss MSA03.620.P3



Code	Description	UOM	Price
P38792	Pusher Key, Ø3.00mm	EACH	£14.95

Pusher Key, Ø3.50mm

- Horotec Swiss MSA03.620.P27



Code	Description	UOM	Price
P38793	Pusher Key, Ø3.50mm	EACH	£14.95

Pusher Key, Ø3.60mm

- Horotec Swiss MSA03.620.P39



Code	Description	UOM	Price
P38794	Pusher Key, Ø3.60mm	EACH	£14.95

Pusher Key, Ø4.35mm

- Horotec Swiss MSA03.620.203



Code	Description	UOM	Price
P38790	Pusher Key, Ø4.35mm	EACH	£14.95

Pusher Key, Ø4.80mm

- Horotec Swiss MSA03.620.207



Code	Description	UOM	Price
P38791	Pusher Key, Ø4.80mm	EACH	£14.95

Swatch Battery Cover Key, Gents

- Horotec Swiss MSA03.620GENT
- Gents
- Ø14mm



Code	Description	UOM	Price
P38797	Swatch Battery Cover Key, Gents	EACH	£17.50

Swatch Battery Cover Key, Ladies

- Horotec Swiss MSA03.620LADY
- Ladies
- Ø10mm



Code	Description	UOM	Price
P38798	Swatch Battery Cover Key, Ladies	EACH	£17.50

Swatch Battery Cover Key Medium

- Horotec Swiss 03.620MED
- Medium
- Ø12mm



Code	Description	UOM	Price
P38799A	Swatch Battery Cover Key Medium	EACH	£17.50

Tube Key, Ø1.50mm

- Horotec Swiss MSA03.620.01



Code	Description	UOM	Price
P38783	Tube Key, Ø1.50mm	EACH	£14.95

Ø1.80mm Tube Key

- Horotec Swiss MSA03.620.02



Code	Description	UOM	Price
P38784	Ø1.80mm Tube Key	EACH	£14.95

Tube Key, Ø2.65mm

- Horotec Swiss MSA03.620.03



Code	Description	UOM	Price
P38785	Tube Key, Ø2.65mm	EACH	£14.95



Tube Key, Ø2.75mm

- Horotec Swiss MSA03.620.04



Code	Description	UOM	Price
P38786	Tube Key, Ø2.75mm	EACH	£14.95

Tube Key, Ø2.95mm

- Horotec Swiss MSA03.620.05



Code	Description	UOM	Price
P38787	Tube Key, Ø2.95mm	EACH	£14.95

Tube Key, Ø3.00mm

- Horotec Swiss MSA03.620.06



Code	Description	UOM	Price
P38788	Tube Key, Ø3.00mm	EACH	£14.95

Tube Key, Ø3.00mm - Inverted

- Horotec Swiss MSA03.620.07



Code	Description	UOM	Price
P38789	Tube Key, Ø3.00mm - Inverted	EACH	£14.95

Tube Key, Omega Seamaster

- 8 sided key for crown tube
- For Omega seamaster tubes
- Based on Omega tool 5100356
- Case Number 177.0519
- Necessary for the re-fitting of the threaded pendant tubes

A specific tube key is required



for its proper return without damage to the working surfaces.

Code	Description	UOM	Price
P47513	Tube Key, Omega Seamaster	EACH	£14.25

Pendant Tube Fitting & Removing

Pendant Tube Fitting & Removing Tools

- For tubes with an internal spline
- Various external diameters
- Swiss Made & Other

Multi Collet (internal) Spline Tool

VALUE



Tool with Aluminium Handle & Multiple Collets

- 4 Changeable Collets
- Smooth Ø3.00 to Ø3.25mm Tapered
- Smooth Ø2.70 to Ø2.90mm Tapered
- Spline Ø3.00mm Flute
- Spline Ø2.60mm Flute

Dimensions:

- Overall Length 110mm
- Handle Ø14mm

Weight 70g

Code	Description	UOM	Price
R33485	Multi Collet (internal) Spline Tool	EACH	£9.95

Ø1.60mm (internal) Spline Tool

Horotec 03.665.01 - Swiss Made

- For tubes with an internal spline
- Rolex Generic pendant tube fitting and removing tool
- For screwdown crown pendant tubes with an internal spline Ø1.60mm
- Also suitable for Rolex generic tube C8359 ("Twin Lock" Ø5.3mm, 24.5300.0)
- Swiss made



Code	Description	UOM	Price
R8718	Ø1.60mm (internal) Spline Tool	EACH	£21.25

Ø1.80mm (internal) Spline Tool

Horotec 03.665.02 - Swiss Made

- For tubes with an internal spline
- Rolex Generic pendant tube fitting and removing tool
- For screwdown crown pendant tubes with an internal spline Ø1.80mm
- Also suitable for Rolex generic tube C8360 ("Twin Lock" Ø6.0mm, 24.6000.0) and C8371 (old style oyster 3.00mm)



- Swiss made

Code	Description	UOM	Price
R8719	Ø1.80mm (internal) Spline Tool	EACH	£21.25

Ø2.70mm (internal) Spline Tool

COUSINSUK



- For tubes with an internal spline
- For screwdown crown pendant tubes with an internal spline Ø2.70mm
- Also suitable for Rolex generic tube C8367 (Ladies Oyster 24.5330.0) and C8368 (Ladies Oyster 24.5320.0)

Code	Description	UOM	Price
R12163	Ø2.70mm (internal) Spline Tool	EACH	£13.50

Ø2.70mm (internal) Spline Tool

Horotec 03.665.04 - Swiss Made

- For tubes with an internal spline
- For screwdown crown pendant tubes with an internal Spline Ø2.70mm
- Also suitable for Rolex Generic Tube C8367 (Ladies Oyster 24.5330.0) and C8368 (Ladies Oyster 24.5320.0)



Code	Description	UOM	Price
R19251	Ø2.70mm (internal) Spline Tool	EACH	£21.95

Ø3.00mm (internal) Spline Tool

Horotec 03.665.06 - Swiss Made

- For tubes with an internal spline
- For screwdown crown pendant tubes with an internal spline Ø3.00mm
- Also suitable for Rolex Generic Tube C8363 (Daytona 24.7030.0) and C8370 (Gents Oyster 24.6020.0)
- Swiss made

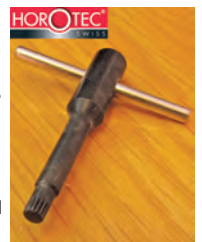

Code	Description	UOM	Price
R19252	Ø3.00mm (internal) Spline Tool	EACH	£21.95

Ø3.00mm (internal) Spline Tool

COUSINSUK



- For tubes with an internal spline
- For screwdown crown pendant tubes with an internal spline Ø3.00mm
- Also suitable for Rolex Generic Tube C8363 (Daytona 24.7030.0) and C8370 (Gents Oyster 24.6020.0)

Code	Description	UOM	Price
R19259	Ø3.00mm (internal) Spline Tool	EACH	£13.50



Ø3.00 & Ø3.20mm (internal) Spline Tool, Heavy Duty



- For tubes with an internal spline
- Specifically designed for Rolex case tubes Ø5.30 & Ø6.00mm
- Supplied with 2 size blades (reversible)
- Extra thick square handle
- Overall length 92mm
- Made in Korea

Code	Description	UOM	Price
T55417	Ø3.00 & Ø3.20mm (internal) Spline Tool, Heavy Duty	EACH	£34.95

Chronograph Pusher Tube Fitting & Removing

Chronograph Pusher Tube Fitting & Removing Tools

- For tubes with an external spline
- Various external diameters
- Swiss Made
- High Quality

Ø3.05mm (Internal) Spline Tool

Horotec 03.655 - Swiss Made



- For Screw In Chronograph Pusher Tubes
- For case tubes with an external spline
- Swiss Made

Code	Description	UOM	Price
P19253	Ø3.05mm (Internal) Spline Tool	EACH	£21.50

Ø3.33mm (Internal) Spline Tool



- Bergeon 5901-P03
- For Screw In Chronograph Pusher Tubes
- For case tubes with an external spline
- Swiss Made
- Blue Handle

Code	Description	UOM	Price
P1431	Ø3.33mm (Internal) Spline Tool	EACH	£43.95

Ø3.65mm (Internal) Spline Tool



- Bergeon 5901-P27
- For Screw In Chronograph Pusher Tubes
- For case tubes with an external spline
- Swiss Made
- Red Handle

Code	Description	UOM	Price
P1432	Ø3.65mm (Internal) Spline Tool	EACH	£43.95

Ø4.10mm (Internal) Spline Tool



- Bergeon 5901-P39
- For Screw In Chronograph Pusher Tubes
- For case tubes with an external spline
- Swiss Made
- Yellow Handle

Code	Description	UOM	Price
P1433	Ø4.10mm (Internal) Spline Tool	EACH	£63.95

Pusher and Corrector Fitting Pliers



Pliers for fitting friction fitted watch pushers and correctors to watch cases. Cast aluminium frame with two adjustable pressure probes and slotted lower jaw Arms stop device to avoid over pressure.

- Bergeon 6161
- Length 145mm

Code	Description	UOM	Price
P1429	Pusher and Corrector Fitting Plier, Bergeon	EACH	£86.95

Pusher and Corrector Removing Plier



Pliers for removing friction fitted watch pushers and correctors to watch cases. Cast aluminium frame with three punches and centre arm stop device.

- Bergeon 6160
- Length 145mm

Code	Description	UOM	Price
P1430	Pusher and Corrector Removing Plier, Bergeon	EACH	£102.95
P7629	Ø5mm Spare Punch	EACH	£5.75
P7630	Ø8mm Spare Punch	EACH	£5.75
P7631	Ø12mm Spare Punch	EACH	£5.75

Pusher & Pendant Tube Fitting & Removing Press

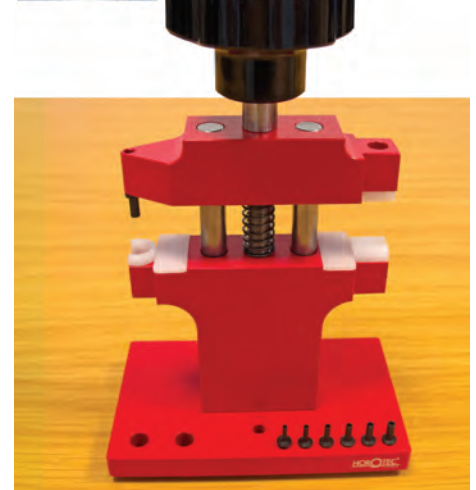

Horotec 03.657 - Swiss Made

- Press for fitting and removing pushers and pendant tubes with ease
- Minimizes the risk of damage to the pusher or tube
- Supplied 7 stakes
- 4 ridged rubber feet for extra stability
- Swiss made

Stake sizes (outside diameter x inside diameter):

- Ø1.55 x 1.05, 1.75 x 1.25, 1.95 x 1.45, 2.15 x 1.55, 2.45 x 1.55, 2.65 x 1.55 & 2.95 x 1.55mm

Code	Description	UOM	Price
P45772	Pusher & Tube Fitting & Removing Tool	EACH	£123.95
S49239	Ø1.55mm (Ø1.05mm) Stake	EACH	£5.95
S49240	Ø1.75mm (Ø1.25mm) Stake	EACH	£5.95
S49241	Ø1.95mm (Ø1.45mm) Stake	EACH	£5.95
S49242	Ø2.15mm (Ø1.55mm) Stake	EACH	£5.95
S49243	Ø2.45mm (Ø1.55mm) Stake	EACH	£5.95
S49244	Ø2.65mm (Ø1.55mm) Stake	EACH	£5.95
S49245	Ø2.95mm (Ø1.55mm) Stake	EACH	£5.95
S49709	Removing Delrin Support	EACH	£10.75
S49710	Fitting Delrin Support (Lower)	EACH	£8.55
S49711	Fitting Delrin Support (Upper)	EACH	£8.55

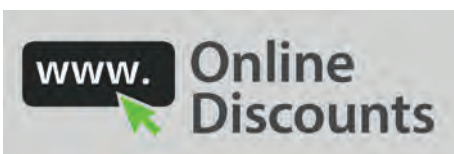

Sleeve Wrench for Pocketwatches



- Pocketwatch sleeve wrench
- 10 different styles of wrench will cover all pocket watch sleeve styles
- Stainless steel wrenches with brass centre
- Bergeon 3023.10

Code	Description	UOM	Price
P56437	Pocket Watch Sleeve Wrench	EACH	£29.95

Power Supplies



Mains Adaptor (230v)

For the following Elma equipment

- Watchmatic
- Watchmaster
- Profi Check
- Profi Check Rate

For the following Witschi equipment:

- Analyzer Twin
- Analyzer Q1
- Chronoscope S1
- Micromat C
- Micromat S
- Tech Handy 2
- Proofmaster M
- Proofmaster S
- Watch Expert 2, 3 & 4

Code	Description	UOM	Price
M32301	Mains Adaptor, Witschi 95.64.10	EACH	£28.95

BATTERY TESTING

Battery Tester Tweezers

VALUE



Battery Tester - Tweezers

- Simple, easy operation
- Compact tool
- Inexpensive to replace if lost or damaged
- Tests 1.5 volt & 3 volt batteries
- Light glow LED for 1.5V, bright glow for 3V
- Can be used for all kinds of 1.5 to 3 volt batteries

Code	Description	UOM	Price
T47702	Battery Testing Tweezers	EACH	£2.15

Etic Battery Tester



Battery Tester - Etic

- Etic Swiss
- "Improved"
- Red button simulates battery test under load

Tests:

- High drain
- Low drain
- Silver-mercury
- Lithium
- 1.35 to 1.5v & 3v

Code	Description	UOM	Price
T1685	Battery Tester, ETIC 340-450	EACH	£29.85

Non Branded Battery Tester

VALUE



Battery Tester - Non Branded

WATCH TESTING, TIMING, ROTATION & PRINTING

ADAPTERS & POWER ADAPTERS

Adaptor Plug (Euro to UK)



For Testing & Timing Equipment - Adaptor Plug - Euro to UK

Code	Description	UOM	Price
A32444	2 Pin to UK 3 Pin Plug Universal Adapter	EACH	£2.95
A33069	2 Pin to UK 3 Pin Plug Universal Adapter	EACH	£2.25
A48974	2 Pin to UK 3 Pin Plug Universal Adapter, Fused	EACH	£2.50
A40932	2 Pin to UK 3 Pin Plug Universal Adapter, Fused & Earthed	EACH	£3.25

Voltage Converter

Made in UK



Voltage Converter

- Voltage converter
- Designed to run 220/240 volt machines on 110 volt mains
- Can be used with any of our 220 to 240 volt machines (Elma, Witschi, Kronoglass, Bergeon etc.)
- Has a USA type 3 pin safety plug for the mains
- Has a UK type 3 pin plug socket for plugging in the equipment
- CE marked
- RoHS compliant
- Made in UK

Code	Description	UOM	Price
A52044	240 to 110 Voltage Adapter	EACH	£79.95

WORLDWIDE DELIVERY

SECURE ONLINE ORDERING

- 3 testing methods (pressure slot, current sensitive terminal posts or remote flexible probe tips)
- Self powering and offering 9 voltage test modes from 1.3/1.5v button cells through 8 more switchable voltages rising to max 22.5v
- Dimensions only 100 x 60 x 35mm, complete with instructions

Code	Description	UOM	Price
T9822	Mini Watch Battery Tester	EACH	£11.50

Renata Battery Tester (includes Mechanical Defect Test)



Watch Battery & Mechanical Defect Tester - Renata

This practical tester helps you to test before opening the watch case, whether a stopped analogue quartz watch actually requires a battery change or if it is a mechanical defect that may be blocking the stepping motor, in which case, a repair rather than a battery change is indicated.

If the watch hands are not moving, place the complete watch on the centre position to hear the pulse of the watch.

Plus complete testing of batteries.

- Renata Swiss

Code	Description	UOM	Price
T1684	Renata Watch & Battery Tester	EACH	£37.95

Kinetic Watch Charger



WIT Swiss

- Quick charging apparatus for watches that use capacitors
- Suitable for watch movements manufactured by Citizen, Miyota, Seiko, Swatch Group & others
- Indispensable after prolonged inoperation, infrequent wearing, service and testing purposes
- Only to be used for standard 1.5v capacitors
- 110/220 volt
- Requires adapter A48974
- Made in Europe

Instructions:

- Remove the drained capacitor from the watch (or use a new unused capacitor)
- Once plugged in, press down the alligator clip to light up the indicator LED. This demonstrates what the LED should look like once the capacitor is fully charged
- Place the capacitor under the alligator clip, with the positive side facing up
- If the LED lights up with bright intensity, the capacitor is fully charged
- If the LED lights up with medium intensity, the capacitor is partly charged
- If the LED lights up with low intensity, the capacitor is not charged
- Leave the capacitor under the alligator clip to start charging
- When charging begins, the LED will light up with bright intensity when the capacitor is fully charged

Charging times:

- From empty: 60 to 120 minutes
- From partially charged: 30 to 60 minutes

Dimensions:

- 115 x 85 x 65mm (Length x width x height)

Code	Description	UOM	Price
T48545	Capacitor Charger	EACH	£64.95

MECHANICAL & QUARTZ WATCH TESTING



Greiner:

- Greiner Chrono Touch: Simple & easy to use with a high quality, high resolution touch screen, supplied with a new generation microphone on a ball bearing making testing at all angles possible
- Greiner Compact 900: This is an all in one device, capable of performing all the measurements and tests associated with & required for quartz & mechanical watches. The best Switzerland has to offer!

TYMC:

- MTG-4000A: Accurate to 1 second per day with a quality LCD touch screen and supplied with a microphone that has 6 different testing positions
- MTG-5000A: Accurate to 0.2 seconds per day with a quality LCD touch screen and supplied with a microphone that has 6 different testing positions
- MTG-9900A: A complete system with tester, printer & automatic microphone, accurate to 1 second per day

Witschi:

- Witschi insist that UK distributors are only authorised to sell Witschi products to the UK & Eire, for overseas customers we can offer the Greiner & TYMC alternatives.
- Witschi Analyzer Twin: This measurement

and testing instrument includes all the tests associated with quartz watches as well as all the tests required for mechanical watches, combined in one machine.

- Witschi Watch Expert: 2 display modes, high quality touch screen display, new generation interactive microphone and the ability to see the results of all 6 testing positions in one screen
- Witschi Chronoscope S1 (G2): 3 display modes, high quality touchscreen display and available with either a manual or automatic microphone (with 7 testing positions).
- Witschi Chronoscope X1 (G3): 6 display modes, high quality, super high contrast touch screen and supplied with an automatic microphone with 10 pre programmed positions.
- Witschi Chronomaster: The same testing specification as the watch expert, conducting & then displaying the results of professional mechanical watch tests on your existing PC or tablet screen
- Witschi Chronomaster Pro: The same testing specification as the chronoscope S1, conducting & then displaying the results of professional mechanical watch tests on your existing PC or tablet screen
- Witschi Micromat C: The same testing specification as the Chronoscope X1, conducting & then displaying the results of professional mechanical watch tests on your existing PC or tablet screen
- Witschi Chronocube: Elegant and sleek, designed to sit on a retail counter and demonstrate live to your customer the accuracy of the watch. 5 available testing positions

Please see each product for detailed item descriptions & specifications, manufacturer instructions & high definition images

Greiner Chrono Touch



For Mechanical Movements

The Chrono Touch belongs to the latest generation of watch testers.

The Greiner Chrono Touch watch tester is simple to operate via a touchscreen and a crystal-clear, high-resolution color display.

Key features

- Automatic detection of beat number, rate, amplitude and beat error
- Manual configuration of beat number also possible
- Measurement time and lift angle can be freely selected
- Graphic display of beat noise of watch (oscillogram)
- Loudspeaker for listening to watch noise
- Crystal-clear, high-resolution display with touchscreen operation
- Simple operation via touchscreen with useful menus
- Special programme for Co-Axial-escapement
- Special programme for pendulum clocks
- USB interface for software updates
- Ethernet interface for network connection
- Microphone for mechanical watches included (Greiner MP12, our code G55025)

- Checking at all angles is possible due to ball-bearing fitting of the microphone
- 220/110 volt
- See "document" link above for full instruction manual

Code	Description	UOM	Price
G55028	Greiner Chrono Touch	EACH	£1,495.00

Greiner Compact 900



Greiner - Compact 900 - For Mechanical & Quartz Movements

This is an all in one device, capable of performing all the measurements and tests associated with & required for quartz & mechanical watches.

For mechanical movements:

- Beat number (automatic), beat error, time deviation, amplitude, escapement noise (graphic). Special program for the quick check of pendulum clocks and special program for special escapements.

For quartz movements:

- Time deviation (with/without Inhibition), no load consumption, average consumption, impulse consumption, resistance of motor coil, battery voltage (High Drain/Low Drain), lower working-voltage limit and EOL.

Microphones:

- The compact 900 is delivered without a microphone, allowing you to pick which microphone you want
- Microphone for testing mechanical watches: Our code G55025
- Microphone for testing mechanical & quartz watches: Our code G55026
- Automatic microphone for testing mechanical watches: Our code G55024

Features:

- Full colour, 12 x 9cm display
- 8 buttons for easily and quick handling of different functions
- Automatic standby when not in use
- Special programme for Co-Axial-escapement
- Special programme for pendulum clocks
- The results can be printed or transferred to your computer
- LED indicator signalling the machine is receiving a signal from the movement
- 220/110 volt
- See PDF download above for full instruction manual

Code	Description	UOM	Price
G55023	Greiner Compact 900	EACH	£2,495.00
G55024	Automatic Microphone, Greiner AM10	EACH	£1,495.00
G55025	Microphone for Mechanical Movements, Greiner MP12	EACH	£395.00
G55026	Microphone for Mechanical & Quartz Movements, Greiner QM06	EACH	£649.00
G55027	Power Supply Support, Greiner EM 06	EACH	£149.95

TYMC MTG-4000A



For Mechanical Movements

- Accurate to +/- 1 second per day
- 7 inch LCD touch screen
- 480 dot display
- Pre programmable testing
- Microphone included

Manufactured by TYMC corporation in Beijing, this tester provides the watch repairer simple access to the measurement of a watch's rate, amplitude and beat error in 2 different display modes & in 6 possible positions.

- New watch timing & testing equipment
- Improved measurement performance
- Numerical values of the rate, beat error and amplitude are all displayed at the same time
- 7" inch large colour LCD screen
- Calendar / time display function
- High precision printing function
- Digital sound representation is at the same frequency of the watch movement
- For professional service centres and individual workshops
- 240 or 110 volt available

Specification:

- Beat number: The most popular eat numbers are pre programmed (18000, 19800, 21600, 25200, 28800 & 36000)
- Beat error measurement range: 4.0ms
- Rate precision: +/- 1.0 s/d
- Rate range: +/- 300s/d
- Amplitude range: 100 ° to 345 ° (display possible to 999 °)
- 480 dot diagram display
- See PDF for full specifications

Code	Description	UOM	Price
T33493	MTG-4000A Mechanical Watch Timing Machine, 240V	EACH	£675.00
T34254	MTG-4000A Mechanical Watch Timing Machine, 110V	EACH	£660.00
T34403	MTG-PM Thermo-Direct Printer, 240V	EACH	£210.00
T34404	MTG-PP Thermo-Direct Printer Paper	EACH	£2.15

TODAY SAME DAY DISPATCH

www. Online Discounts

PRICE PROMISE GUARANTEE

TYMC MTG-5000A

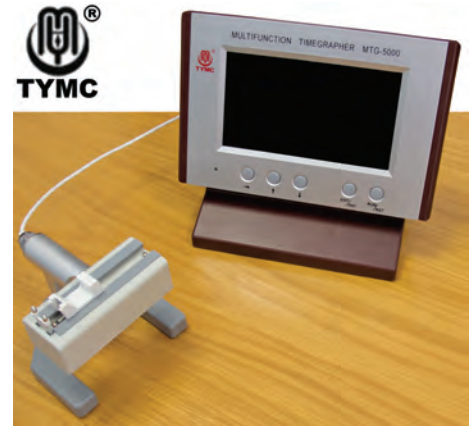

For Mechanical Movements

- Accurate to +/- 0.2 seconds per day
- 7 inch LCD colour screen
- 480 or 960 dot display
- Pre programmable testing
- Microphone included

The MTG-5000 is used to test the performances of mechanical watches, and is the most advanced model in the MTG series with a higher test accuracy and more powerful functionality.

Manufactured by TYMC

- New watch timing & testing equipment
- Improved measurement performance, accurate to 0.2 seconds per day
- 5 testing modes
- 960 dot display giving an extraordinarily long diagram of beat
- Numerical values for rate, amplitude and beat error all displayed
- Pause & shift function, allowing in testing review
- Long term (32 hour) monitoring mode
- Built in power pack
- 7" inch large colour LCD screen
- Two window display testing
- Calendar / time display function
- High precision printing function
- Digital sound representation is at the same frequency of the watch movement
- For professional service centres and individual workshops
- Printer: Cousins ref T34403
- Power range 100 to 240 volt (can be used either at 240 volt or 115 volt)

Technical Specification:

- Rate: -99.9 s/d - +99.9 s/d (Accuracy = +/-0.2 seconds per day)
- Amplitude: 100 ° - 345 ° (Accuracy : +/-3 °)
- Beat error: 0 - 4.0 ms (Accuracy : +/-0.1ms)
- Beat (Trains): 18000, 19800, 21600, 25200, 28800, 36000
- Length of diagram either 480 or 960 dots
- Microphone has 6 testing positions
- Horizontal or vertical display
- 220 to 240 Volt (230 to 110 volt converter please see our code A52044)
- Weight 1.4kg
- Dimension: 250mm x 200mm x 130mm
- Extensive PDF operators manual

Code	Description	UOM	Price
T39016	MTG-5000A Mechanical Watch Timing Machine, 240V	EACH	£850.00

TRADE SUPPLIER

ORDER tracking

TYMC MTG-9900A



For Mechanical Movements

- Accurate to +/- 1 second per day
- 7 inch LCD colour touch screen
- Up to 1600 dot display
- Pre programmable testing
- Automatic microphone included

The latest and greatest in breakthrough TYMC technology

Kit includes:

- Timegrapher MTG9900A, with touch screen
- Automatic microphone
- Automatic heat sensitive printer

Tester specifications:

- New touch screen, high definition LCD colour display
- Increased number of testable beats: 1200, 14400, 18000, 19800, 21600, 25200, 28800 & 36000 (can be selected automatically or manually)
- Accuracy: + / - 1 second per day
- Amplitude measurement: 90 to 350 degrees (+ / - 3 degrees)
- Beat error measurement: 0 to 4ms (+ / - 0.1ms)
- Up to 1600 dot display, giving you maximum testing and accuracy results
- Can test co-axial watches
- Digital sound representation is at the same frequency of the watch movement
- 190 x 190 x 135mm (H x W x D)
- 150 x 70mm LCD touch screen
- Replacement printer paper see code T34404
- Power range 100 to 240 volt (can be used either at 240 volt or 115 volt)

Automatic microphone specifications:

- 3 speeds
- 6 positions
- Will rotate automatically or can be changed by hand
- 140 x 120 x 200mm (H x W x D)

See documents and video links for further information and demonstration

Code	Description	UOM	Price
T45599	MTG 9900A Testing System	EACH	£995.00

Witschi Analyzer Twin



Witschi - Analyzer Twin - Microphone Included - For Mechanical & Quartz Movements

A combined tester for both quartz and mechanical watches

This measurement and testing instrument includes all the tests associated with quartz watches as well as all the tests required for mechanical watches, combined in one machine.

It is the ideal test instrument for the repair service, the lab or watch sale outlets. Basic functions and measurement sequences, largely automated, provide a fast and efficient operation. Additional measurement modes provide a way to measure watches with special escapements.

- Witschi insist that UK distributors are only authorised to sell Witschi products to the UK & Eire, for overseas customers we can offer the Greiner & TYMC alternatives.

Quartz specification:

- Rate precision: +/- 0.1s/d
- Rate range: +/- 300s/d
- Rate resolution: 0.1s/d
- Vibration range: From 12600 to 43200
- Measurement time: 2s to 960s

Mechanical specification:

- Rate: +/-0.1 second per day
- Amplitude: +/- 0.4 °
- Beat error: +/- 0.1ms
- Rate range: +/- 300s/d
- Amplitude range: 80 ° to 360 °
- Beat error range: 0 to 9.9ms

Features:

- The "all-in-one" concept requires a very small work area
- High operating comfort, functional control panel with large LCD screen
- Measurement over the quartz frequency, signal sensing acoustical, capacitive or over the supply current
- Measurement over the motor pulses, magnetically signal sensing or over the supply voltage
- Measurement over the LCD-operating frequency (binary display frequencies)
- Includes contact probes and wires
- Include microphone
- Language can be set in English, French or German
- Measurement parameters can also be manually selected according to requirements. The main menu, results, parameters, submenus and information are presented on a colour display
- 220 to 240 Volt (230 to 110 volt converter please see our code A52044)

Also available:

- Printer = Product Code P15224 or P38415
- Microphone = Product Code T12040
- Replacement power adapter = Product Code M32301

Officially Appointed Witschi Distributor

Click website "More Information" & "PDF's" for full specification.

For service, calibration & repairs of items inside and outside of the warranty period please submit a quote request via our online support under products & stock - product advice and repairs – Witschi equipment calibration

Code	Description	UOM	Price
W34907	Witschi Analyzer Twin	EACH	£5,495.00



Witschi Calibration GPS Receiver



Witschi - GPS Calibration Receiver

Calibrate your witschi devices in your own workshop, without the need to return your device to Witschi, with the Witschi GPS calibration receiver.

Using the GPS Receiver, you can calibrate the time base of our watch testing and measuring devices. The atomic clock time signals transmitted by GPS-S satellites are stored in the GPS receiver for 5 to 12 seconds. The average value of all signals received provides an extremely stable time signal with which watch testing and measuring devices can be calibrated and harmonised. The time signals from 4 to 5 GPS satellites are necessary for a reliable result. Accuracy is to 1 PPS (pulses per second) +/-15 to 75 ns (nanoseconds).

Following Witschi equipment can be calibrated:

- Watch Expert II
- Watch Expert III
- The Watch Expert
- Chronoscope S1
- Chronoscope S1 (G2)
- WisioScope S
- Micromat C 1
- Chronoscope M1
- Chronoscope M10
- Chronoscope PC20
- New Tech Handy II
- Analyzer Twin
- Analyzer Q1
- Analyzer Q2
- Witschi insist that UK distributors are only authorised to sell Witschi products to the UK & Eire, for overseas customers we can offer the Greiner & TYMC alternatives.

Code	Description	UOM	Price
W55829	GPS Calibration Kit	EACH	£1,595.00

Witschi Chronocube



Witschi - Chronocube - For Mechanical Movements

Insert watch, contact sensor, job done. The Witschi Chronocube is designed to offer fast testing results that are easy to read & display in a retail environment (or workshop). This device enables you to easily and clearly demonstrate the accuracy of a mechanical watch (brand new, repaired or serviced) to your customer ensuring customer satisfaction everytime as well as driving sales. The results can be displayed on your existing PC or tablet screen, either in a classic test display mode or the new "sport" user friendly interface.

- Witschi insist that UK distributors are only authorised

to sell Witschi products to the UK & Eire, for overseas customers we can offer the Greiner & TYMC alternatives.

- Simple testing system that can be used in workshop or retail environment
- Compact, sleek & elegant design
- You have a choice of three colours and either "CLASSIC" or "SPORT" results display
- Connects to your computer via USB interface
- Install the Witschi software on your PC, plug in the Chronocube and you are ready

Features:

- Measures rate variation, amplitude and beat error in mechanical watches
- 5 measuring positions manually selectable (the measuring position is detected automatically and displayed on your computer screen)
- Automatic beat detection between 12,000 and 72,000
- The Chronocube consists of a measuring device and software, no parametrisation is necessary
- Choice of user interfaces: You have a choice of two user interfaces, "classic" and "sport"
- Three colours: The Chronocube is available in aluminium, steel and ruby
- Language selection: English, French, German, Spanish or Italian

Specification:

- Rate precision: +/- 0.1s/d (range +/- 999s/d)
- Amplitude precision: +/- 0.4 ° (range 80 ° to 360 °)
- Beat error precision: +/- 0.1ms (range 0 to 9.9ms)
- Vibration range: 12,000 to 72,000
- Lift angle: 10 ° to 90 ° (1 ° jumps)
- Stabilization time: 20 seconds
- Measure time: 1 hour maximum
- Measuring positions: 5
- 110 x 110 x 115mm (width x height x depth)
- 220 to 240 Volt (230 to 110 volt converter please see our code A52044)

Click website "More Information" & "PDF's" for full specification.

For service, calibration & repairs of items inside and outside of the warranty period please submit a quote request via our online support under products & stock - product advice and repairs - Witschi equipment calibration

Code	Description	UOM	Price
W36034	Aluminium Chronocube	EACH	£1,215.00
W36032	Red Chronocube	EACH	£1,215.00
W36033	Steel Chronocube	EACH	£1,215.00

Witschi ChronoMaster



Witschi - ChronoMaster - For Mechanical Movements

Measuring rate variation, amplitude and beat errors in mechanical watches with 2 different display modes.

The Witschi ChronoMaster system is a stand alone testing system (a manual microphone with built in testing software) that offers the same testing specification as the watch expert, conducting & then displaying the results of professional mechanical watch tests on your existing PC or tablet screen.

- Witschi insist that UK distributors are only authorised to sell Witschi products to the UK & Eire, for

overseas customers we can offer the Greiner & TYMC alternatives.

- Manual microphone with built in watch expert intelligence
- Shows your test results on your own computer or tablet
- No separate display screen, saving valuable space
- Connects to your computer via USB interface
- 4 programmable microphone buttons allows you to control the software
- Install the Witschi software on your PC, plug in the ChronoMaster and you have your own Witschi Watch Expert

2 different measurement methods are available to you for the quality control of mechanical watches with or without a strap. Rate accuracy, amplitude & beat error are all displayed numerically. The ChronoMaster Pro with its display on your PC works with operating systems; Windows 7, Windows 8.1 or Windows 10.

- Display modes: Continuous diagram recording & vario display mode
- Automatic detection of 6 main positions, 4 vertical positions and 2 special positions
- Guided sequence mode, adjustable 1 to 10 testing positions
- Accurate positioning every 45 °
- Convenient operation of "Chronoscope Service" display software, thanks to built-in control buttons
- Automatic selection of all common beat numbers
- Manual selection of any beat number between 3600 to 72,000
- Continuous diagram recording: selectable integration time 2 to 240s and adjustable zoom x1 to x16
- Secure mount, even for large watches
- Works with your existing PC with windows on a computer or tablet
- Works with operating systems: Windows 7, Windows 8.1 or Windows 10
- Can work with the Omega co-axial escapement

Specification:

- Beat error measurement range: 9.9ms
- Rate precision: +/- 0.1s/d
- Rate range: +/- 999.9s/d
- Amplitude range: 70 ° to 360 ° (display possible to 999 °)
- Rate resolution: 0.1sd

Code	Description	UOM	Price
W53342	ChronoMaster	EACH	£1,595.00

Witschi ChronoMaster Pro



Witschi - ChronoMaster Pro - For Mechanical Movements

The Witschi ChronoMaster Pro system is a stand alone testing system (a manual microphone with built in testing software) that offers the same testing specification as the Chronoscope S1, conducting & then displaying the results of professional mechanical watch tests on your existing PC or tablet screen.

- Witschi insist that UK distributors are only authorised to sell Witschi products to the UK & Eire, for overseas customers we can offer the Greiner & TYMC alternatives.
- Manual microphone with built in Chronoscope S1 intelligence

- Shows your test results on your own computer or tablet
- No separate display screen, saving valuable space
- Connects to your computer via USB interface
- 4 programmable microphone buttons allows you to control the software
- Install the Witschi software on your PC, plug in the ChronoMaster Pro and you have your own Chronoscope S1 (with manual microphone)

6 different measurement methods are available to you for the quality control of mechanical watches with or without a strap. Rate accuracy, amplitude & beat error are all displayed numerically. The ChronoMaster Pro with its display on your PC works with operating systems; Windows 7, Windows 8.1 or Windows 10.

- Display modes: Continuous diagram recording, vario display, trace display, sequence display, polar display & scope display
- Measures the rate accuracy, amplitude & beat error
- Automatic detection of 6 main positions, 4 vertical positions and 2 special positions
- Guided sequence mode, adjustable 1 to 10 testing positions
- Accurate positioning every 45 °
- Automatic beat selection of all common beat numbers
- Manual selection of any beat number between 3600 to 72,000
- Continuous diagram recording: selectable integration time 2 to 240s and adjustable zoom x1 to x16
- Secure mount, even for large watches
- Works with your existing PC with windows on a computer or tablet
- Works with operating systems: Windows 7, Windows 8.1 or Windows 10
- Can work with the Omega co-axial escapement

Specification:

- Rate precision: +/- 0.1s/d (range +/- 999s/d)
- Amplitude precision: +/- 1.0 ° (range 70 ° to 360 °)
- Beat error precision: +/- 0.1ms (range 0 to 9.9ms)
- Lift angle: 10 ° to 90 ° (0.1 ° jumps)
- Stabilization time: 2 seconds to 60 minutes
- Measure time: 2 seconds to 100 hours
- Measuring positions: 10

Officially Appointed Witschi Distributor

Click website "More Information" & "PDF's" for full specification.

For service, calibration & repairs of items inside and outside of the warranty period please submit a quote request via our online support under products & stock - product advice and repairs - Witschi equipment calibration

Code	Description	UOM	Price
W52038	ChronoMaster Pro	EACH	£1,995.00

Witschi Chronoscope S1 (G2)



Witschi - Chronoscope S1 (G2) - Generation 2 - With or without microphone - For Mechanical Movements

- Either supplied with standard microphone (T12040) or on its own
- Generation 2 Chronoscope S1 with capacitive touch screen
- Power range 100 to 240 volt (can be used either at 240 volt or 115 volt)
- Witschi insist that UK distributors are only authorised to sell Witschi products to the UK & Eire, for

overseas customers we can offer the Greiner & TYMC alternatives.

The chronoscope either comes with a standard microphone included or on its own. Also available is the automated microphone "Micromat S" (W34910) which offers seven different measurement cycles. The measurement results, the average values and the largest deviations are available in a table at the end of the measurement cycle. The new «VARIO» display mode provides a fast overview of the quality and stability of the rate accuracy. It is the ideal mode for the receiving inspection and the point of sales in a specialized watch shop.

Specification:

- Rate precision: +/- 0.1s/d (range +/- 999s/d)
- Amplitude precision: +/- 0.4 ° (range 80 ° to 360 °)
- Beat error precision: +/- 0.1ms (range 0 to 9.9ms)
- Vibration range: 3600 to 72000
- Lift angle: 10 ° to 90 °

Also available:

- Automatic microphone available (Witschi micromat S): W34910
- Printer available: P15224 or P38415
- Witschi auto print kit: W38268
- Replacement power adapter: M32301
- Can also test quartz movements with the microphone for quartz movements: W47896 (supplied separately)
- Bluetooth module to connect to Witschi printer wirelessly: B49303

Officially Appointed Witschi Distributor

Click website "More Information" & "PDF's" for full specification.

For service, calibration & repairs of items inside and outside of the warranty period please submit a quote request via our online support under products & stock - product advice and repairs – Witschi equipment calibration

Code	Description	UOM	Price
W37691	Chronoscope S1 (G2), with Microphone	EACH	£2,995.00
W39843	Chronoscope S1 (G2) without Microphone	EACH	£2,295.00
W34910	Automatic Microphone (Witschi Micromat S)	EACH	£1,895.00
W47896	Manual Microphone for Quartz Movements	EACH	£625.00

Witschi Chronoscope X1 (G3)



Witschi - Chronoscope X1 (G3) - Micromat C Microphone Included - Touch screen - For Mechanical Movements

The best Chronoscope X1 (G3) ever is a fantastically finished device made of first-class materials. A capacitive touch screen made of high-quality glass shows the measurement results on its brilliant, high-contrast display. The bright, full-colour touch screen has a high-grade aluminium surround and stands on an elegant base.

- Witschi insist that UK distributors are only authorised to sell Witschi products to the UK & Eire, for overseas customers we can offer the Greiner & TYMC alternatives.
- New improved hyper sensitive, 10.4 inch colour touch screen

- Touch screen is now as sensitive as your smart phone
- Faster firmware
- Super colour contrast
- Power range 100 to 240 volt (can be used either at 240 volt or 115 volt)

Included:

- Witschi Chronoscope X1, generation 3
- Witschi Micromat C, automatic microphone (Cousins ref: W34908)

Specification:

- Rate precision: +/- 0.1s/d (range +/- 999s/d)
- Amplitude precision: +/- 0.4 ° (range 80 ° to 360 °)
- Beat error precision: +/- 0.1ms (range 0 to 9.9ms)
- Vibration range: 3600 to 72,000 (& 360,000)
- Lift angle: 10 ° to 90 ° (0.1 ° jumps)
- Stabilization time: 2 seconds to 2 minutes
- Measure time: 4 seconds to 99 hours, 59 minutes & 58 seconds
- Measuring positions: 10

Particular features:

- 10.4 inch, hyper sensitive colour touch screen
- 6 display modes show measurements in a way adapted to the users needs (see PDF for full specification)
- Automatic selection of all common beat numbers, manual selection of any beat between 3600 & 72000 (and 360,000)
- Possible to create up to 99 stored measurement programmes
- Screen capture (camera function)
- Up to 99 pictures can be stored, presenting the test results via a slide show
- Display of PDF documents
- Continuous diagram recording
- Up to 10 test positions selectable
- Language selection: English, French, German, Spanish or Italian

Display modes (See PDF for full specification)

- Diagram display mode
- Vario display mode
- Sequence display mode
- Scope display mode
- Polar display mode
- Network compatible
- Customer and watch data

Also available:

- Martel thermo printers: P15224
- Witschi printer with auto cutter: P38415
- Witschi auto print kit: W38268
- Bluetooth module to connect to Witschi printer wirelessly: B49303

Officially Appointed Witschi Distributor

Click website "More Information" & "PDFs" for full specification.

For service, calibration & repairs of items inside and outside of the warranty period please submit a quote request via our online support under products & stock - product advice and repairs – Witschi equipment calibration

Code	Description	UOM	Price
T44313	Chronoscope X1 Generation 3	EACH	£5,795.00



Witschi Micromat C System



Witschi - Micromat C System - For Mechanical Movements

The Witschi Micromat C system is a stand alone testing system (an automatic microphone with built in testing software) that offers the same specification and testing ability of the Chronoscope X1, conducting & then displaying the results of professional mechanical watch tests on your existing PC or tablet screen.

- Witschi insist that UK distributors are only authorised to sell Witschi products to the UK & Eire, for overseas customers we can offer the Greiner & TYMC alternatives.
- Automatic microphone with built in Chronoscope X1 intelligence
- Shows your test results on your own computer or tablet
- No separate display screen, saving valuable space
- Connects to your computer via USB interface
- Install the Witschi software on your PC, plug in the Micromat C and you have your own Chronoscope X1

This instrument is characterised by its user-friendly design and small size. Included is the new Witschi feature, the computation and display of the balance wheel's centre of unbalance.

Four different measurement methods are available to you for the quality control of mechanical watches with or without a strap. The beat noise is displayed graphically and automatic test sequences with 2 to 10 different test positions are possible. The Micromat C Service testing system with its display on your PC works with operating system : Windows 7, Windows 8 or Windows 10.

- Measures the rate accuracy, amplitude & beat error
- Endless measurement, continuous diagram recording or graphic display of the beat noises
- Up to 10 testing positions manually selectable. 6 testing positions are possible for sequential (automatic) measurement
- Automatic beat selection of all common beat numbers
- Manual selection of any beat number between 3600 to 72,000 & 360,000
- Works with your existing PC with windows on a computer or tablet
- Works with operating systems: Windows 7, Windows 8 or Windows 10
- Can work with the Witschi Chronoscope X1 (any generation)
- Can work with the Omega co-axial escapment
- Language selection: English, French, German, Spanish or Italian
- Replacement power adapter: M32301
- 220 to 240 Volt (230 to 110 volt converter please see our code A52044)

Specification:

- Rate precision: +/- 0.1s/d (range +/- 999s/d)
- Amplitude precision: +/- 0.4 ° (range 80 ° to 360 °)
- Beat error precision: +/- 0.1ms (range 0 to 9.9ms)
- Vibration range: 3600 to 72,000 (& 360,000)
- Lift angle: 10 ° to 90 ° (0.1 ° jumps)
- Stabilization time: 2 seconds to 60 minutes
- Measure time: 2 seconds to 300 hours
- Measuring positions: 10

Officially Appointed Witschi Distributor

Click website "More Information" & "PDF's" for full specification.

For service, calibration & repairs of items inside and outside of the warranty period please submit a quote request via our online support under products & stock - product advice and repairs - Witschi equipment calibration

Code	Description	UOM	Price
W34908	Witschi Micromat C System	EACH	£4,995.00

Witschi Watch Expert (4th Generation)



For Mechanical Movements

New Features:

- High capacitive touch screen
- The results of the 6 main testing position are available in one glance
- New interactive microphone (included), control the machine from the microphone
- Witschi insist that UK distributors are only authorised to sell Witschi products to the UK & Eire, for overseas customers we can offer the Greiner & TYMC alternatives.

The WATCH EXPERT is the ideal measuring instrument for testing the rate accuracy, amplitude and beat error of mechanical watches in 2 different display modes. Apart from its precision measurements and multiple measurement modes, the latest watch expert offers unique convenience at work.

Now with a high-quality capacitive touchscreen, the display of your measurement results is brilliant, high-contrast and reflection-free. You can navigate the menus on the large colour display with four control buttons on the new microphone. The watch expert 4 offers watchmaking experts ergonomics, comfort and precision

- The most important results in one glance, the diagrams of all 6 main testing positions displayed in one screen (can also be displayed individually)
- Work comfortably & safely on a reflection-free display
- 7 inch capacitive touch screen works even whilst wearing cotton gloves
- Quick and easy to switch between test positions
- Integrated loudspeaker for acoustic display testing of beat
- New design interactive microphone (included)
- Automatic recognition of 11 testing positions
- Safe and secure mount, even for heavy & large watches
- Programmable buttons on the microphone allow you to control the testing and display on the watch expert 4
- Power range 100 to 240 volt (can be used either at 240 volt or 115 volt)

Specification:

- Beat number: 14 pre programmed beats or manual programming available (manual programming from 3600 to 86400)
- Beat error measurement range: 9.9ms
- Rate precision: +/- 0.1s/d
- Rate range: +/- 999.9s/d
- Amplitude range: 70 ° to 360 ° (display possible to 999 °)
- Rate resolution: 0.1sd
- See PDF for full specifications

Also available:

- Witschi printer with auto cutter = P38415
- Mains Adaptor = M32301 (one already included)
- Bluetooth module to connect to Witschi printer wirelessly: B49303

For service, calibration & repairs of items inside and outside of the warranty period please submit a quote request via our online support under products & stock - product advice and repairs - Witschi equipment calibration

Code	Description	UOM	Price
T46232	Witschi Watch Expert IV	EACH	£2,375.00

WeiShi 1000



For Mechanical Movements

New watch timing & testing equipment for mechanical watches

- 4" x 1 1/2 inch large LCD screen
- Line display length: 196 dots
- Will calculate the rate deviation, amplitude and beat error and display them in real time
- For professional service centres and individual workshops
- Microphone included
- Made in China

Technical Specification:

- Rate: -999 s/d - +999 s/d (Accuracy +/-1s/day)
- Amplitude: 100 ° - 360 ° (Accuracy : +/-1 °)
- Beat error: 0 - 9.9ms (Accuracy : +/-0.1ms)
- Beat (Trains): All common ones pre-programmed, others can be manually entered
- Microphone has 6 testing positions
- Mains 240v
- Weight 1.7kg
- Dimensions: 170mm x 110mm x 500mm
- 220 to 240 Volt (230 to 110 volt converter please see our code A52044)

Code	Description	UOM	Price
T38209	Watch Timing & Testing Machine	EACH	£169.95

WeiShi 1900



For Mechanical Movements

New watch timing & testing equipment for mechanical watches

- 4" x 1 1/2 inch large LCD screen
- Line display length: 480 dots
- Will calculate the rate deviation, amplitude and beat error and display them in real time
- For professional service centres and individual workshops
- Microphone included
- CE certified
- Made in China

Technical Specification:

- Rate: -999 s/d - +999 s/d (Accuracy +/-1s/day)
- Amplitude: 100 ° - 360 ° (Accuracy : +/-1 °)
- Beat error: 0 - 9.9ms (Accuracy : +/-0.1ms)
- Pre programmed beats (Trains): 12000, 14400, 18000, 19800, 21600, 25200, 28800, 36000, 43200
- Manual selection available for other beats
- Sampling periods selectable: 2, 4, 6, 8, 12, 20, 30 & 60 seconds
- Microphone has 6 testing positions
- Weight 1.7kg
- Dimensions: 240 x 190 x 210mm
- PDF operators manual
- 220 to 240 Volt (230 to 110 volt converter please see our code A52044)

Code	Description	UOM	Price
W47107	WeiShi 1900	EACH	£199.95

QUARTZ WATCH TESTING

Horotec Flashtest



New, updated & improved!

The new version, touch screen, all in one ergonomic device for complete testing of quartz watches & movements.

Functions:

- Test battery voltage from 0 to 19.99 volts
- Test battery voltage under load from 0 to 19.99 volts
- Measure the coil impulse to determine if the problem is electronic or mechanical
- Measure the continuity of the coil
- Test the consumption of the circuit to determine whether it needs replacing
- Test the consumption of the movement
- Fast gear train rotation to determine if the problem is a mechanical fault or if the train needs cleaning
- Measure the accuracy of the watch in seconds per day
- Mute or sound mode available
- See PDF above for full user manual

Specifications

- Colour touch screen 48 x 36mm
- Easy to read screen display, with 15mm high numerals
- Overall size 155 x 172 x 55mm
- Dual 220 & 110 volt
- Horotec Swiss
- Horotec 19.115

In the box:

- Horotec Flashtest
- 1 pair of probes
- 110/220 volt adapter
- Multi lingual operation manual

Code	Description	UOM	Price
T45617	Horotec FlashTest	EACH	£325.00

Horotec Pulse



Horotec Pulse is an electronic device for testing the electronic parts (coil/circuit) of quartz watch movements.

- Checks the pulse of the electronic components of quartz watches
- No need to open the case
- Horotec 19.106

Code	Description	UOM	Price
T52467	Horotec Pulse, Horotec 19.106	EACH	£52.95

Horotec Turbo



Horotec Turbo tests the mechanical parts (wheel train) of quartz watch movements. Use this tester as a complement to your traditional watch battery tester as it tests the inside workings of your quartz watch movement and helps you determine if replacing your watch battery will actually fix the problem or if there is another issue with the movement.

- Frees jammed trains by special electronic element, puts the second hand in motion
- Can tell the user if the issue is the battery or the gear train wheels, without opening the watch
- Operates with magnetic impulsion
- Jump starts train wheels
- Clears dust and debris from the train without having to open the watch case
- For best results you will want to let the Turbo Tester drive the train wheels for about two minutes
- Not for use with mechanical watches
- Horotec 19.107

Operation:

- Lay the watch out face up on the tester so you can watch the hands move
- You may have to adjust the watch's position on the

tester until the pulse is directed at the right point inside the movement

- You can only use this tester on electronic quartz movements, mechanical watches lack the parts to respond to the pulse
- If the hands do not move smoothly around the watch dial while on the tester, you will know there is another issue with the movement
- When you remove the watch from the tester, the hands should continue to work at normal speed if the battery is ok and the train wheels were the problem

Code	Description	UOM	Price
T52468	Horotec Turbo, Horotec 19.107	EACH	£49.95

Witschi Analyzer Q1 (with New VARIO Mode)



Witschi - Analyzer Q1 - (with New VARIO Mode)

The Analyzer Q1 is the ideal instrument for the efficient and fast testing in the repair workshop, in watch laboratories as well for final control before sale. Extensive testing and measuring features guarantee skilled trouble shooting on quartz watches. The measurement process is largely automated. The multifunctional rotating/push knob allows quick and easy parameter settings. The placement of the control panel and the large LCD screen ensure this machine is highly functional as well as comfortable to use. The chopping rate of the motor pulses on watches is easily detected and displayed

The new "VARIO" display mode (a Witschi Invention) allows the user to set the desired vibration rate and view the results on screen.

- Witschi insist that UK distributors are only authorised to sell Witschi products to the UK & Eire, for overseas customers we can offer the Greiner & TYMC alternatives.

Specification:

- Rate precision: +/- 0.1s/d
- Rate range: +/- 300s/d
- Rate resolution: 0.1sd
- Vibration range: From 12600 to 36000
- Measurement time: 2s to 960s

Features:

- The "all-in-one" concept requires a very small work area
- High operating comfort, functional control panel with large LCD screen
- Measurement over the quartz frequency, signal sensing acoustical, capacitive or over the supply current.
- Measurement over the motor pulses, magnetically signal sensing or over the supply voltage.
- Measurement over the LCD-operating frequency (binary display frequencies).
- Includes contact probes and wires
- For Witschi interactive guide click "documents available to download" (only compatible with Windows)
- Language can be set in English, French or German
- Replacement power adapter: M32301
- Thermo printer available: P38415
- 220 to 240 Volt (if you require a different voltage, please submit an online support request under "products and stock - new item requests (excluding watch & clock parts by brand and movements)")

Officially Appointed Witschi Distributor

Click website "More Information" & "PDF's" for full specification.

For service, calibration & repairs of items inside and outside of the warranty period please submit a quote request via our online support under products & stock - product advice and repairs - Witschi equipment calibration

Code	Description	UOM	Price
T19427	Witschi Analyzer Q1	EACH	£3,350.00
T20777	Witschi Analyzer Q1 & Q Test 6000 Cable Set	EACH	£49.95
T20975	Witschi Analyzer Q1 & Q Test 6000 Movable Contact Probes	EACH	£78.95

Witschi Tech Handy 2



Witschi - New Tech Handy 2

For use in a repair service, the watchmaker needs a testing device which can easily carry out all electrical measurements and tests on quartz watches including measurement of the rate accuracy, the current consumption and test of components of quartz watches. The New Tech Handy II provides all measurement and testing options for technical troubleshooting on quartz watches. Operation is very simple with an extensive number of automated measurement sequences, functional configuration of the controls and a clearly laid out and illuminated display of the results and parameters.

- Witschi insist that UK distributors are only authorised to sell Witschi products to the UK & Eire, for overseas customers we can offer the Greiner & TYMC alternatives.

Specification:

- Rate precision: +/- 0.1s/d
- Rate range: +/- 300s/d
- Rate resolution: 0.1sd
- Vibration: 18000, 19800, 21600, 28800 & 36000
- Measurement time: 1s to 480s

Features:

- Ergonomic all in one design
- LED display screen
- Sensors of highest sensitivity and selectivity for acoustical, magnetic and capacitive signals
- Includes contact probes and wires
- Language is in English
- Replacement power adapter: M32301
- Replacement contact probes: T20975
- Replacement cable set: T20777
- 220 to 240 Volt (if you require a different voltage, please submit an online support request under "products and stock - new item requests (excluding watch & clock parts by brand and movements)")

Officially Appointed Witschi Distributor

Click website "More Information" & "PDF's" for full specification

Available as a Witschi "New Tech Handy 2" or Elma "Watchmaster 2" product (Machines & warranties are exactly the same the only difference is livery / colour).

For service, calibration & repairs of items inside and outside of the warranty period please submit a quote request via our online support under products &

stock - product advice and repairs – Witschi equipment calibration

Code	Description	UOM	Price
W34909	Witschi New Tech Handy II	EACH	£1,895.00

MICROPHONES (WATCH TESTING)

Automatic Microphone, TYMC

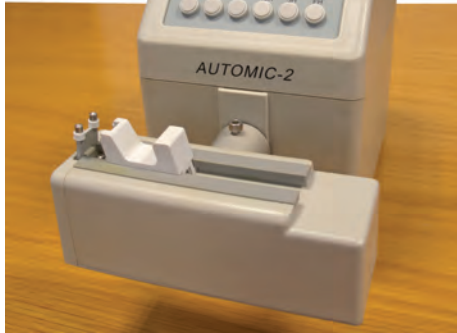

- 3 speeds
- 6 positions
- Will rotate automatically or can be changed by hand
- Can be used with either MTG-4000A (T33493) or MTG-5000A (T39016)

Code	Description	UOM	Price
W44126	MTG Automatic Microphone	EACH	£695.00

Mechanical Microphone, Witschi



Replacement Mechanical Microphones for:

- Witschi Watch Expert 1, 2 & 3
- Elma Watchmatic 1, 2 & 3

Code	Description	UOM	Price
T12040	Microphone for Witschi Watch Expert 2 & 3	EACH	£525.00
T1708A	Microphone for Witschi Watch Expert 1	EACH	£525.00

Microphone & Micromat Protective Box

Witschi - Protective Box for Microphones & Micromat

- Witschi Sound & dust protection box for microphone and Micromat
- Witschi 13.17.537

Officially Appointed Witschi & Elma Distributor



Code	Description	UOM	Price
W34904	Witschi Protective Box For Microphones and Micromat	EACH	£375.00

PRINTERS & SOFTWARE, ROLLS & RIBBONS

Paper Rolls



Timing Machine Paper Rolls

- Plain and self-inking
- Greiner Vibrograph B200/B100 = 36mm
- Genuine Greiner Printing rolls

Code	Description	UOM	Price
T1711	30mm Wide Plain Timing Rolls	EACH	£3.95
T1712	30mm Wide Self Printing Timing Rolls	EACH	£6.50
T1710	36mm Wide Plain Timing Rolls	EACH	£3.95
T1713	36mm Wide Self Printing Timing Rolls	EACH	£6.50

Price breaks available, see website

Auto-Print Kit, Witschi



Witschi Auto-Print Kit

No need to buy a printer, simply hook up your testing machine to a PC with the software installed and see your results displayed on screen (ready for printing or emailing). Compatible with windows operating system.

For:

- Witschi Watch Expert 3 (Cousins ref: T20214)
- Witschi Watch Expert 4 (Cousins ref: T46232)
- Witschi Q1 (Cousins ref: T19427)
- Witschi Analyser Twin (Cousins ref: W34907)
- Witschi Chronoscope S1 (G2) (Cousins ref: W37691)
- Witschi Chronoscope X1 (Cousins ref: T32439)
- Witschi ALC 2000
- Witschi Proofmaster S (Cousins ref: W20802)
- Witschi Proofmaster M (Cousins ref: W34905)
- Elma Spheric Leak Detector (Cousins ref: W32404)

Kit Includes:

- Software USB stick
- AT link cable
- RS232 cable
- Instruction manual

The auto print software is free to download from the Witschi website with any new purchase of piece of Witschi equipment. To register your device and download the software visit <http://www.witschi.com/en/support.html>. Alternatively the software is available to purchase and store on a USB stick as a kit with the required cables & instruction manual provided.

Code	Description	UOM	Price
W38268	Witschi Autoprint PC Kit	EACH	£133.95

Dot Matrix Printer, CBM-910



CBM-910 is a dot-impact printer widely usable with various data communication terminals and measurement terminals. This printer, being extremely compact and equipped with extensive functions, is suitable to a wide range of applications.

- Light Weight
- High Speed Printing (non graphic)
- Paper "near-end" Detecting Function
- Conformity to RS-232C and Centronics
- Wall Mountable
- 2 to 3 pin adapter plug required (A32444)
- Made by Citizen Systems Japan Co. Ltd

For:

- For Elma Watchmatic 2 (T9700) (Witschi Expert 2)
- For Witschi ALC2000 Waterproof Tester (W12041)
- For Greiner Poseidon LT 100 (W9680)

Code	Description	UOM	Price
P15222	Dot Matrix Printer, CBM-910	EACH	£325.00
P30571	CBM-910 Printer Black Ribbon	EACH	£10.50
P30572	CBM-910 Printer Paper Roll	EACH	£3.65



Thermal Printer, Martel (for Greiner)



Martel Thermal Printer MCPK7830X6 for:
 • Greiner Poseidon (Cousins ref: W9680)
 • Greiner Compact 900
 • Greiner LC Prime

Martel Thermal printer paper roll Cousins ref: P32776

Code	Description	UOM	Price
P42036	Martel Thermo Printer	EACH	£275.00

Thermal Printer, Martel (for Witschi)



Martel Thermal Printer - Martel MCP 7810-244

Kit includes:

- Martel Thermal Printer, MCP 7810
- Power cable
- Cable for connecting to the below machines (replacement our code P50668)

For:

- Elma Watchmatic 3 (Cousins ref: T20113)
- Witschi Watch Expert 4 (Cousins ref: T46232) - requires connection cable P45737
- Witschi Watch Expert 3 (Cousins ref: T20214)
- Witschi Q1 (Cousins ref: T19427)
- Witschi Analyser Twin (Cousins ref: W34907)
- Witschi S1 (Cousins ref: T20798)
- Witschi ALC 2000
- Witschi Proofmaster S (Cousins ref: W20802)
- Elma Spheric Leak Detector (Cousins ref: W32404)

Code	Description	UOM	Price
P15224	Martel Thermo Printer	EACH	£224.95
P32776	Martel Thermo Printer Paper Roll	EACH	£7.25
P50668	Printer Cable	EACH	£74.95
P45737	Printer Cable for Witschi Watch Expert 4	EACH	£59.95

Price breaks available, see website

Thermal Printer, Witschi



Witschi Thermal Printer - With Automatic Cutter

For:

- Witschi Watch Expert 3 (Cousins ref: T20214)
- Witschi Watch Expert 4 (Cousins ref: T46232)
- Witschi Q1 (Cousins ref: T19427)
- Witschi Analyser Twin (Cousins ref: W34907)
- Witschi S1 (Cousins ref: T20798)
- Witschi ALC 2000
- Witschi Chronoscope S1 (G2) (Cousins ref: W37691)
- Witschi Chronoscope X1 (G2) (Cousins ref: T32439)
- Witschi Chronoscope X1 (G3) (Cousins ref: T44313)
- Witschi Proofmaster S (Cousins ref: W20802)
- Elma Spheric Leak Detector (Cousins ref: W32404)

Power range 100 to 240 volt (can be used either at 240 volt or 115 volt)

Features:

- Highly efficient and compact
- Automatic cutter cuts the paper when the results have finished printing
- Fast printing speed
- Bluetooth capability, please see our code B49303
- Can connect up to 10 devices to a single printer (via bluetooth capability)
- Replacement printer paper roll Cousins ref: P32776

Code	Description	UOM	Price
P38415	Thermo Printer with Automatic Cutter	EACH	£389.95

Thermal Printer, Witschi - Bluetooth Module



Connect your Witschi device to your printer via Bluetooth to have a wireless printer!

- Connect your Witschi device to your printer via Bluetooth
- No wires required
- Simply insert the bluetooth module into the printer
- Then connect the dongle to the Witschi device you wish to print from
- Up to 10 devices can be connected to one printer (each device will require its own dongle)
- 10 metre range (each device can be up to 10 metres away from the printer)

Bluetooth enabled devices:

- Witschi Watch Expert 4 (Cousins ref: T46232)
- Witschi Chronoscope X1 (G3) (Cousins ref: T44313)

- Witschi Chronoscope S1 (G2) (Cousins ref: W37691)

Code	Description	UOM	Price
B49303	Witschi Bluetooth Dongle	EACH	£78.95
B49302	Witschi Bluetooth Printer Module	EACH	£78.95

Ribbon (Greiner B200)



Timing Machine Ribbon

- Ribbon and reels complete.
- Ribbon is Dry
- Use a Screwdriver, remove circular clip which is fixed to the end of the roller spindle
- Place the new roller on it's spindle and fix circular clip with help of a pair of flat nosed pliers

Code	Description	UOM	Price
T7710	Greiner B200 Timing Machine Ribbon & Reels	EACH	£39.50

Ribbon by Size



Timing Machine Ink Ribbon

- Pre-inked continuous tape loops

Code	Description	UOM	Price
T7711	Timing Machine Ink Ribbon width 33mm, length 260mm	PACK*10	£25.25

Voltage Converter

Made in UK



See Page 1162

ORDER tracking

ONLINE ORDER STATUS

SAME DAY DISPATCH

ROTATION (TIMING) MACHINES



Watch winders for service workshops, watchmakers and manufacturers

Watch winders are used both for the manufacturing and for the servicing and maintenance of automatic watches. The units simulate the wearing of the watch on the wrist and test and carry out the winding of the watch.

Bergeon Rotation Machine



Rotation Machine - Bergeon - New Style

Machines for testing: FINAL-TEST

- 1 or 4 revolutions per minute (RPM)
- Bergeon Swiss
- For testing the working of watches
- For winding automatic watches
- For checking mechanical parts of quartz watches
- Especially the calendar mechanism
- Can be used in horizontal or vertical position
- For 6 watches with bracelets or without bracelets
- New foam fixing straps
- Bergeon 7802 & 7803
- 230 or 115 Volt

Dimensions:

- Overall diameter: Ø300mm
- Base diameter: Ø160mm
- 110mm tall
- Weight: 2Kg

Code	Description	UOM	Price
R39969	1RPM Rotation Machine, 230 Volt	EACH	£550.00
R48649	1RPM Rotation Machine, 115 Volt	EACH	£550.00
R39968	4RPM Rotation Machine, 230 Volt	EACH	£579.95
R48650	4RPM Rotation Machine 115 Volt	EACH	£525.00
R50462	Arm with Foam Cushion & Elastic Fastening	EACH	£18.75
R53040	Support Stand for Rotation Machine	EACH	£229.95
Price breaks available, see website			

Cousins Rotation Machine



Cousins Rotation Machine - Made in Italy

- 6 Arm, 6 Clamps
- To be used horizontally.
- Capacity 6/12 watches
- 4 revolutions per minute with each arm turning on gears

Code	Description	UOM	Price
R1467	Cousins Rotation Machine	EACH	£375.00
R1468A	Clip for Cousins Rotation Machine	EACH	£14.95
R1468	Clip Set (6) for Cousins Rotation Machine	PACK*6	£65.60

Elma Cyclomatic 12 Arm



Rotation Machine - Elma - Cyclomatic - 12 Arm

For winding and testing of automatic watches.

Features: -

- 12 arms with clips
- 6 rotations of 360° per minute
- Geared 'rolling' action of all 12 arms
- Table or wall mountable
- Spare clips also available (code R4706 or R4706A)
- Dimensions approx: 420 x 200 x 200mm

Code	Description	UOM	Price
R4705	Cyclomatic 12 Arm Rotation Machine, Elma 3340000000	EACH	£750.00
R4706	Clip, Elma 3000006067	EACH	£10.95
R4706A	Clip with Arm, Elma 3000006066	EACH	£12.50
R7653	Mains Transformer, Elma 3346000000	EACH	£24.95
R32432	Synchronous Motor with Gear, Elma 1016118	EACH	£260.00

Elma Cyclomotion



Rotation Machine - Elma Cyclomotion

Watch winders for service workshops, watchmakers and manufacturers

Watch winders are used both for the manufacturing and for the servicing and maintenance of automatic watches. The units simulate the wearing of the watch on the wrist and test and carry out the winding of the watch.

The new Elma Cyclomotion boasts a number of new features. The unit is not only capable of winding very large and heavy watches, but can also change the sense of rotation. By means of a specialized clip, mechanical watch works that need to be wound in one direction only can be tested. On a unit which is equipped with the right combination of clips, watch works that wind up in one or both directions can be wound simultaneously. Depending on the set speed (1 or 4 rpm), both permanent tests or quick windings are an option.

The Cyclomotion is controlled via soft touch keys on the front.

The high quality standard shows not only through the casing, the simple handling, the stability and the innovative plastic-coated clips, but also through the virtually silent yet powerful motor which has an integrated safety clutch and so efficiently protects both unit and watches in case of an unintended reaching inside.

A special feature is the optional "Protector" cover. It can be closed to protect the watches against dust and mechanical damage. The cover is opened via two quarter shells actuated synchronously in damping springs.

Most Popular Model: R32730

Click website "More Information" & "PDF's" for full specification.

Code	Description	UOM	Price
R32729	Cyclomotion 12 Watches without Protective Cover - Elma 1035171 + 1035190 (x6)	EACH	£1,195.00
R32730	Cyclomotion 24 Watches without Protective Cover - Elma 1035171 + 1035192 (x6)	EACH	£1,395.00
R32731	Cyclomotion 12 Watches with Protective Cover - Elma 1035170 + 1035190 (x6)	EACH	£2,100.00
R32732	Cyclomotion 24 Watches with Protective Cover - Elma 1035170 + 1035192 (x6)	EACH	£2,232.00
R32733	Cyclomotion without Protective Cover, without Clips - Elma 1035171	EACH	£1,100.00
R32734	Cyclomotion with Protection Cover, without Clips - Elma 1035170	EACH	£1,920.00
R32735	Clip for 2 Wristwatches - Elma 1035190	EACH	£29.95
R32736	Clip for 4 Wristwatches - Elma 1035192	EACH	£55.50



ONLINE ORDER STATUS

PRICE PROMISE GUARANTEE



TRADE SUPPLIER

R32737	Clip for 2 Wristwatches, Left / Right - Elma 1035359	EACH	£41.95
R32738	Clip for 4 Wristwatches, Left / Right - Elma 1035360	EACH	£56.95
R32739	Clip for 4 Wristwatches without Straps Elma 1035361	EACH	£72.95
R32740	Wall Mount, Elma 1035701	EACH	£31.95
R40223	Watch Box, Elma 1053528	EACH	£97.95

ROTATION (STORING) & SOLAR MACHINES

Cousins Watch Winder & Storage Box



- High Quality - Made in Japan
- Rotates clockwise or anticlockwise
 - Auto programme which rotates the watch for 10 minutes, with a 3 hour pause, then begins again
 - Ultra quiet motor
 - Superb carbon fibre look
 - 145 x 145 x 150mm
 - Supplied with presentation box
 - With blue LED light to show the machine is on

Code	Description	UOM	Price
W40314	Cousins Watch Winder & Storage Box	EACH	£69.95

Elma Cyclomatic Duo



Rotation Machine - Elma - Cyclomatic Duo

- 2 watch capacity auto watch winder.
- Dimensions: 190 x 160 x 110mm

- Protects stored automatic watches
- Battery or optional mains operation
- Pre-programmed rotation modes
- Window display potential

Code	Description	UOM	Price
R4704	Cyclomatic Duo Rotation Machine, Elma 3720100000	EACH	£249.95

WATCH TOOL KITS

Battery Quickchange Kit



Battery Quickchange Kit

- 7 piece kit
- Everything you need for battery changes
- Supplied in plastic wallet
- Made in India

- Kit contains:
- Case opener, twist action for screw on case backs
 - Case opener, for snap on case backs
 - Case knife with wooden handle (K39636)
 - Dust off brush (S39290)
 - Pliers (snipe nose) (P4780)
 - Screwdriver, Ø2.00mm blade
 - Tweezers (plastic) (T34701)
 - Tweezers (brass) (T36486)

Code	Description	UOM	Price
K47430	Battery Quickchange Kit	EACH	£9.75

Bracelet Adjusting Kit



Bracelet Adjusting Kit

- Kit contains:
- Wooden bracelet holding block (B36466)
 - Bracelet pin removing punches: Ø0.80mm & Ø1.00mm
 - 4 replacement pins: 2 x Ø0.80mm & 2 x Ø1.00mm
 - Small ball pein hammer (H39469)

Code	Description	UOM	Price
K47062	Bracelet Adjusting Kit	EACH	£5.50

Bracelet Adjusting Kit



Bracelet Adjusting Kit - Split Pin Box Set

- Kit contains:
- Box set of 180 watch bracelet split pins, sizes 5 to 22mm
 - Bracelet holding block
 - Bracelet pin removing set
 - Watchmakers hammer
 - Flat nose spring loaded pliers
 - All supplied in plastic wallet

Code	Description	UOM	Price
B38760	Bracelet Adjusting Kit	EACH	£6.95

Bracelet Adjusting & Case Opening Kit



- Value Tool Kit
- Adjusting Bracelets
 - Opening and Closing Watch Case Backs
 - 12 pieces
 - Supplied in a Transportable Wallet

Code	Description	UOM	Price
K49423	Bracelet Adjusting & Case Opening Kit	EACH	£10.95

The Theory of Horology



BEST SELLER

See Page 1529

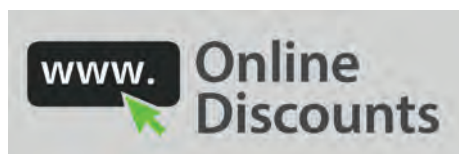

Strap Removing & Case Opening Kit

VALUE



Value Tool Kit

- Removing straps
- Opening and Closing Watch Case Backs
- 10 pieces
- Supplied in a transportable secure plastic box
- Supplied with 120 spring bars, 12 different sizes

Contents:

- AA Tweezers
- Plastic tweezers
- Spring bar removing tool
- Eyeglass
- Case opening knife
- Case opening twist action tool
- Ø1.00, 1.20 & 1.60mm screwdrivers with spare blades
- Pack*120 spring bars

Code	Description	UOM	Price
K49625	Case Opening & Strap Adjusting Kit	EACH	£14.95

Watchmakers Quick Service Kit, Bergeon Swiss



Bergeon 7812 - Swiss Made

- 18 specialised tools & accessories
- Battery service
- Bracelet changing and shortening
- Case back opening and closing
- Supplied in plastic carry case, easy storage and transportation
- Sturdy protective foam inserts
- Handy kit for watchmakers
- All Bergeon Swiss tools

Kit contains:

- Jaxa mini (Bergeon 2819-MINI)
- 2.5 Screw rim eyeglass (Bergeon 2611-2.5)
- Plastic tweezers with counterweight (Bergeon 6460-P)
- 00 Anti-magnetic, stainless steel tweezers (Bergeon 7026-00)
- Ø1.00mm Stainless steel ergonomic screwdriver, with spare blade (Bergeon 30081-100)
- Ø1.60mm Stainless steel ergonomic screwdriver, with spare blade (Bergeon 30081-160)
- Case opening knife (Bergeon 7403)
- Flat nose pliers (Bergeon 2510-N)
- Bracelet pin removing tool, with two Ø0.80 pins (Bergeon 7230)
- Microfibre cloth, 220 x 220mm (Bergeon 7039)
- Flexible wrist measuring band (Bergeon 6789-N)
- Spring bar tool (Bergeon 6767-S)

- Spare pin & fork ends for spring bar tool (Bergeon 6767 A & B)

Code	Description	UOM	Price
K39010	Watchmakers Quick Service Kit, Bergeon Swiss	EACH	£154.95

Watchmakers Master Service Kit, Bergeon Swiss



Bergeon 7815 - Swiss Made

- 48 specialised tools & accessories
- Battery service
- Bracelet changing and shortening
- Case back opening and closing
- Supplied in plastic carry case, easy storage and transportation
- Sturdy protective foam inserts
- Extensive kit for watchmakers
- All Bergeon Swiss tools

Kit contains:

- Jaxa (Bergeon 2819-08)
- 3 x Flat, 3 x Notch, 3 x round hole & 3 x oyster tool bits (Bergeon 2819.A, 2819.B, 2819.C, 2819.D)
- Bracelet press with 6 pins, 10 blades & 2 adjustable bases (Bergeon 8745)
- Bracelet block (Bergeon 6744-P)
- 2.5 Screw rim eyeglass (Bergeon 2611-2.5)
- Plastic tweezers with counterweight (Bergeon 6460-P)
- 1 Anti-magnetic, stainless steel tweezers (Bergeon 7026-1)
- Ø1.00mm Stainless steel ergonomic screwdriver, with 2 spare blades (Bergeon 30081-100)
- Ø1.20mm Stainless steel ergonomic screwdriver, with 2 spare blades (Bergeon 30081-120)
- Ø1.40mm Stainless steel ergonomic screwdriver, with 2 spare blades (Bergeon 30081-140)
- Ø1.60mm Stainless steel ergonomic screwdriver, with 2 spare blades (Bergeon 30081-160)
- Ø2.00mm Stainless steel ergonomic screwdriver, with 2 spare blades (Bergeon 30081-200)
- Case opening knife (Bergeon 4932)
- Flat nose pliers (Bergeon 2510-N)
- Microfibre cloth, 220 x 220mm (Bergeon 7039)
- Flexible wrist measuring band (Bergeon 6789-N)
- Spring bar tool (Bergeon 3135)
- Spare pin & fork ends for spring bar tool (Bergeon 3153-R)
- Leather buff with buff protector (Bergeon 1282A & 4056-6)
- Steel Ruler (Bergeon 2819-08-C)
- Ø15 x 30mm plastic boxes x 6 (Bergeon 2963-B)
- Dust blower (Bergeon 30540)

Code	Description	UOM	Price
T44217	Watchmakers Master Service Kit, Bergeon	EACH	£550.00



Watchmakers Basic Tool Kit

VALUE



Watchmakers Professional Tool Kit

- 20 specialised tools & accessories
- Battery service
- Bracelet changing and shortening
- Case back opening and closing
- Supplied in varnished wooden box
- Made in India

Kit Includes:

- Adhesive, all purpose
- Bracelet pin remover with spare pins
- Bristle brush (B45713)
- Carborundum stone (S4746)
- Cutters (Side)
- Dust blower
- Eyeglass (x3 magnification)
- Oil for quartz watches
- Oil cup (O7983)
- Oiler
- Pegwood, Ø3mm (pack*24) (P1111)
- Pin vice (double ended) (P5314)
- Pliers (Flat nose)
- Screwdriver set of 9
- Screwdriver Ø3.00mm (for clocks)
- Screwdriver Ø6.00mm (for clocks)
- Staking block (S47502)
- Tweezers, No.3
- Tweezers, No. AA
- Tweezers (cutting), No.D (T34700)

Code	Description	UOM	Price
K47428	Watchmakers Basic Kit	EACH	£33.95

Watchmakers Professional Tool Kit



Watchmakers Professional Tool Kit

- 26 specialised tools & accessories
- Battery service
- Bracelet changing and shortening
- Case back opening and closing
- Supplied in faux leather wallet
- Made in India

Kit Includes:

- Bracelet holding vice (B37143)

- Buff stick, black felt (B39032)
- Case cushion
- Case knife with wooden handle (K39636)
- Case opener (Twist action) (C32395)
- Dust blower
- Eyeglass, double lens (x10 magnification)
- Eyeglass, wooden (x5 magnification) (E37154)
- Hand fitting tools, set of 3 (H37241)
- Hand remover (H37692)
- Hand removing levers (H39643)
- Micro choc bracelet pin remover
- Movement holder (M38222)
- Oilers, set of 3
- Pin chuck with wooden handle (V39482)
- Polishing cloth
- Quartz watch oil (2ml)
- Rub off cleaning compound
- Reamers, set of 10 in plastic tube
- Scratch brush (fibreglass) (B0226)
- Sharpening stone (55 x 25 x 15mm) in wooden box
- Spring bar remover, aluminium (S42901)
- Tweezers, anti magnetic No.5
- Tweezers, anti magnetic No.3
- Tweezers, anti magnetic No.AA (T39593)
- Tweezers, plastic with stabiliser (T37828)

Code	Description	UOM	Price
K47429	Watchmakers Professional Kit	EACH	£49.95

WATER PROOF TESTING

WATERPROOF TESTING MACHINES

• *Witschi insist that UK distributors are only authorised to sell Witschi products to the UK & Eire, for overseas customers we can offer the Greiner & TYMC alternatives.*

Bergeon 5555/10 Wet Tester



Bergeon 5555/10 - Wet Tester

New apparatus for testing the water resistance of watch cases

- Air pressure system
- Removable cylinder for draining
- Connector for compressor (valve available separately)
- Manual pressure from 0 to 10 atm.
- Hook for synthetic matter watch
- Control Capacity : 0-11 atm. (security at 12 atm)

- Built in aluminium cast iron
- Strong, very stable
- Cylinder Ø: 70mm
- Volume capacity: 2 watches
- Dimensions: 275 x 167.5 x 390 mm

Click website "More Information" & "PDF's" for full specification.

Code	Description	UOM	Price
W32292	Bergeon 5555/10 Water Tester	EACH	£925.00
C36653	Valve for Compressor	EACH	£119.95
C36963	Connector Hose for Compressor, UK	EACH	£19.95

Bergeon 5555/98 Wet Tester



Bergeon 5555/98 - Wet Tester

Wet Pressure System 3 Bar Wet Test. Air pressure system 3 atmospheres. The advantages offered by this pressure apparatus are due to the fact that a watch can be tested under normal wear conditions. Diameter or opening-64mm. 2 Watch capacity.

- Chamber diameter 64mm
- Pressure capacity 0-3 ATM (approx. 0 to 30 meters)
- Leaks revealed by bubble stream
- Dimensions: 245 x 150 x 290mm HT

Click website "More Information" & "PDF's" for full specification.

Code	Description	UOM	Price
W1838	Bergeon 5555/98 Waterproof Tester	EACH	£545.00

Calypso Wet Tester



Calypso - Wet Pressure System - 10 Bar

Italian made, with simple operation.

- Pressure capacity 0-10 Bar (approx. 0-100 meters)
- Leaks revealed by bubble stream
- Manual release valve for safety
- Dimensions approx. 170 x 200 x 270mm (LxDxH)
- Chamber outside diameter Ø90mm, inside diameter Ø80mm
- Full instructions included

Versions available:

- W51141: Tester with compressor connection, reach 10 bar quickly and effectively (compressor supplied separately, our code C1837)
- W51140: Tester with both compressor & hand pump (compressor supplied separately, our code C1837)
- W1839: Tester with hand pump, no need for a compressor

Compressor connection on the Calypso takes a Ø6mm tube, see our code T54144.

Adapter to fit a Ø6mm tube to our compressors is available under our code C41895.

Code	Description	UOM	Price
W51141	Calypso Waterproof Tester (Compressor Connection)	EACH	£370.00
W51140	Calypso Waterproof Tester (Compressor Connection & Hand Pump)	EACH	£395.00
W1839	Calypso Waterproof Tester (Hand Pump)	EACH	£375.00

Elma Leak Controller Vacuum Tester



Elma - Leak Controller - Vacuum Tester

- Water Resistant?
- Water proof?

Q: (Customer) - Do you do water testing?

A: What sort of watch do you have?

If it's a sports/divers watch, do you need it tested to diving depths, if so it requires a pressure test (which is a more expensive test).

However, there is no need to test to depths of 100 metres, why test to 100 metres when you are:

- washing up
- showering
- swimming
- washing the car

Most watches, including a lot of sports & divers watches, don't actually go anywhere near these depths

Meet the Leak Controller – affordable testing for most watches - guaranteed waterproof for everyday use.

Vacuum testing is ideal for most watches, pressure testing compacts watch cases trying to force air in, however a vacuum test works in the opposite way by measuring if air wants to escape the case thus if there is a leak it will show immediately, it also will identify if there is a potential leak as the gauge pointer will continue beyond the designated parameter demonstrating that the sealing areas (glass, case or crown gaskets) are potentially vulnerable.

Restrictions and limitations:

For watches with very solid cases (screwed back) and sapphire crystal the deformation is very small.

- Click website "More Information" & "PDF's" for full specification
- 220 to 240 Volt (230 to 110 volt converter please see our code A52044)

Elma's Principal UK Distributor

Code	Description	UOM	Price
W1832	ELMA Leak Controller	EACH	£725.00
W1834	Elma Leak Controller Revealing Gel	EACH	£16.75

Greiner Leak Checker Prime

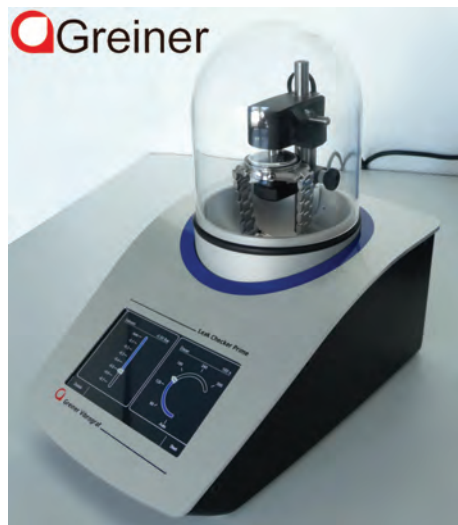

The new Leak Checker Prime is the perfect mix of technology and good design. Able to test for leaks up to -0.7 bar vacuum, it provides everything you would expect of a modern, easy-to-use leak testing unit. The unit needs no additional, expensive compressor.

Particularly for watch maintenance services with a large volume of repairs, vacuum tests suffice completely. The vacuum test reproduces normal strains on the watch when worn normally and other under conditions such as in the shower, when swimming, snorkelling, etc. For diving watches as well as a more extensive range of tests, we recommend the Poseidon LT 100 (our code W9680)

Key features:

- Attractive, timeless design
- Suitable for all watch types including small ceramic watches
- With accurate, robust pressure sensor
- Vacuum created by an internal pump
- Vacuum can be freely selected and programmed in steps of 0.1 bar up to -0.7 bar
- Testing time can be freely selected and programmed up to 300 sec
- Intuitive user interface, with results displayed on a colour, 5" TFT capacitive touch screen (800 x 480 pixels)
- Instant printout of results with Martel thermal printer, with printout also possible via LAN and USB
- Enables connection to a network via Ethernet and USB
- Extremely cost-effective
- See "document" link above for full instruction manual
- Greiner Switzerland

Also available:

- Martel printer, our code P42036

Code	Description	UOM	Price
W53390	Greiner Leak Checker Prime	EACH	£1,895.00

Online Discounts

Helical Hairspring Escapement Demonstration Model



See Page 210

Greiner Poseidon LT-100 Pressure and Vacuum Tester



Greiner - Poseidon LT-100 - Pressure and Vacuum Tester

The latest and most advanced dry water tester of its kind from Greiner, Switzerland. The new LT-100 utilizes intelligent software to identify and assess case deformation while testing for leaks and features special stabilizing circuitry for automatic and reliable results, which are then delivered as a numeric or analogue colour diagram on the data screen.

Both pressure and vacuum modes have test capacities of 0.7 to 10 bar (approx 10-100 mtrs) and the five pre-determined programs plus any one of seven user chosen individual test cycle settings provide simple procedural operation and ensure confident results.

Printer compatible and built to exceptionally high standards.

- Requires compressor = Cousins Ref. C1837
- CBM190 Printer = Cousins Ref. P15222
- Martel Thermo Printer = Cousins Ref. P42036

Specifications:

- Length 320mm
- Depth 250mm
- Width 280mm
- Weight: 7.5kg
- Power range 100 to 240 volt (can be used either at 240 volt or 115 volt)

Click website "More Information" & "PDF's" for full specification.

Furring caused by humidity (condensation) and dirt (dust particles) impair the function of the valves of the Poseidon LT-100. Greiner therefore recommend that your compressor is provided with a maintenance unit in order to prevent damage to the equipment. Please see PDF for full explanation

Code	Description	UOM	Price
W9680	Greiner Poseidon LT-100 Waterproof Tester Pressure and Vacuum	EACH	£3,595.00
W38755	Greiner Poseidon Maintenance Kit	EACH	£295.00

PRICE PROMISE GUARANTEE ✓

Compressors

See Page 701



Lititz Diver 125 Wet Tester



Lititz Diver 125 - Up to 125 Bar/125 Metres - Omega Approved

- Up to 125 bar/atmospheres (1250 metres)
- Omega approved
- Rugged anodized construction
- 50mm chamber depth
- 63mm chamber diameter
- Clear lens to monitor the test in progress
- Comes with watch holder and water bottle
- Made in USA

Dimensions:

- Weight: 6.4Kg
- 20cm x 28cm x 10cm (H x W x D)

Code	Description	UOM	Price
W40284	Lititz Diver 125 Water Tester	EACH	£2,995.00

Roxer Natator 40 Wet Tester



Roxer - Natator 40 (up to 40 bars - 400 meters)

- Pressurized water
- Ideal for unit control and after-sales service
- Pressure up to 40 bars (400 meters)
- Bowl and drip tray with water in stainless steel
- No connection required
- Autonomous
- Gauge incorporated.

Technical Data:

- Pressure Scale 0 to 40 bar
- Tank Height 50 mm
- Tank Internal Diameter Ø65mm
- Tank Capacity: 0.21 litre
- Capacity 1

Dimensions & weight:

- Length 220mm
- Width 270mm
- Height 250mm
- 8.5kg

Professionally made high specification tester requiring only an additional hotplate (ref H2816) as part of the dual procedure to conclusively reveal if a leak occurred during the pressurisation cycle at the chosen Natator setting- the main unit requires no compressor or electrical feed.

Pressure is applied to the stainless steel chamber via the crank handle until the required gauge reading from 1 to 40 bar is achieved. The watch can be viewed through the top inspection glass and depressurisation is by reversing the crank direction to zero.

Click website "More Information" & "PDF's" for full specification.

Code	Description	UOM	Price
W12350	Roxer Natator 40 Water Tester	EACH	£3,795.00
W31683	Roxer Natator 40/125 Watch Holder Basket	EACH	£79.95

Roxer Natator 125 Wet Tester



Roxer - Natator 125 (up to 125 bars - 1250 meters)

- Pressurized water
- Ideal for unit control and after-sales service
- Pressure up to 125 bars (1250 meters)
- Bowl and drip tray with water in stainless steel
- No connection required
- Autonomous
- Gauge incorporated

Technical Data:

- Pressure Scale 0 to 125 bar
- Inside Tank Height 65 mm
- Tank Internal Diameter Ø80mm
- Tank Capacity: 0.33 litre
- Capacity 1

Dimensions & weight:

- Length 310mm
- Width 330mm
- Height 300mm
- 12kg

Replacement Watch Holder Basket: Item Code W31683

Professionally made high specification tester requiring only an additional hotplate (ref H2816) as part of the dual procedure to conclusively reveal if a leak occurred during the pressurisation cycle at the chosen Natator setting- the main unit requires no compressor or electrical feed.

Pressure is applied to the stainless steel chamber via the crank handle until the required gauge reading from 1 to 125 bar is achieved. The watch can be viewed through the top inspection glass and depressurisation is by reversing the crank direction to zero.

Click website "More Information" & "PDF's" for full specification.

Code	Description	UOM	Price
W19476	Roxer Natator 125 Water Tester	EACH	£4,795.00
W52699	Clip for Roxer Chamber Handle	EACH	£2.20

Roxer Revelator R1



Roxer Revelator R1

The Revelator R1 is a fully electronic tester with an integrated heating plate which allows you to determine the condensation susceptibility of a watch quickly & accurately, effectively replacing the present drop test. The 20 pre-defined test programs allow you to determine the extent of testing required for the different levels of watch waterproof ability you encounter. The user-friendly touch screen ensures easy handling and operation.

In contrast to the drop test, the tester is able to set the watch to sustained state of shock, in which the temperature is maintained uniformly over the set period of time, giving the most accurate and reliable results.

- For revealing condensation on crystals
- Can be used with crystals up to 5mm thick
- The cold point setting can also reveal condensation on thick crystals
- Stability of hot and cold temperatures, ensuring test repeatability
- Heating plate included
- Programmable temperature and time parameters
- Touch-screen
- Made in Switzerland

Specifications;

- Heating temperature: 40 to 50 °C
- Cooling mode temperature: 4 to 18 °C
- Power range 100 to 240 volt (can be used either at 240 volt or 115 volt)
- Dimensions: 220 x 310 x 115mm
- Weight: 4.5Kg

Code	Description	UOM	Price
R47066	Roxer Revelator R1	EACH	£4,695.00

Witschi ChronoProof Pro (Integrated Compressor) 3 Bar



Witschi - ChronoProof Pro - 3 Bar

The compact ChronoProof Pro with integrated compressor turns you into a specialist able to reliably seal test all types of wristwatch in no time at all. No parametrisation, no programming – just insert the watch, close the test chamber and the rest place automatically takes place. Thanks to the integrated printer, you can also have the test result in black and white. You will find that this compact and stylish unit

looks just as good on any sales desk as it does on a workbench.

- Witschi insist that UK distributors are only authorised to sell Witschi products to the UK & Eire, for overseas customers we can offer the Greiner & TYMC alternatives.

Features:

- Worldwide one-of-a-kind: integrated compressor: The ChronoProof Pro is the first seal testing device with an integrated compressor for generating a vacuum and pressure, which makes it particularly compact and handy
- Integrated printer : Thanks to the integrated printer, you can print out your test results at the touch of a button. The header of the print-out slip can be individually configured, for example with your logo or company name
- Reliable test results: Reliable results thanks to high-precision Witschi technology: the ChronoProof offers measurement resolution of 0.02 µm, in other words 1/5000 of the thickness of an average human hair
- Automatic parametrisation & test cycle: The test cycle starts automatically on closing the test chamber. Stabilisation and measurement times are automatically adapted to suit the watch. It is not necessary to create programs
- Touchscreen: Easy user guidance thanks to modern day touchscreen
- The new PC software allows you to create your own single and double tests program or to use the automatic mode. All created test programs and ticket layouts will be saved as file into the memory of the ChronoProof and PC, until the parameters will be changed by the user.
- Three colours available: The ChronoProof Pro is available in aluminium, steel and ruby

Technical specifications:

- Vacuum: programmable between -0.5 up to -0.2
- Pressure: Programmable between 0.2 up to 3 bar
- Measuring range deformation: -300 to 1000 µm
- Sensor resolution: Typically 0.02 µm
- Maximum watch size (case only):
 - Diameter = 70 mm
 - Thickness = 28 mm
- Maximum strap diameter (e.g. in the case of non-flexible straps):
 - Horizontal = 85 mm
 - Vertical = 65 mm
- Interface: USB 2.0
- Dimensions: 155 x 220 x 300mm (W x D x H)
- Power range 100 to 240 volt (can be used either at 240 volt or 115 volt)

Click website "PDF's" for full specification.

For service, calibration & repairs of items inside and outside of the warranty period please submit a quote request via our online support under products & stock - product advice and repairs – Witschi equipment calibration

Code	Description	UOM	Price
W36030	Aluminium with Printer Witschi ChronoProof Pro	EACH	£2,995.00
W36028	Ruby with Printer Witschi ChronoProof Pro	EACH	£2,995.00
W36029	Steel with Printer Witschi ChronoProof Pro	EACH	£2,995.00
T40120	ChronoProof Pro Printer Rolls	EACH	£5.85



Heating Plate

See Page 754



Witschi Proofmaster M Pressure and Vacuum Tester



Witschi – Proofmaster M - Pressure and Vacuum Tester

Professional Equipment for Leak Tests

- Witschi insist that UK distributors are only authorised to sell Witschi products to the UK & Eire, for overseas customers we can offer the Greiner & TYMC alternatives.
- 9 predefined universal test programmes
- 45 customer specific programmable test cycles
- "Quick select" function allows automatic generation of the ideal test programme based on the selection of the watch characteristics
- Special programme for the localization of leaks
- Vacuum testing from -0.2 to -0.8 bar in steps of -0.1 bar
- Pressure testing from 0.2 to 10 bars in steps of 0.1 bar
- Built in vacuum generator
- Automatic determination of the required test time based on the programmed tolerance values with automatic repetition of the test if an ambiguous result is recorded
- Test time can also be set manually, from 15 to 300 seconds
- Automatic stabilisation or alternatively stabilisation time can be set manually, from 15 to 300 seconds
- Measurement of the deformation:
 - Measurement range: -300 to +1000 µm.
 - Resolution of the display: 0.01 µm.
 - Resolution of the sensor: typical 0.02 µm
- Colour touch screen
- Limit of case size(with or without strap):
 - Diameter: Ø70 mm
 - Thickness: 28 mm
- English, French, German, Spanish and Italian display available
- Supplied with flexible hose and compressor connector
- See PDF for full information
- Replacement power adapter: M32301
- For Witschi interactive guide click "documents available to download" (only compatible with Windows)
- 220 to 240 Volt (230 to 110 volt converter please see our code A52044)

The Proofmaster M (Spheric) is the instrument of choice whenever extreme user friendliness is required. Especially suited for the repair service, specialised trade outlets or in manufacturing, 9 pre-defined universal programmes, 45 freely programmable test cycles and clear menu guidance provides the simplest handling and the most reliable examination & testing for all watches. This professional instrument draws the attention by its wholly automated "close and test" sequence, its intuitive operation with a colour touch screen and by its excellent, sleek design

The new, special Leak Finder Programme opens a new dimension for the localisation of watch leakages in water.

The instrument, equipped with a USB interface, can be networked by using the optional proofmaster M/S software.

Accessories (available separately unless stated):

- Mains Adaptor (included): Cousins ref. M32301
- Compressor: Cousins ref. C1837
- Auto-print kit: Cousins ref. W38268

For service, calibration & repairs of items inside and outside of the warranty period please submit a quote request via our online support under products & stock - product advice and repairs – Witschi equipment calibration

Code	Description	UOM	Price
W34905	Witschi Proofmaster M Waterproof Tester	EACH	£4,750.00

Witschi Proofmaster S Pressure and Vacuum Tester



Witschi - Proofmaster S - Pressure and Vacuum Tester

- Witschi insist that UK distributors are only authorised to sell Witschi products to the UK & Eire, for overseas customers we can offer the Greiner & TYMC alternatives.

Professional Equipment for Leak Tests

- 7 predefined universal test programmes
- 10 programmable test cycles
- Special programme for the localization of leaks
- Testing by means of pressure and/or vacuum (-0.8 to 10 bar)
- High-resolution deformation sensor (nanometer range)
- Watches can be tested with or without strap or bracelet (up to Ø70mm and 28mm thickness)
- Vacuum: 0.2 to 0.8 bar
- Pressure: 0.2 to 10 bar
- Replacement for ACL2000
- Compressor required (Cousins Ref. C1837)
- Supplied with flexible hose and compressor connector
- See PDF for full information
- For Witschi interactive guide click "documents available to download" (only compatible with Windows)
- Replacement power adapter: M32301
- 220 to 240 Volt (230 to 110 volt converter please see our code A52044)

The Proofmaster S is specially suited for the repair service, for the specialised trade. Pre-defined universal programmes, freely programmable test cycles and clear menu guidance provides the simplest handling and a reliable examination/testing for all watches.

The new, special Leak Finder Programme opens a new dimension for the localisation of watch leakages in water.

The instrument, equipped with a USB interface, can be networked by using the optional WiCoTrace software.

Accessories (available separately unless stated):

- Mains Adaptor (included): Cousins ref. M32301
- Compressor: Cousins ref. C1837
- Auto-print kit: Cousins ref. W38268 (Witschi Proofmaster only)

- Printer: Cousins ref. P15224 or P38415
- Auto Print Kit: Cousins ref. W38268

Available as a Witschi or Elma Product (Machines & warranties are exactly the same the only difference is livery / colour)

Click website "More Information" & "PDF's" for full specification.

For service, calibration & repairs of items inside and outside of the warranty period please submit a quote request via our online support under products & stock - product advice and repairs – Witschi equipment calibration

Code	Description	UOM	Price
W20802	Witschi Proofmaster S Waterproof Tester	EACH	£3,495.00

WATERPROOF TESTING MACHINE PARTS

Parts For Waterproof Testing Equipment

Bergeon Spare Parts - 5555/10

Bergeon 5555/10 (W32292) Waterproof Tester Spare Parts

- Replacement:
- Plexi glass cylinder
 - Tester Rod



Code	Description	UOM	Price
W49758	Plexi Cylinder, Bergeon 5555.10TP	EACH	£78.95
W42375	Tester Rod with Attachment Clip - 5555-10-TC	EACH	£29.95

Bergeon Spare Parts - 5555/98



Bergeon 5555/98 (W1838) Waterproof Tester Spare Parts

- Replacement:
- Gaskets
 - Cylinder
 - Tester Rod

See Website PDF for diagram of parts available

Code	Description	UOM	Price
W30556	Plexi Cylinder, Bergeon 5555.98TP	EACH	£61.95
W7736	Spare Gasket, Bergeon 5555.24	EACH	£4.75
W7737	Spare Gasket, Bergeon 5555.28 (2pcs)	EACH	£4.80
W30551	Spare Gasket, Bergeon 5555.28A	EACH	£3.70

W7738	Spare Gasket, Bergeon 5555.29	EACH	£4.85
W7739	Spare Gasket, Bergeon 5555.30	EACH	£2.65
W7740	Spare Gasket, Bergeon 5555.31	EACH	£2.65
W7741	Spare Gasket, Bergeon 5555.32	EACH	£2.95
W7742	Spare Gasket, Bergeon 5555.33	EACH	£3.50
W7743	Tester Rod With Attachment Clip, Bergeon 5555.TC	EACH	£19.95
W30552	Spare Gasket, Bergeon 5555.98A	EACH	£5.35

Calypso Chamber Parts



Calypso (W1839) Waterproof Tester Spare Chamber Parts

- Diameter given is the inside diameter

Replacement:

- Gaskets
- Cylinder
- Lids

See Website PDF for diagram of parts available

Code	Description	UOM	Price
W37817	Gasket, Flat Chamber Ø60mm (No 45G Spare Part)	EACH	£5.90
W7729A	Gasket, Flat Chamber Ø65mm (No 45G Spare Part)	EACH	£5.90
W37818	Gasket, Flat Chamber Ø80mm (No 45G Spare Part)	EACH	£5.90
W7730	Gasket, O-Ring Lid Ø50mm (No 41G Spare Part)	EACH	£10.50
W37815	Gasket, O-Ring Lid Ø60mm (No 41G Spare Part)	EACH	£9.95
W7729	Gasket, O-Ring Lid Ø80mm (No 41G Spare Part)	EACH	£10.50
W37819	Lid Ø60mm (No 27 Spare Part)	EACH	£51.45
W33192	Lid Ø65mm (No 27 Spare Part)	EACH	£45.95
W37820	Lid Ø80mm (No 27 Spare Part)	EACH	£51.45
W37821	Lid Holder Ø60mm (No 37 Spare Part)	EACH	£61.75
W32857	Lid Holder Ø65mm (No 37 Spare Part)	EACH	£49.95
W37822	Lid Holder Ø80mm (No 37 Spare Part)	EACH	£49.95
W7734A	Main Chamber, Ø50mm (No 44 Spare Part)	EACH	£69.95
W7734C	Main Chamber, Ø65mm (No 44 Spare Part)	EACH	£69.95
W7734D	Main Chamber, Ø80mm (No 44 Spare Part)	EACH	£69.95

Calypso Spare Parts



Calypso (W1839) Waterproof Tester Spare Parts

Replacement:

- Gaskets
- Pump Handle

• Up to 46 Parts

See Website PDF for diagram of parts available

Code	Description	UOM	Price
W7731A	No 1 Spare Part Metal Handle	EACH	£69.95
W33172	No 2 Spare Part	EACH	£16.90
W33173	No 3 Spare Part	EACH	£23.95
W7731	No 4 Spare Part Pump Handle	EACH	£14.80
W33174	No 5G Spare Part Gasket	EACH	£3.70
W33175	No 6 Spare Part	EACH	£24.95
W33176	No 7 Spare Part	EACH	£2.25
W33177	No 8 Spare Part	EACH	£15.95
W33178	No 9 Spare Part	EACH	£15.95
W33179	No10 Spare Part	EACH	£1.50
W33180	No 11 Spare Part	EACH	£1.50
W33181	No 12 Spare Part	EACH	£3.60
W7732	No13G Spare Part Outlet Valve	EACH	£6.95
W7729B	No13 Spare Part Spare Pump Diaphragm Gasket 'New Model'	EACH	£5.85
W33182	No 14 Spare Part	EACH	£45.25
W33183	No 15 Spare Part	EACH	£1.50
W33184	No 16 Spare Part	EACH	£10.75
W33185	No 17 Spare Part Rubber Feet	EACH	£3.70
W33186	No 19 Spare Part	EACH	£37.95
W33187	No 20 Spare Part	EACH	£45.25
W33188	No 21 Spare Part	EACH	£19.65
W33189	No 22 Spare Part	EACH	£52.95
W33190	No 23 Spare Part - Pre 2013	EACH	£20.75
W51648	No 23 Spare Part	EACH	£20.75
W7729C	No 24 Spare Part	EACH	£4.95
W33191	No 25 Spare Part	EACH	£1.50
W39456	No 26G Spare Part	EACH	£5.85
W33193	No 28 Spare Part	EACH	£29.10
W33194	No 29 Spare Part	EACH	£12.50
W7727	No 30 Spare Part Lid Tightening Knob	EACH	£9.95
W33195	No 31G Spare Part Gasket	EACH	£4.95
W33196	No 32G Spare Part Gasket	EACH	£8.35
W33197	No 34 Spare Part Rod Knob	EACH	£10.75
W7733	No 35 Spare Part Internal Chamber Attachment Clip	EACH	£15.50
W55692	No 37 Spare Part Tubing	EACH	£2.95
W33198	No 38 Spare Part	EACH	£3.70
W33199	No 39 Spare Part	EACH	£12.50
W7728	No 40 Spare Part Lid Tightening Knob	EACH	£9.95
W33200	No 42 Spare Part	EACH	£1.50
W33201	No 43 Spare Part Air Escape Knob	EACH	£12.50
W33202	No 43G Spare Part Gasket	EACH	£3.70

Elma Spare Parts



Elma (W1832) Leak Controller Waterproof Tester Spare Parts

Replacement:

- Main Gasket
- Dome

Code	Description	UOM	Price
W7723	Elma Leak Controller Spare Dome	EACH	£39.95
W7725	Elma Leak Controller Spare Main Gasket: '2000 Model' (Round section not flat like old model)	EACH	£5.45

BAMBI 35/20 Compressor

FREE DELIVERY TO UK MAINLAND

Suitable for Bergeon, Elma, Greiner & Witcshi equipment

Ref: C1837, See Page 701

O-Ring Rubber Gaskets

See Page 370

Flat Ring Rubber Gaskets

See Page 376